



List Price Book  
Effective March 1, 2014

evolve systems



# evolve systems



ISO 14001:2004 Registered  
CGSB #006b



the BIFMA sustainability standard  
SCS-SCF0245-4

## PROTECTING THE ENVIRONMENT FOR FUTURE GENERATIONS

Our environmental success story began with the challenge to create an office system that would meet today's business requirements while maintaining a firm commitment to save and protect the environment.

Sustainability became a part of the creative focus and development of Evolve that incorporates the latest technology and design features to provide excellent performance at a competitive price.

As government and industry environment ratings such as LEEDS & Greenguard become more prevalent, Evolve offers designers and architects functional, attractive, and economical office designs that meet these standards.

Evolve is a leader in reducing waste in the manufacturing of its products as well as utilizing recycled materials wherever possible. We make extensive use of recycled plastic and wood waste from other Global factories.

Evolve is committed to the continuous improvement of our environmental systems, the prevention of pollution, and to comply with both the spirit and the letter of all relevant environmental legislation.

Evolve Panels are 100% recyclable at the end of their lifespan. Nothing from an Evolve Panel needs to end up in a landfill.

## PRODUCT INFORMATION

Evolve offers fabrics that are made from 100% recycled polyester, which means less waste going to landfills. These fabrics also reduced the demand for petroleum products, and decrease the environmental impacts of processing those petroleum products into polyester.

Evolve has developed a Panel interior made from 100% recycled wood and polypropylene. Through innovative design and technology, Evolve utilizes waste that would have normally been sent to landfill.

Evolve Panels are insulated with Roxul, a mineral wood insulation made from slag, an inert steel by-product, and basalt rock. Roxul is a high density product that provides maximum sound absorption to reduce noise in the work environment. Roxul insulation is fire resistant, water repellent and will not support the growth of fungi or mildew.

Evolve's epoxy powder coating process involves no liquids and is solvent free. It contains no harmful VOC's or lead. Up to 99% of over sprayed powdered is reclaimed, mixed with virgin powder and reused.



## REFERENCES

Features, Benefits & General Information .....	4-5
Coding an Order .....	6-8
Textiles & Finishes .....	244-248
Panel COM Form .....	249
Panel Fabric Specification Sheet .....	250
Panel Fabric Sample.....	251
Appendix .....	253
Terms & Conditions.....	254-255
Index.....	248-263

## PANELS

Panels – Technical Information.....	10
Panel – Types.....	11-17
Panel – Configurations.....	18-19
Monolithic.....	20-25
Segmented.....	26-31
Partly Glazed.....	32-41
Fully Glazed.....	42-45
Pass-thru Sliding door.....	46-47
Slatwall.....	48-55
Write Board.....	56-57
Laminate.....	58-61
Airflow.....	62-65
Metal Skin.....	66-69
Open.....	70-75
1” Laminate.....	76-79
Door.....	80-81

## EXTENSION MODULES

Extension Modules – Technical Information .....	82
Extension Modules – Types .....	82
Fabric.....	83
Glazed.....	84
Write Board.....	85
Laminate.....	86-87
Airflow.....	88
Open.....	89
Privacy Glass.....	90-91

## PANELS - CONNECTORS

Panels – Technical Information.....	94
Inline Connector.....	95-97
End-of-Run.....	98
Two-Way Post.....	99-101
Three-Way Post.....	102-104
Four-Way Post.....	105-107
One Way Post.....	108-109
Inline Two-Way Post.....	110-111
60 Degree.....	112-114
45 Degree.....	114-115
Upmount End of Run .....	115-116
Extension.....	117-120
Trims.....	121-124

## ELECTRICAL

Electrical – Technical Information .....	126
Electrical – Wire Schematic .....	127
Electrical – Configurations.....	128-129
Power Distribution Housing.....	130
Cables.....	130-131
Power Entry.....	131-132
Post Extension.....	133-134
Task Lights.....	134
LED Lights .....	135-137
Accessories.....	137-138
Power Adaptors.....	139

## WORKSURFACES

Worksurfaces – Technical Information.....	142
Worksurfaces – Configuration .....	143
Worksurfaces – Grain Direction .....	144
Straight Worksurface.....	145-147
Curvilinear Worksurface .....	148
Corner Worksurface .....	149-153
“L” Worksurface.....	154
Transition Worksurface.....	154
Hatchet Worksurface .....	154
“D” Worksurface.....	155
“P” Top .....	155
Straight Wedge Worksurfaces .....	156
Piano Top.....	157
Quarter Round Panel Worksurface .....	158
Radius Worksurface.....	158
“L” Keyboard Worksurface .....	158
“T” Island Worksurface.....	159
Arc Front Worksurface .....	159

Extended Corner Worksurface.....	159
Angle Front Edge Worksurface .....	159
Transaction Worksurfaces .....	160-161
Accessories.....	161-168

## FREESTANDING DESKING

Chassis.....	170-179
Hutch .....	180
Tack Board - Hutch.....	181
Load bar - Hutch.....	182
Corner Legs .....	183-185
Modesty Panel .....	185-187
Desking Hardware.....	187-188

## STORAGE

Storage – Technical Information .....	190-193
Overhead Storage .....	195-204
1200 Series Pedestal .....	205-207
Lateral Files.....	207-209, 216-219, 221
Conversion Kits.....	209-210
Double Wall Cabinets .....	211-214
1200 Series Storage Towers.....	214-215
Storage Cabinets.....	219-220
eStor Storage .....	222-225
Accessories.....	226-229
Key Alike Form .....	230

## ACCESSORIES

Tack Board.....	232
White Marker Board .....	232
Load Bars.....	233-234
Rail Accessories.....	234-236
Keyboard Supports .....	237
Mouse Supports .....	238
Keyboard Rests .....	239
Keyboard Combination Chart .....	239
Monitor Arms .....	240-243
Laptop Support.....	243
Desktop Document Holder .....	244
Foot Rest .....	244
Touch-up Paint Kit.....	244



## PANELS

- NOTE: Panels consist of module frames, module interiors and a variety of skins.

### Panel Information

- All metal components are painted with environmentally friendly epoxy powder.
- Raceway Interiors are coated with recycled epoxy powder.
- The entire Evolve Panel and the processes used to manufacture it are designed to save and protect the environment. Evolve panels are made from recycled materials and are 100% recyclable.
- Panels conform to CGSB and ANSI/BIFMA Standards
- The quality and performance level of these panels have been tested to equal or exceed the requirements of the U.S. Government.
- Classified as Acoustic, these panels meet the acoustical requirements of the U.S. Government with the following ratings:
  - .65 NRC
  - 23 STC
- Panel has a steel frame and is 2 7/8" thick. Corner posts create a panel creep of 3 1/4".
- Leveling Glides extend 2 1/2" high. (Carpet grippers are available, contact Evolve Customer Support).

### Panel Options

- Standard, Beltline and Light\* Segmented Panels are available in the following heights: 30", 42", 54" and 66".
- Standard, Beltline and Light\* Monolithic Panels are available in the following heights: 42", 48", 54" and 66"
  - \* Light panels do not contain a base raceway, therefore the listed heights consider the 6" open space that would have contained a raceway.
- Standard and Light Panel widths come in (8) sizes: 18", 24", 30", 36", 42", 48" 54" and 60"
- Beltline Panel widths come in (7) sizes: 24", 30", 36", 42", 48", 54" and 60". The 6" Power Belt Module is metal with knockouts on both sides.
- Beltline Panel with Chimney widths come in (2) sizes: 36" and 42".

### Panel Skin Options

- Acoustic Fabric (Tackable), Glazed, Open, Laminate, Whiteboard, Metal, Air Flow, Slat

### Panel Extension Modules

- Attaches to the top of Standard, Beltline or Light panels.
- Offered in 6", 12", 18" and 24" heights
- Can be stacked in an excess of 14'-0". (Contact the Evolve Specification Department regarding additional support required.)

## Extension Module Options

- Fabric, Glazed, Open, Laminate, Whiteboard and Airflow. Laminate and Whiteboard available in single and double sided.

## Panel Reconfiguration

- Panels can be modified on site by replacing fabric modules with Glazed, Open, Laminate, Whiteboard or Air Flow at any time after the initial installation\*.
- All panel types existing on site can have their height altered by replacing the vertical liners (on each side of the panel) and adding or subtracting modules\* as required.
- Fabric can be replaced easily; using pre-cut segments of fabric, a drawstring (C-Jex) is sewn in around the edges. Then a rubber spline is used to 'screen' the fabric in place.
- Panels can be removed from the workstation, without having to remove an overhead or worksurface.
- Corner connectors can be converted from 2-way to 3-way, etc., by attaching an in-line connector with one screw.
- The Power Belt Module for the Beltline Panels cannot be relocated.

\*Contact Evolve Customer Support for information on field installed modules (they are available in heights of 6", 12" and 24")

## VOICE/DATA AND ELECTRICAL POWER

- NOTE: Panels and Electric components are CSA/UL approved. Tools are not required to install electrical in the Evolve Panel System.

### Voice and Data can be run at the following levels:

- Standard Panels—Base of the panel.
- Beltline Panels—Base, Beltline of the panel.
- Beltline Light Panels—Beltline of the panel.

### Electric can be run at the following levels:

- Standard Panels—Base raceway
- Beltline Panels—Base and/or Beltline raceway
- Light Panels—Do not contain a raceway for electric.
- Beltline Light Panels—Beltline raceway

### Additional Data and Electric Options

- A panel mounted power bar can be mounted on-module at any level and contains a 14' cord.
- Desktop modules are available to install in the worksurface scoop for electric and data.
- 6" Vertical Panel provides electric and data above the worksurface and electric just below the worksurface.

## Electric Information

- Electric can be run in any raceway whether it is at the base or Beltline.
  - 8-Wire, 4-Circuit Capability
  - 2 Utility + 2 Dedicated Circuits
  - 10 Gauge (oversized) Neutrals.
- All circuits can support up to 20 amps (15 CSA).

## Raceway Information

- Raceway knockouts sizes conform to the ANSI/TIA/EIA Furniture Opening Standard of 1.38" x 2.71" at the base and Beltline.
- Panels 24" wide include raceway covers with one knockout.
- Panels 30" wide include raceway covers with two knockouts.
- Panels 36"-60" wide include raceway covers with three knockouts.
- Standard data face mount plates can be used without the need of adapter plates (supplied by others).

### Cabling Capacities

(calculations below are based on CAT5 cables)

### Base Raceway – for Standard and Beltline Panels

- Without Electric – 140 Cables
- With Electric – 48 Cables

### Beltline Raceway – for Beltline and Light Beltline Panels

- Without Electric – 65 Cables
- With Electric – 54 Cables

### Panel Connectors - 45 Degree Connectors Posts

- Without Electric – 20 Cables
- With Electric – 6 Cables

### Panel Connectors - 60 Degree Connector Posts

- Without Electric – 20 cables
- With Electric – 6 Cables

### Post Extension - 90 Degree Post

- Without Electric - 45 Cables
- With Electric - 25 Cables

### Post Extension - 45 Degree Post

- Without Electric - 20 Cables
- With Electric - 6 Cables

### Post Extension - 60 Degree Post

- Without Electric - 20 Cables
- With Electric - 6 Cables

## WORKSURFACES

- NOTE: Worksurfaces come in a variety of shapes and sizes.

### Worksurface Options

- Standard worksurface depths are 18"d, 24"d and 30"d.
- Standard worksurface widths range from 24"w – 84"w standard depending on the shape.



## Worksurface Laminate Options

- Thermally Fused – 1" thick
- High Pressure – 1-1/16" thick
- High Pressure – 1-7/16" thick
- Wood Veneer – Contact Customer Support for Quotes

## Worksurface Information

- Cable scoops are located in the back of each worksurface to route power and data cables
- Depth from center of scoop to panel is 1-1/8".
- Once installed there is a 3/8" gap between the worksurface and the panels for additional cabling needs.
- Custom sizes are available, contact Customer Support for Quotes.
- Metal inserts are standard for a metal to metal connection between the worksurface and the supporting hardware. This will allow product to be reconfigured many times and still perform.
- All worksurfaces utilize balanced construction.

## STORAGE

### Pedestals

- Available as Worksurface Supporting, Freestanding and Mobile.
- Mobile pedestals are available with or without a cushion. Mobile pedestals with a cushion can have an upholstery fabric applied to them.
- Standard Pedestal Depths are 18"d, 19"d, 23"d, 24"d, 29"d and 30"d
- Pedestal widths are 15"w. Please note maximum extension of pedestal glide is 1".

### File Drawers

- 150 lb Full Extension Slides
- Full height drawer sides are standard on all File drawers which enables the hanging of files from the drawer side so no extra hardware is necessary. File drawers accept legal, letter and metric sized files.

### Box Drawers

- 75 lb Single Action Slides

### Drawer Information

- Steel construction guarantees the performance of the product over the long term.
- Welded joints with a full top, back and base ensure that the pedestal will sit square and adequately support the worksurface where necessary.
- Double wall drawer face
- 20 gauge steel
- Metal roller ball bearing slides
- Adjustable glides are accessible from the inside of the pedestal.
- Standard positive and secure locking system.
- Epoxy powder coated.
- Locks can be keyed alike or master keyed\*. Please note Key list(s) required to key alike.
- \*Master Key must be ordered separate.

- Standard recessed handle offers uncluttered aesthetic.

### Lateral Files

- All lateral files are 18" deep
- Standard widths are 30"w, 36"w and 42"w.
- Standard EV12 Heights are 27.75"h, 40.5"h, 54"h and 65.88"h.
- Available with fixed front drawers, receding doors with roll-out shelf, and half height drawers (See page 184 for more information Lateral File)

### Lateral File Information

- Drawer anti-locking system
- Three Stage, anti-bounceback suspension
- Receding door features 16 gauge, spring loaded hinges
- Premium drawer slides with black zinc coating for smoother, quieter motion.
- Pre-Installed file bars
- 18-20 gauge steel
- Adjustable glides are accessible from the inside of the lateral file. Please note maximum extension for lateral glide is 5/8"

### Storage Towers

- Features all metal construction and a choice of 20 different configurations.
- Heights include 50"h, 54"h and 65.875"h. 42"h and 48"h available upon request.
- 24"w x 24"d
- Side shelving available.

### Bookcases and Storage Cabinets

- Features all metal construction.
- Available in widths of 30"w, 36"w and 42"w.
- Heights include 27.75"h, 40.5"h, 54"h and 65.88"h.

### eStor Cabinets

- Features all metal construction and a choice of 18 different configurations.
- Available in widths of 30"w and 36"w.
- Standard height is 54"h.
- Allows for electric to pass through the base of the cabinet.

## Overhead Storage

- Standard widths include 24"w (not available on all units), 30"w, 36"w, 42"w, 48"w, 54"w and 60"w. Please note ADA and Double Wall Overheads are not available in 24"
- Standard heights range from 12"h to 17.5"h.
- Overhead Options
- Flat Front 12" Flipper Door
- Full Pull 13" Flipper Door
- Full Pull Double Wall Flipper Door (also available with shelf option)
- Full Pull 16" Flipper Door (door retracts inside cabinet)
- Sliding glass doors
- ADA Compliant Overhead with soft close mechanism
- High and Low Profile Shelf
- A magnetic whiteboard is available for metal front overheads.

## WARRANTIES AND PERFORMANCE

- A Lifetime Warranty
- Non Obsolescence Warranty
- Reduced cost of assembly and reconfiguration
- ISO9001:2000 Registered
- ISO14001:2004 Registered
- GreenGuard Certified
- ANSI/BIFMA CGSB testing on all products
- For piece of mind over the long term, we cover you with a comprehensive warranty that is supported by our dealer network.
- Some installation companies claim that the Evolve Panels System can be installed in half the time it takes to install most of our competitor's segmented panels. This cost saving can amount to thousands of dollars over the lifetime of our furniture.
- Your assurance of consistent quality to an international standard. Evolve Systems is committed to design, manufacture and distribute superior quality office furniture, which meets or exceeds the requirements of our customers.
- Confirmation that Evolve is committed (1) to providing product that, through their entire life cycle, minimize negative environmental impacts on the environment, (2) to continuous improvement to our environmental systems and programs and (3) to comply to all relevant environmental legislation and regulations.
- Evolve Systems can help a company meet LEED requirements for office furniture.
- Evolve components are tested to the highest standard in the industry. This is your assurance of quality and longevity.

Evolve products have been coded using alphas that correspond with the product name. This creates an easy-to-remember code. The following breaks down the coding logic and highlights the required code components needed to order within each product category.

## PANELS

### Example:

### Product: Segmented Panel

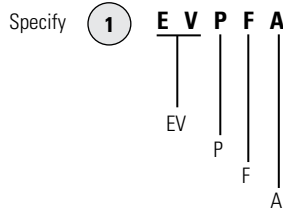

Base Code found on the product page to the left of the product name and a simple product illustration.

**EV**olve product line

**P**anel category

**F**abric-covered or partly fabric-covered Panel

**A**coustic Panel  
(EVPF P – represents Premium Acoustic)

**2** EVPFA**6648**

Panel size offering. Listed on every product page with price listing.  
Note: Additional dimensions are provided for most products on the far right hand side of each page. These dimensions are not required in the ordering code.

**3** EVPFA6648 –**BLK**

Finish code for frame. See Textiles & Finishes pages 240-241.

To specify fabric for an Evolve Panel, please note:

**4** EVPFA6648–BLK–**B84A**

Fabric code for all modules on both sides of the Panel\*.  
See Textiles & Finishes pages 240-241.

**\* NOTE:** If different fabrics are to be included on an Evolve Panel, please use the following ordering format. **Start at the bottom** of one side of a Panel and work to the top module of that Panel. Then start the process over on the other side of the Panel. As an example:

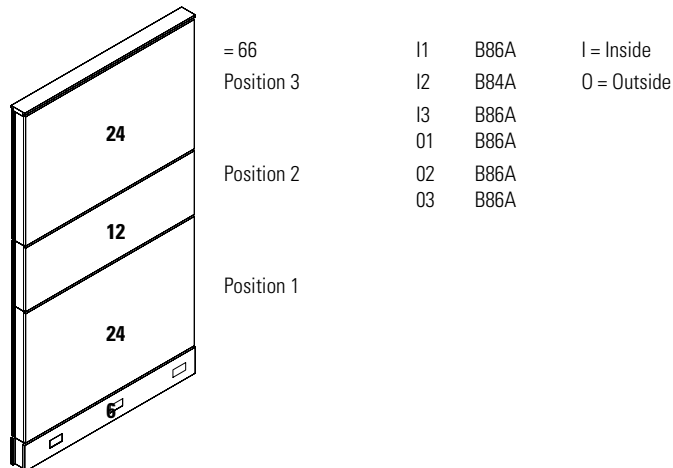

**ELECTRICAL**

**Example: Product: Pass-Through Cables**

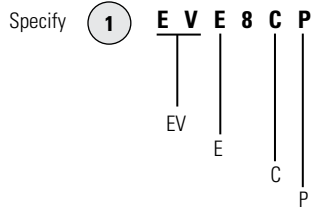

Base Code found on the product page to the left of the product name and a simple product illustration.

**EV**olve product line

**E**lectrical category

**C**able Panel.

**P**ass-Through.

**2** EVE8CP**40**

Product size offering – length. Listed on every product page with price listing. Note: Additional dimensions are provided for most products on the far right hand side of each page. These dimensions are not required in the ordering code.

**WORKSURFACES**

**Example: Product: Curvilinear Worksurface - Left**

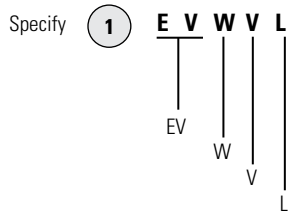

Base Code found on the product page to the left of the product name and a simple product illustration.

**EV**olve product line

**W**orksurface category

Cur**V**ilinear shape

**L**eft hand configuration

**2** EWWL**3042**

Worksurface size offering. Listed on every product page with price listing. Note: Additional dimensions are provided for most products on the far right hand side of each page. These dimensions are not required in the ordering code.

**3** EWWL3042–**T431**

Laminate code for surface. See Textiles & Finishes pages 240-241.

**4** EWWL3042–T431–**CHR**

PVC code for trim. See Textiles & Finishes pages 240-241.

**WORKSURFACES - HARDWARE**

**Example:**

**Product:**

**End Panel**

Specify

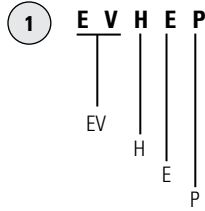

Base Code found on the product page to the left of the product name and a simple product illustration.

**EV**olve product line

**H**ardware category

**E**nd Panel.

End **P**anel.

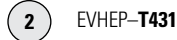

Laminate code for End Panel. See Textiles & Finishes pages 240-241.

**STORAGE**

**Example:**

**Product:**

**Box, Box, File Pedestal**

Specify

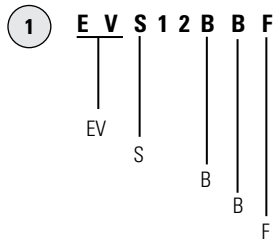

Base Code found on the product page to the left of the product name and a simple product illustration.

**EV**olve product line

**S**torage category

**B**ox drawer

**B**ox drawer

**F**ile drawer

**ACCESSORIES**

**Example:**

**Product:**

**White Board**

Specify

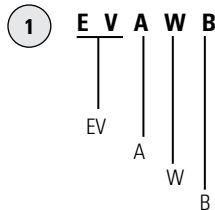

Base Code found on the product page to the left of the product name and a simple product illustration.

**EV**olve product line

**A**ccessories category

**W**hite Board

**W**hite Board





panels

## TECHNICAL FEATURES OF EVOLVE PANELS:

- Evolve Panels are 2 7/8" thick.
- An aluminum low profile top cap is included with the panel.
- Base Raceway will allow for 140 data cables without electrical, or 48 data cables with electrical.
- Beltline Raceway will allow for 65 data cables without electrical or 54 data cables with electrical.
- 90 degree post extension will allow for 45 data cables without electric and 25 data cables with electric.
- Raceway knockout openings are 1.38" x 2.71".
- Acoustic Rating: .65 = NRC - Noise Reduction Coefficient
- STC: 23 = Sound Transmission Coefficient

## BASIC FEATURES OF EVOLVE PANELS:

- Evolve Segmented Panels are available in four (4) basic heights: 30", 42", 54" and 66"; and eight (8) widths: 18", 24", 30" 36", 42", 48", 54" High and 60".
- Evolve Monolithic Panels are available in four (4) basic heights: 42", 48", 54" and 66"; and eight (8) widths: 18", 24", 30" 36", 42", 48", 54" and 60".
- Evolve Panels must include the same segmentation on both sides of the panel. Cannot be Monolithic on one side and Segmented on the other.
- Opposite sides of each Fabric Module may have a different fabric within the same grade at no upcharge.
- If different grades of fabric are used on one panel, the entire panel must be priced at the highest grade.
- There is no panel creep in a straight Panel-to-Panel configuration; however, a corner post (2, 3, 4 way) will add 3.25" inches to a panel run.
- All Fabric Acoustic Panels (EVPFA) are composed of a 6" raceway module and a 24" base-height module which create the EVPFA30. Subsequent heights are created by adding either a 12" high module to create an EVPFA42 or a 24" high module to create an EVPFA54. The addition of both 12" and 24" modules creates a EVPFA66.
- In contrast, a Premium Panel (EVFPF) is composed of a 6" raceway module, a 24" base-height module and either two (2) or three (3) 12" modules which make up the two premium heights: EVFPF54 and EVFPF66.
- All Panels available with Aluminum trim as a standard option.
- Individual fabric covered acoustic modules incorporated into a rigid steel frame.
- Raceway covers included with panels
- Beltline Panels contain a 6" Power Belt Module that is metal with knockouts on both sides.

## BASIC FEATURES OF EXTENSION MODULES:

- Stackability: Evolve Panels can be increased in height in 6", 12", 18" or 24" increments. See Extension Module (pages 82-90) for part numbers.
- Panel Extension Modules stack on the top of a Panel.
- Modules can be stacked to add privacy or divide space.
- Opposite sides of a fabric module may have a different fabric within the same grade at no upcharge.
- If different grades of fabric are used on one Panel, the entire Module must be priced at highest grade.

## GENERAL WARRANTY INFORMATION:

- Panel and tackboard textiles, adjustable keyboard mechanisms, tasklights and electrical devices = ten (10) Years
- Other parts = Lifetime Warranty



MONOLITHIC PANELS - PAGES 20-25

Monolithic Panel

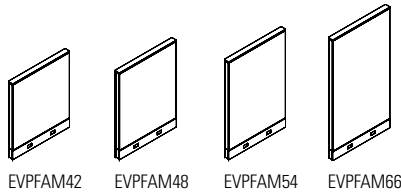

Monolithic Light Panel

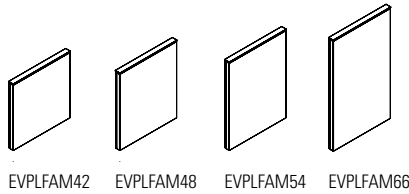

Monolithic Beltline Powered Panel

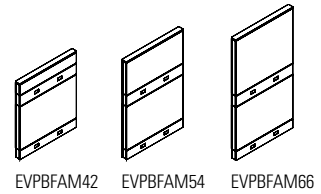

Monolithic Beltline Powered Light Panel

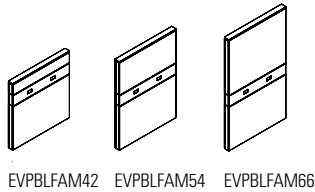

Monolithic Beltline Powered Chimney Panel

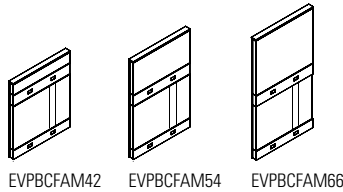

Chimney Jumper Cable Kit

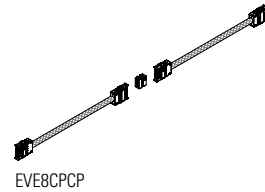

Monolithic Beltline Non-Powered Panel

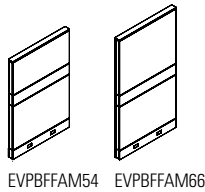

Monolithic Beltline Non-Powered Light Panel

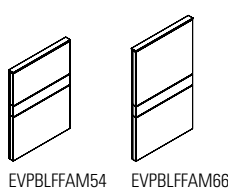

SEGMENTED PANELS - PAGES 26-31

Segmented Panel

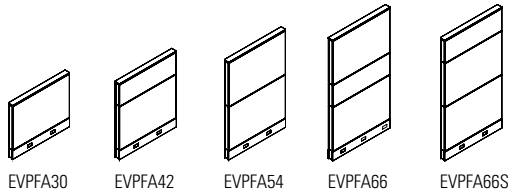

Segmented Light Panel

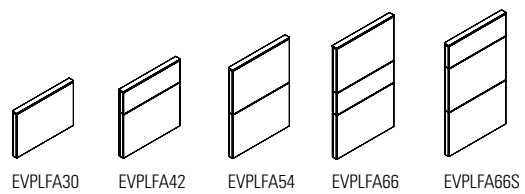

Segmented Premium Panel

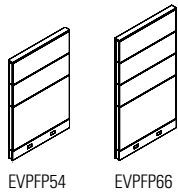

Segmented Premium Light Panel

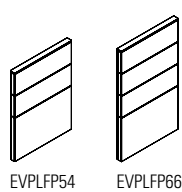

Segmented Beltline Powered Panel

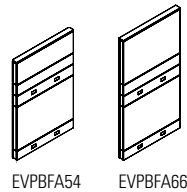

Segmented Beltline Powered Light Panel

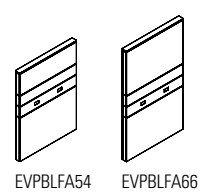

Segmented Beltline Powered Chimney Panel

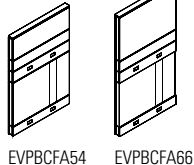

Chimney Jumper Cable Kit

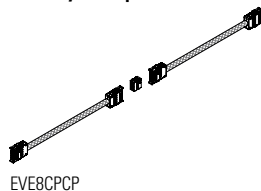

Segmented Beltline Non-Powered Panel

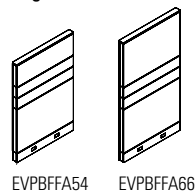

Segmented Beltline Non-Powered Light Panel

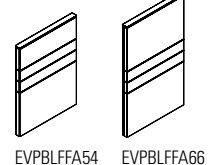

PARTLY GLAZED - TEMPERED GLASS PANELS - PAGES 32-41

Monolithic 12"H Glazed Panel

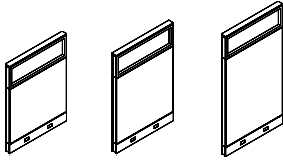

EVPMGTU48 EVPMGTU54 EVPMGTU66

Monolithic 12"H Glazed Light Panel

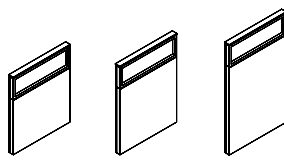

EVPLMGTU48 EVPLMGTU54 EVPLMGTU66

Segmented 12"H Glazed Panel

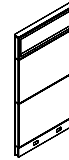

EVPPGTU66

Segmented 12"H Glazed Light Panel

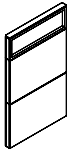

EVPLFGTU66

Segmented 12"H Glazed Premium Panel

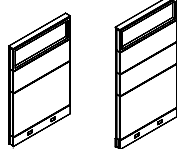

EVPPFGTU54 EVPPFGTU66

Segmented 12"H Glazed Premium Light Panel

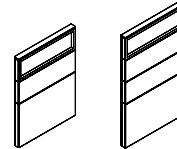

EVPLFGTU54 EVPLFGTU66

Partly Glazed Panel

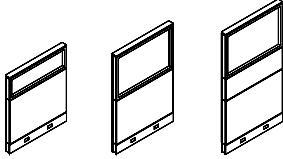

EVPGT42 EVPGT54 EVPGT66

Partly Glazed Light Panel

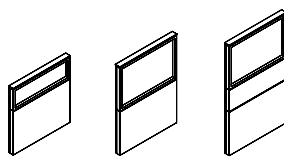

EVPLFGT42 EVPLFGT54 EVPLFGT66

Partly Glazed Panel - 36"H



EVPGTX66

Partly Glazed Light Panel - 36"H

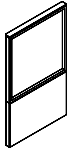

EVPLFGTX66

Partly Glazed Beltline Powered Panel

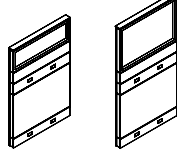

EVPPBFGT54 EVPPBFGT66

Partly Glazed Beltline Powered Light Panel

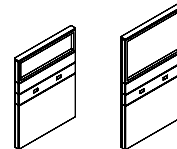

EVPPBFGT54 EVPPBFGT66

Partly Glazed Beltline Powered Chimney Panel

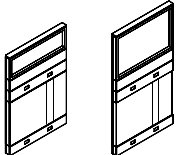

EVPPBCFGT54 EVPPBCFGT66

Chimney Jumper Cable Kit

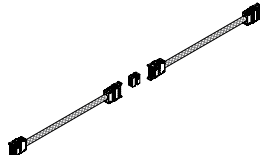

EVE8CPCP

Partly Glazed Premium Panel

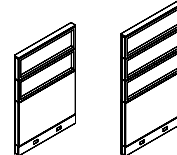

EVPPFGT54 EVPPFGT66

Partly Glazed Premium Light Panel

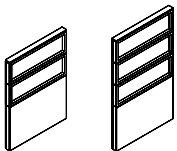

EVPLFPGT54 EVPLFPGT66



FULLY GLAZED - TEMPERED GLASS PANELS - PAGES 42-45

Fully Monolithic Panel

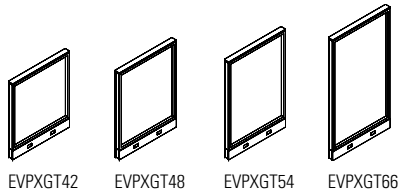

Fully Monolithic Light Panel

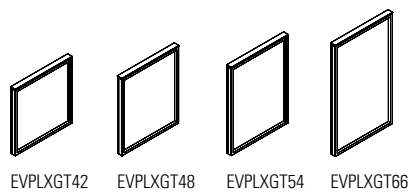

Fully Glazed Segmented Panel

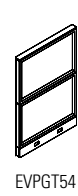

Fully Glazed Segmented Light Panel

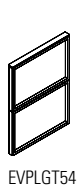

Fully Glazed Premium Panel

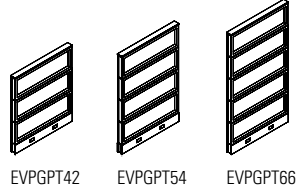

Fully Glazed Premium Light Panel

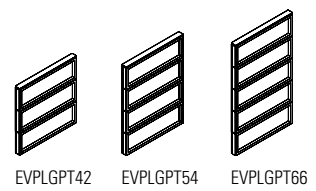

PASS-THRU SLIDING DOOR - PAGES 46-47

Pass-Thru Sliding Door Glazed Panel

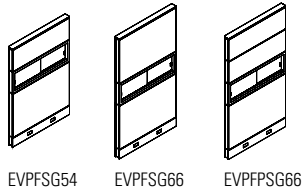

Fabric Glazed Pass-Thru Sliding Door Panel

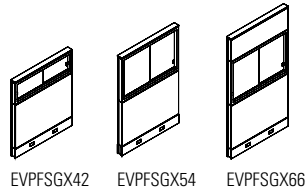



SLATWALL PANELS - PAGES 48-55

Slatwall Panel - Single Sided

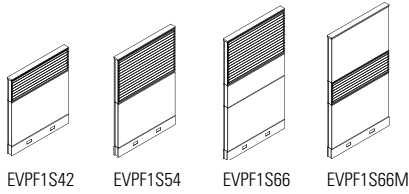

Slatwall Light Panel - Single Sided

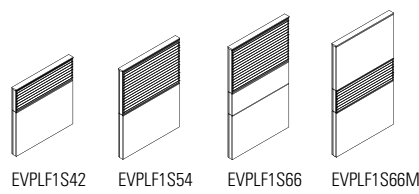

Slatwall Panel - Double Sided

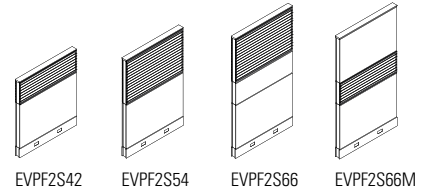

Slatwall Light Panel - Double Sided

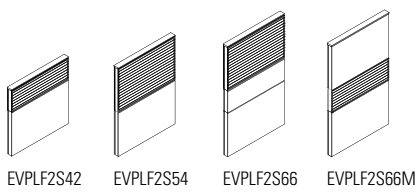

Frameless Slatwall Panel - Double Sided

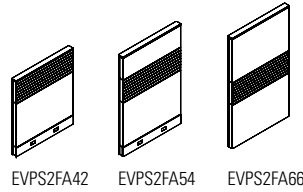

Frameless Slatwall Beltline Powered Panel - DS

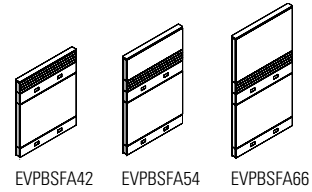

Frameless Slatwall Beltline Powered Light Panel - DS

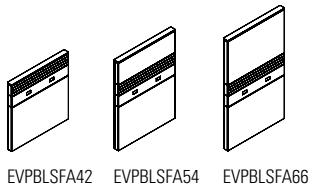

Frameless Slatwall Beltline Powered Chimney Panel - Double Sided

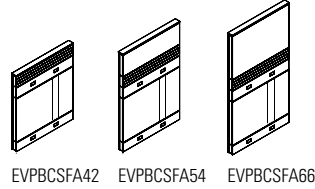

Chimney Jumper Cable Kit

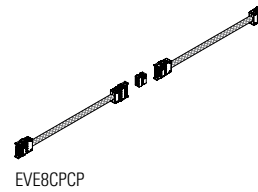

WRITE BOARD PANELS - PAGES 56-57

Write Board Panel - Single Sided

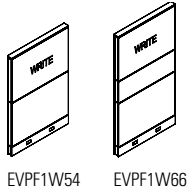

Write Board Light Panel - Single Sided

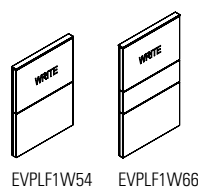

Write Board Panel - Double Sided

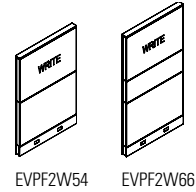

Write Board Light Panel - Double Sided

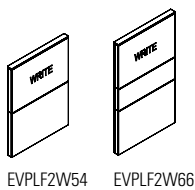

LAMINATE PANELS - PAGES 58-61

Laminate Panel - Single Sided

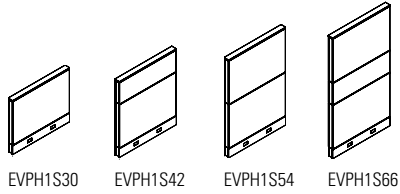

Laminate Light Panel - Single Sided

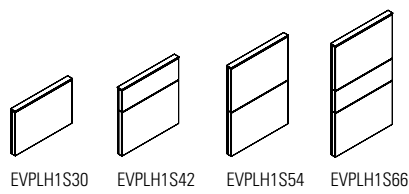

Laminate Panel - Double Sided

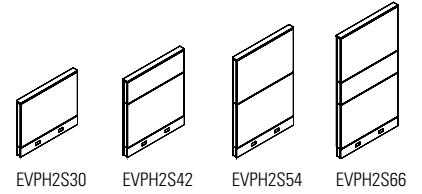

Laminate Light Panel - Double Sided

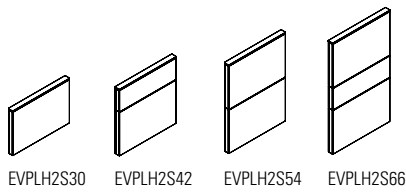

AIRFLOW PANELS - PAGES 62-65

Airflow Panel

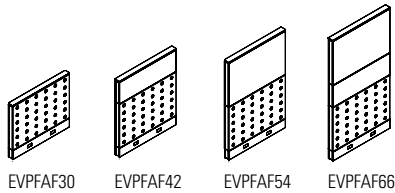

Airflow Light Panel

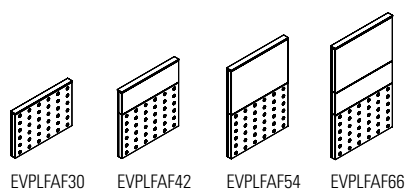

Airflow Premium Panel

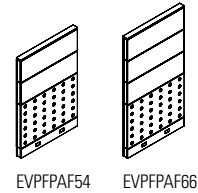

Airflow Premium Light Panel

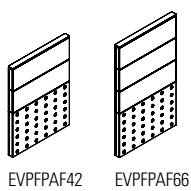

Airflow Middle Premium Panel

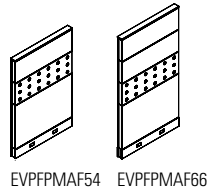

Airflow Middle Premium Light Panel

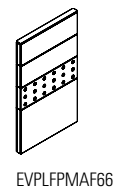

METAL SKIN PANELS - PAGES 66-69

Metal Skin Panel - Single Sided

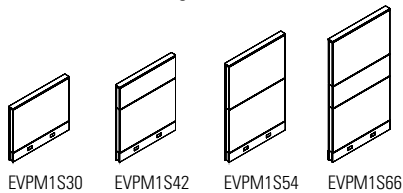

Metal Skin Light Panel - Single Sided

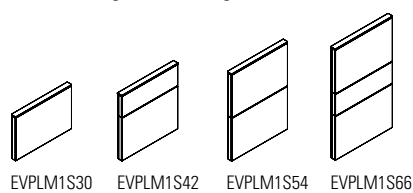

Metal Skin Panel - Double Sided

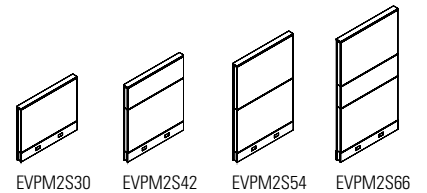

Metal Skin Light Panel - Double Sided

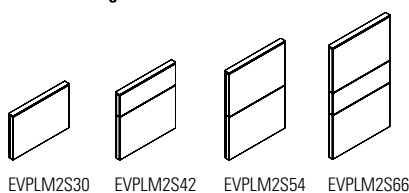

OPEN PANELS - PAGES 70-75

Open Bottom Panel

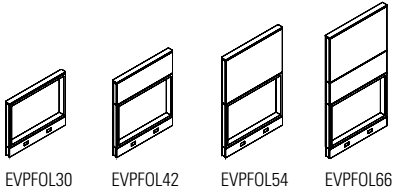

Open Bottom Light Panel

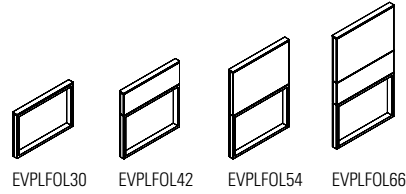

Open Bottom Premium Panel

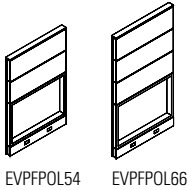

Open Bottom Premium Light Panel

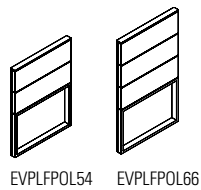

Open Middle Panel - 12"H Opening

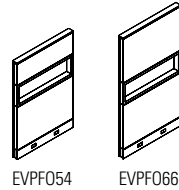

Open Middle Light Panel - 12"H Opening

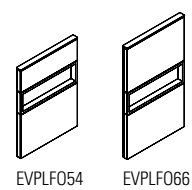

Open Middle Premium Panel - 12"H Opening

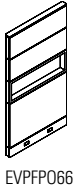

Open Middle Premium Light Panel - 12"H Opening

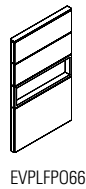

Open Middle Panel - 24"H Opening

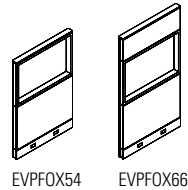

Open Middle Light Panel - 24"H Opening

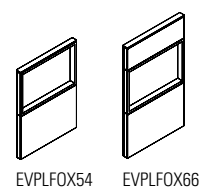

1" LAMINATE PANELS - PAGES 76-79

1" Laminate End Panel

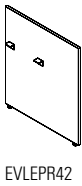

1" Laminate Middle Panel



1" Laminate End Panel w/ Accessory Rail

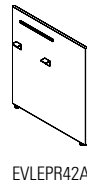

1" Laminate Middle Panel w/ Accessory Rail

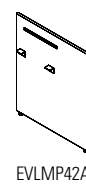

Double Inline Panel Connector

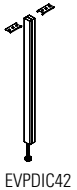

Beltline DoubleInline Panel Connector

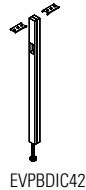

Double Inline Connector Trim

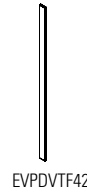

Double Inline Panel Connector Top Trim - Aluminum

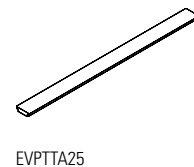

DOOR PANELS - PAGES 80-81

Door Panel - Solid

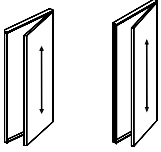

EVPDS84

EVPDS90

Knob Lock Set



EVPDSL01

Lever Lock Set



EVPDSL02

Sliding Door Lock

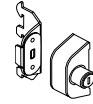

EVPDSLLOCK

Sliding Privacy Door

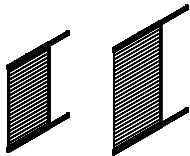

EVPDSL66

EVPDSL81

Mini Panel Kit

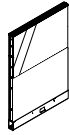

EVMPK02

High Profile Foot



EVHFF01

This page provides an exploded view of a sample configuration highlighting each **Panel** component required when specifying this configuration.

**Components**

- |  |  |
|--|--|
| <p><b>A.</b> EVPERA66 End-of-Run Kit (Wall mount)<br/>Note: adds 1" to the width of a Panel Run.</p> <p><b>B.</b> EVPFA6636 Segmented Panel</p> <p><b>C.</b> EVPIC66 Inline Panel Connector</p> <p><b>D.</b> EVPCPA266 Two-Way Corner Post<br/>Note: Trim kit included.<br/>Post Connectors can be custom manufactured with or without slots. Contact your Evolve Customer Support Representative for a special quote.</p> | <p><b>E.</b> EVPVC66 Variable-Height Connector<br/>Note: Connector height must reference taller Panel.</p> <p><b>F.</b> EVPTVA24 Panel Trim Variable-Height</p> <p><b>G.</b> EVPFA4236 Segmented Panel</p> |
|--|--|

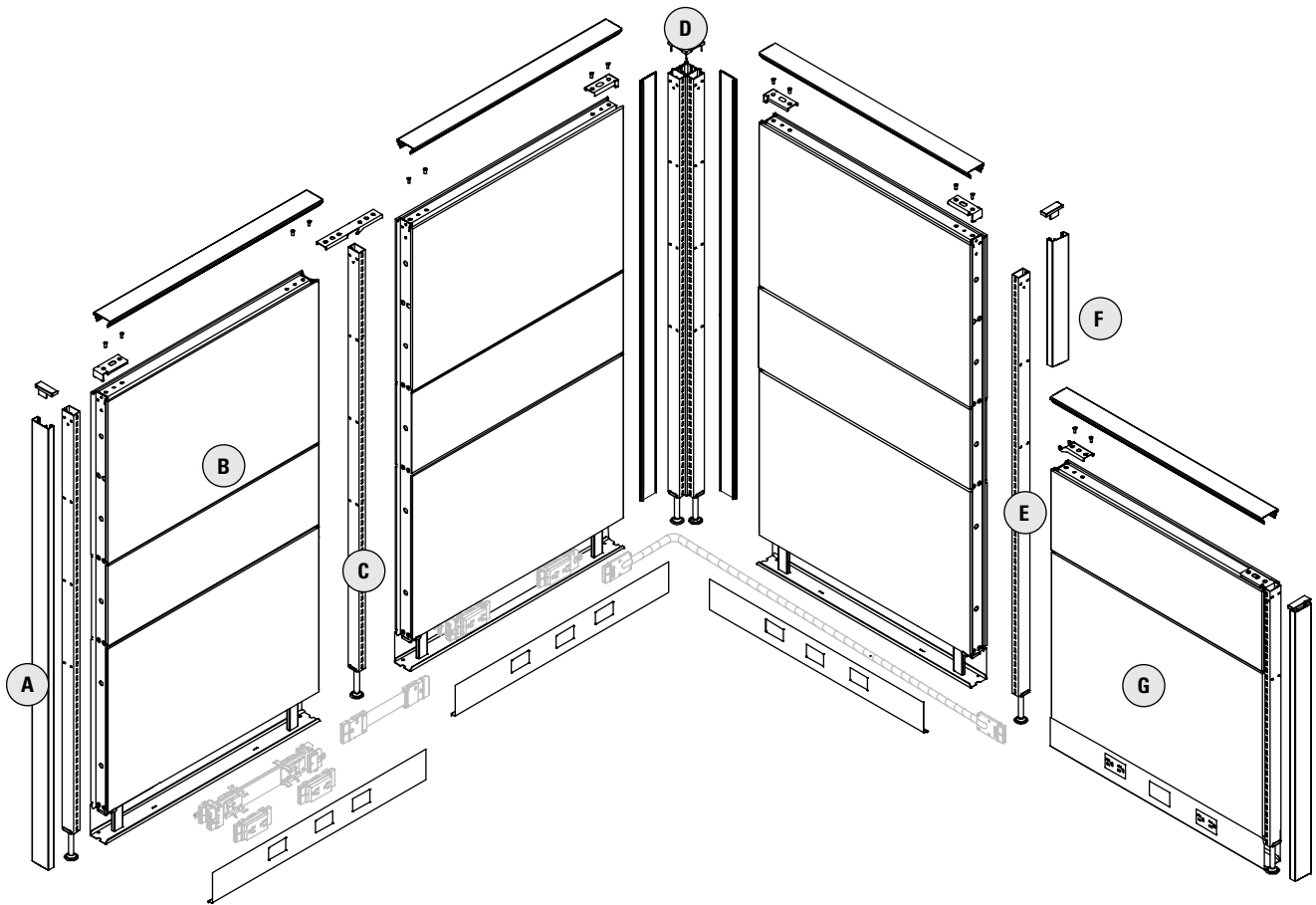



This page provides an exploded view of a sample configuration highlighting each **Beltline Power Panel** component required when specifying this configuration.



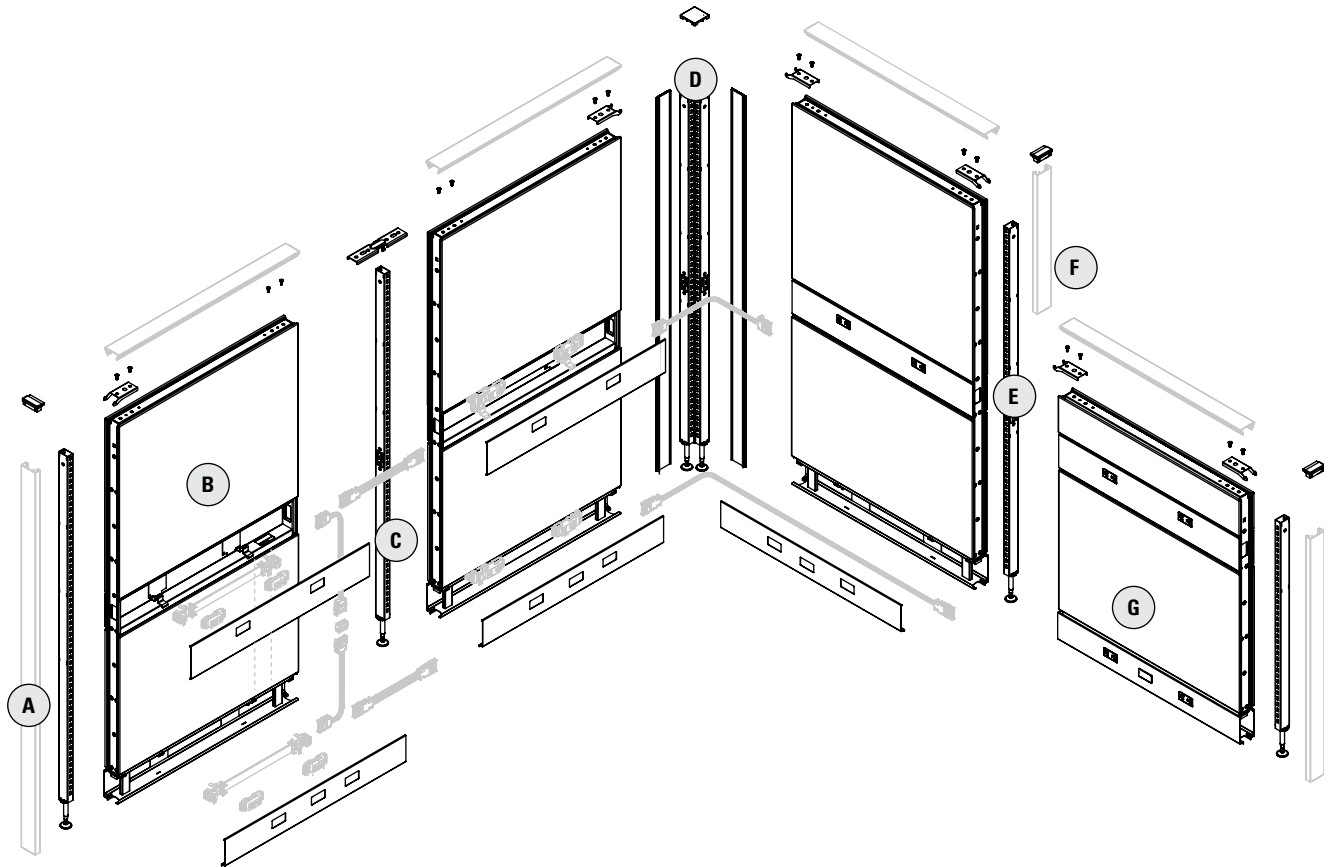

**Components**

- |   |   |
|---|---|
| <p><b>A.</b> EVPERA66 End-of-Run Kit (Wall mount)<br/>Note: adds 1" to the width of a Panel Run.</p> <p><b>B.</b> EVPBCFAM6636 Monolithic Beltline Powered Chimney Panel</p> <p><b>C.</b> EVPBIC66 Inline Panel Connector for Beltline Electric Panels</p> <p><b>D.</b> EVPBIPA266 Two-Way Corner Post for Beltline Electric Panels<br/>Note: Trim kit included.<br/>Post Connectors can be custom manufactured with or without slots. Contact your Evolve Customer Support Representative for a special quote.<br/>Note: All beltline post connectors come with PVC covers to install at beltline height on all sides.</p> | <p><b>E.</b> EVPVC66 Variable-Height Connector for Beltline Electric Panels<br/>Note: Connector height must reference taller Panel.</p> <p><b>F.</b> EVPTEA24 Panel Extension Trim</p> <p><b>G.</b> EVPBFAM4236 Monolithic Beltline Powered Panel</p> |
|---|---|

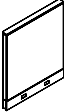

**EVPFAM - MONOLITHIC PANEL**





- Monolithic Panel incorporates fabric modules within a solid steel frame.
- Fabric covered modules are tackable and acoustical.
- Opposite sides of each panel may have a different fabric within the same grade at no upcharge.
- If different grades of fabric are used on one panel, the entire panel must be priced at highest grade.
- An aluminum low profile top cap is included.
- Stackability: Evolve panels can be increased in height in 6”H, 12”H, 18”H or 24”H increments. See Extension Module (pages 82-90) for part numbers.

	DESCRIPTION	PRODUCT CODE	LIST PRICE		DIMENSIONS/INCHES		
			Gr1	Gr2	H	W	D
	Monolithic Panel - 42" High	EVPFAM4218	244	266	42	18	2 7/8
		EVPFAM4224	260	287	42	24	2 7/8
		EVPFAM4230	299	331	42	30	2 7/8
		EVPFAM4236	318	355	42	36	2 7/8
		EVPFAM4242	352	397	42	42	2 7/8
		EVPFAM4248	384	433	42	48	2 7/8
		EVPFAM4254	422	476	42	54	2 7/8
	Monolithic Panel - 48" High	EVPFAM4818	247	269	48	18	2 7/8
		EVPFAM4824	272	300	48	24	2 7/8
		EVPFAM4830	314	347	48	30	2 7/8
		EVPFAM4836	343	380	48	36	2 7/8
		EVPFAM4842	382	426	48	42	2 7/8
		EVPFAM4848	415	464	48	48	2 7/8
		EVPFAM4854	459	514	48	54	2 7/8
	Monolithic Panel - 54" High	EVPFAM5418	250	272	54	18	2 7/8
		EVPFAM5424	275	302	54	24	2 7/8
		EVPFAM5430	320	352	54	30	2 7/8
		EVPFAM5436	355	394	54	36	2 7/8
		EVPFAM5442	397	441	54	42	2 7/8
		EVPFAM5448	432	481	54	48	2 7/8
		EVPFAM5454	474	530	54	54	2 7/8
	Monolithic Panel - 66" High	EVPFAM6618	309	331	66	18	2 7/8
		EVPFAM6624	339	367	66	24	2 7/8
		EVPFAM6630	382	416	66	30	2 7/8
		EVPFAM6636	445	483	66	36	2 7/8
		EVPFAM6642	499	543	66	42	2 7/8
		EVPFAM6648	541	589	66	48	2 7/8
		EVPFAM6654	602	655	66	54	2 7/8
EVPFAM6660	662	721	66	60	2 7/8		



**EVPLFAM - MONOLITHIC LIGHT PANEL**

- Monolithic Light Panel incorporates fabric modules within a solid steel frame.
- There is no base raceway in Light Panels to accommodate electrical.
- Light Panel Connectors must be used in conjunction with Light Panels.
- Fabric covered modules are tackable and acoustical.
- Opposite sides of each panel may have a different fabric within the same grade at no upcharge.
- If different grades of fabric are used on one panel, the entire panel must be priced at highest grade.
- An aluminum low profile top cap is included.
- Stackability: Evolve Light panels can be increased in height in 6”H, 12”H, 18”H or 24”H increments. See Extension Module (pages 82-90) for part numbers.

	DESCRIPTION	PRODUCT CODE	LIST PRICE		DIMENSIONS/INCHES		
			Gr1	Gr2	H	W	D
	Monolithic Light Panel - 42” High	EVPLFAM4218	233	253	42	18	2 7/8
		EVPLFAM4224	246	273	42	24	2 7/8
		EVPLFAM4230	283	315	42	30	2 7/8
		EVPLFAM4236	302	339	42	36	2 7/8
		EVPLFAM4242	336	377	42	42	2 7/8
		EVPLFAM4248	365	412	42	48	2 7/8
		EVPLFAM4254	402	452	42	54	2 7/8
		EVPLFAM4260	435	490	42	60	2 7/8
	Monolithic Light Panel - 48” High	EVPLFAM4818	236	256	48	18	2 7/8
		EVPLFAM4824	258	284	48	24	2 7/8
		EVPLFAM4830	299	330	48	30	2 7/8
		EVPLFAM4836	325	361	48	36	2 7/8
		EVPLFAM4842	363	405	48	42	2 7/8
		EVPLFAM4848	394	441	48	48	2 7/8
		EVPLFAM4854	437	488	48	54	2 7/8
		EVPLFAM4860	460	516	48	60	2 7/8
	Monolithic Light Panel - 54” High	EVPLFAM5418	237	258	54	18	2 7/8
		EVPLFAM5424	261	286	54	24	2 7/8
		EVPLFAM5430	304	336	54	30	2 7/8
		EVPLFAM5436	339	375	54	36	2 7/8
		EVPLFAM5442	377	419	54	42	2 7/8
		EVPLFAM5448	410	457	54	48	2 7/8
		EVPLFAM5454	450	504	54	54	2 7/8
		EVPLFAM5460	493	550	54	60	2 7/8
	Monolithic Light Panel - 66” High	EVPLFAM6618	295	315	66	18	2 7/8
		EVPLFAM6624	321	348	66	24	2 7/8
		EVPLFAM6630	363	396	66	30	2 7/8
		EVPLFAM6636	422	459	66	36	2 7/8
		EVPLFAM6642	474	516	66	42	2 7/8
		EVPLFAM6648	514	560	66	48	2 7/8
		EVPLFAM6654	571	623	66	54	2 7/8
		EVPLFAM6660	628	686	66	60	2 7/8

**EVPBFAM - MONOLITHIC BELTLINE POWERED PANEL**

- Monolithic Beltline Powered Panel incorporates fabric modules with a power beltline raceway, within a solid steel frame.
- 6”H power beltline raceway, to accommodate electrical, is metal with knockouts on both side.
- A Chimney Panel is required to run electric and data from the base to belt.
- Beltline Connectors must be used in conjunction with beltline panels.
- Fabric covered modules are tackable and acoustical.
- Opposite sides of each panel may have a different fabric within the same grade at no upcharge.
- If different grades of fabric are used on one panel, the entire panel must be priced at highest grade.
- An aluminum low profile top cap is included.
- Stackability: Evolve panels can be increased in height in 6”H, 12”H, 18”H or 24”H increments. See Extension Module (pages 82-90) for part numbers.

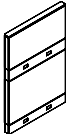
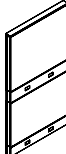
	DESCRIPTION	PRODUCT CODE	LIST PRICE		DIMENSIONS/INCHES		
			Gr1	Gr2	H	W	D
	Monolithic Beltline Powered Panel - 42” High 24” Fabric /6” Power Belt /6” Fabric	EVPBFAM4224	322	339	42	24	2 7/8
		EVPBFAM4230	381	401	42	30	2 7/8
		EVPBFAM4236	434	457	42	36	2 7/8
		EVPBFAM4242	489	516	42	42	2 7/8
		EVPBFAM4248	541	571	42	48	2 7/8
		EVPBFAM4254	593	627	42	54	2 7/8
	Monolithic Beltline Powered Panel - 54” High 24” Fabric /6” Power Belt /18” Fabric	EVPBFAM5424	387	410	54	24	2 7/8
		EVPBFAM5430	454	481	54	30	2 7/8
		EVPBFAM5436	512	544	54	36	2 7/8
		EVPBFAM5442	576	612	54	42	2 7/8
		EVPBFAM5448	633	676	54	48	2 7/8
		EVPBFAM5454	695	742	54	54	2 7/8
	Monolithic Beltline Powered Panel - 66” High 24” Fabric /6” Power Belt /30” Fabric	EVPBFAM6624	458	500	66	24	2 7/8
		EVPBFAM6630	535	583	66	30	2 7/8
		EVPBFAM6636	605	661	66	36	2 7/8
		EVPBFAM6642	682	747	66	42	2 7/8
		EVPBFAM6648	753	826	66	48	2 7/8
		EVPBFAM6654	826	907	66	54	2 7/8
		EVPBFAM6660	899	989	66	60	2 7/8



**EVPBLFAM - MONOLITHIC BELTLINE POWERED LIGHT PANEL**

- Monolithic Beltline Powered Light Panel incorporates fabric modules with a power beltline raceway within a solid steel frame
- 6”H power beltline raceway, to accommodate electrical, is metal with knockouts on both sides.
- There is no base raceway in Light Panels to accommodate electrical
- Light Beltline Panel Connectors must be used in conjunction with Light Beltline Panels.
- Fabric covered modules are tackable and acoustical.
- Opposite sides of each panel may have a different fabric within the same grade at no upcharge.
- If different grades of fabric are used on one panel, the entire panel must be priced at highest grade.
- An aluminum low profile top cap is included.
- Stackability: Evolve Light panels can be increased in height in 6”H, 12”H, 18”H or 24”H increments. See Extension Module (pages 82-90) for part numbers.

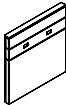
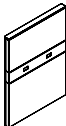
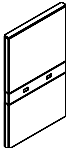
	DESCRIPTION	PRODUCT CODE	LIST PRICE		DIMENSIONS/INCHES		
			Gr1	Gr2	H	W	D
	Monolithic Beltline Powered Light Panel - 42” High	EVPBLFAM4224	306	322	42	24	2 7/8
		EVPBLFAM4230	362	381	42	30	2 7/8
	24” Fabric /6” Power Belt /6” Fabric	EVPBLFAM4236	412	436	42	36	2 7/8
		EVPBLFAM4242	464	490	42	42	2 7/8
		EVPBLFAM4248	514	543	42	48	2 7/8
		EVPBLFAM4254	564	598	42	54	2 7/8
		EVPBLFAM4260	614	651	42	60	2 7/8
	Monolithic Beltline Powered Light Panel - 54” High	EVPBLFAM5424	355	379	54	24	2 7/8
		EVPBLFAM5430	417	445	54	30	2 7/8
	24” Fabric /6” Power Belt /18” Fabric	EVPBLFAM5436	471	503	54	36	2 7/8
		EVPBLFAM5442	528	565	54	42	2 7/8
		EVPBLFAM5448	583	625	54	48	2 7/8
		EVPBLFAM5454	641	687	54	54	2 7/8
		EVPBLFAM5460	693	744	54	60	2 7/8
	Monolithic Beltline Powered Light Panel - 66” High	EVPBLFAM6624	426	468	66	24	2 7/8
		EVPBLFAM6630	496	545	66	30	2 7/8
	24” Fabric /6” Power Belt /30” Fabric	EVPBLFAM6636	562	619	66	36	2 7/8
		EVPBLFAM6642	633	698	66	42	2 7/8
		EVPBLFAM6648	699	774	66	48	2 7/8
		EVPBLFAM6654	768	849	66	54	2 7/8
		EVPBLFAM6660	835	925	66	60	2 7/8



**EVPBCFAM - MONOLITHIC BELTLINE POWERED CHIMNEY PANEL**

- Monolithic Chimney Beltline Powered Panel incorporates fabric modules with a power beltline raceway within a solid steel frame.
- A Chimney Panel is required to run electric and data from the base to belt.
- Separate electric harness required to go from base to belt (see EVE8CPCP).
- 6”H power beltline raceway, to accommodate electrical, is metal with knockouts on both sides.
- Beltline Connectors must be used in conjunction with beltline panels.
- Fabric covered modules are tackable and acoustical.
- Opposite sides of each panel may have a different fabric within the same grade at no upcharge.
- If different grades of fabric are used on one panel, the entire panel must be priced at highest grade.
- An aluminum low profile top cap is included.
- Stackability: Evolve panels can be increased in height in 6”H, 12”H, 18”H or 24”H increments. See Extension Module listings for part numbers

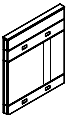
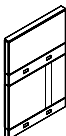
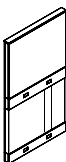
	DESCRIPTION	PRODUCT CODE	LIST PRICE		DIMENSIONS/INCHES		
			Gr1	Gr2	H	W	D
	Monolithic Beltline Powered Chimney Panel - 42” High 24” Fabric Chimney /6” Power Belt /6” Fabric	EVPBCFAM4236	488	512	42	36	2 7/8
		EVPBCFAM4242	543	570	42	42	2 7/8
	Monolithic Beltline Powered Chimney Panel - 54” High 24” Fabric Chimney /6” Power Belt /18” Fabric	EVPBCFAM5436	565	598	54	36	2 7/8
		EVPBCFAM5442	629	666	54	42	2 7/8
	Monolithic Beltline Powered Chimney Panel - 66” High 24” Fabric Chimney /6” Power Belt /30” Fabric	EVPBCFAM6636	658	715	66	36	2 7/8
		EVPBCFAM6642	735	800	66	42	2 7/8

**EVE8CPCP - CHIMNEY PANEL JUMPER CABLE KIT**



- Contains two (2) 17” flexible harnesses and one (1) “I” connector.
- Used to connect electric from the base to the beltline raceway in Beltline Powered Chimney panel.
- Must use in conjunction with base power distribution harness and beltline power distribution harness (sold separately)

	DESCRIPTION	PRODUCT CODE	LIST PRICE	DIMENSIONS/INCHES		
				H	W	D
	Chimney Panel Jumper Cable Kit	EVE8CPCP	229			

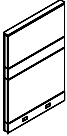

**EVPBFFAM - MONOLITHIC BELTLINE NON-POWERED PANEL**

- Monolithic Beltline Non-Powered Panel incorporates fabric modules within a solid steel frame.
- Electrical cannot pass through panel at the beltline level.
- Fabric covered modules are tackable and acoustical.
- Opposite sides of each panel may have a different fabric within the same grade at no upcharge.
- If different grades of fabric are used on one panel, the entire panel must be priced at highest grade.
- An aluminum low profile top cap is included.
- Stackability: Evolve panels can be increased in height in 6”H, 12”H, 18”H or 24”H increments. See Extension Module (pages 82-90) for part numbers.

	DESCRIPTION	PRODUCT CODE	LIST PRICE		DIMENSIONS/INCHES		
			Gr1	Gr2	H	W	D
	Monolithic Beltline Non-Powered Panel - 54” High	EVPBFFAM5424	387	413	54	24	2 7/8
	24” Fabric /6” Fabric /18” Fabric	EVPBFFAM5430	454	485	54	30	2 7/8
		EVPBFFAM5436	512	548	54	36	2 7/8
		EVPBFFAM5442	576	618	54	42	2 7/8
		EVPBFFAM5448	633	682	54	48	2 7/8
		EVPBFFAM5454	695	749	54	54	2 7/8
		EVPBFFAM5460	754	813	54	60	2 7/8
	Monolithic Beltline Non-Powered Panel - 66” High	EVPBFFAM6624	458	502	66	24	2 7/8
	24” Fabric /6” Fabric /30” Fabric	EVPBFFAM6630	535	586	66	30	2 7/8
		EVPBFFAM6636	605	665	66	36	2 7/8
		EVPBFFAM6642	682	752	66	42	2 7/8
		EVPBFFAM6648	753	831	66	48	2 7/8
		EVPBFFAM6654	826	913	66	54	2 7/8
		EVPBFFAM6660	899	995	66	60	2 7/8

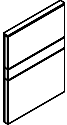
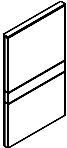

**EVPBLFFAM - MONOLITHIC BELTLINE NON-POWERED LIGHT PANEL**

- Monolithic Beltline Non-Powered Light Panel incorporates all fabric modules within a solid steel frame.
- There is no base raceway in Light Panels to accommodate electrical.
- Electrical cannot pass through panel at the beltline level.
- Fabric covered modules are tackable and acoustical.
- Opposite sides of each panel may have a different fabric within the same grade at no upcharge.
- If different grades of fabric are used on one panel, the entire panel must be priced at highest grade.
- An aluminum low profile top cap is included.
- Stackability: Evolve panels can be increased in height in 6”H, 12”H, 18”H or 24”H increments. See Extension Module (pages 82-90) for part numbers.

	DESCRIPTION	PRODUCT CODE	LIST PRICE		DIMENSIONS/INCHES		
			Gr1	Gr2	H	W	D
	Monolithic Beltline Non-Powered Light Panel - 54” High	EVPBLFFAM5424	355	382	54	24	2 7/8
	24” Fabric /6” Fabric /18” Fabric	EVPBLFFAM5430	419	451	54	30	2 7/8
		EVPBLFFAM5436	471	507	54	36	2 7/8
		EVPBLFFAM5442	528	571	54	42	2 7/8
		EVPBLFFAM5448	583	630	54	48	2 7/8
		EVPBLFFAM5454	641	693	54	54	2 7/8
		EVPBLFFAM5460	693	752	54	60	2 7/8
	Monolithic Beltline Non-Powered Light Panel - 66” High	EVPBLFFAM6624	426	470	66	24	2 7/8
	24” Fabric /6” Fabric /30” Fabric	EVPBLFFAM6630	496	548	66	30	2 7/8
		EVPBLFFAM6636	562	623	66	36	2 7/8
		EVPBLFFAM6642	633	705	66	42	2 7/8
		EVPBLFFAM6648	699	779	66	48	2 7/8
		EVPBLFFAM6654	768	855	66	54	2 7/8
		EVPBLFFAM6660	835	931	66	60	2 7/8

**EVPFA - SEGMENTED PANEL**

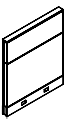
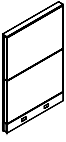
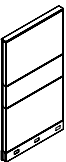
- Segmented Panel incorporates fabric modules within a solid steel frame.
- Fabric covered modules are tackable and acoustical.
- Opposite sides of each panel may have a different fabric within the same grade at no upcharge.
- If different grades of fabric are used on one panel, the entire panel must be priced at highest grade.
- An aluminum low profile top cap is included.
- Stackability: Evolve panels can be increased in height in 6”H, 12”H, 18”H or 24”H increments. See Extension Module (pages 82-90) for part numbers.

	DESCRIPTION	PRODUCT CODE	LIST PRICE		DIMENSIONS/INCHES		
			Gr1	Gr2	H	W	D
	Segmented Panel - 30" High	EVPPFA3018	237	246	30	18	2 7/8
		EVPPFA3024	246	260	30	24	2 7/8
		EVPPFA3030	275	289	30	30	2 7/8
		EVPPFA3036	298	315	30	36	2 7/8
		EVPPFA3042	318	340	30	42	2 7/8
		EVPPFA3048	351	375	30	48	2 7/8
		EVPPFA3054	380	406	30	54	2 7/8
		EVPPFA3060	408	437	30	60	2 7/8
	Segmented Panel - 42" High	EVPPFA4218	262	277	42	18	2 7/8
		EVPPFA4224	278	298	42	24	2 7/8
		EVPPFA4230	323	347	42	30	2 7/8
		EVPPFA4236	347	374	42	36	2 7/8
		EVPPFA4242	396	426	42	42	2 7/8
		EVPPFA4248	426	462	42	48	2 7/8
		EVPPFA4254	472	512	42	54	2 7/8
		EVPPFA4260	518	562	42	60	2 7/8
	Segmented Panel - 54" High	EVPPFA5418	282	303	54	18	2 7/8
		EVPPFA5424	308	333	54	24	2 7/8
		EVPPFA5430	352	384	54	30	2 7/8
		EVPPFA5436	393	430	54	36	2 7/8
		EVPPFA5442	445	487	54	42	2 7/8
		EVPPFA5448	495	543	54	48	2 7/8
		EVPPFA5454	537	588	54	54	2 7/8
		EVPPFA5460	577	633	54	60	2 7/8
	Segmented Panel - 66" High	EVPPFA6618	355	381	66	18	2 7/8
		EVPPFA6624	382	415	66	24	2 7/8
		EVPPFA6630	424	462	66	30	2 7/8
		EVPPFA6636	497	544	66	36	2 7/8
		EVPPFA6642	560	612	66	42	2 7/8
		EVPPFA6648	602	661	66	48	2 7/8
		EVPPFA6654	653	719	66	54	2 7/8
		EVPPFA6660	708	780	66	60	2 7/8
	Segmented Panel - 66" High	EVPPFA6618S	355	381	66	18	2 7/8
		EVPPFA6624S	382	415	66	24	2 7/8
		EVPPFA6630S	424	462	66	30	2 7/8
		EVPPFA6636S	497	544	66	36	2 7/8
		EVPPFA6642S	560	612	66	42	2 7/8
		EVPPFA6648S	602	661	66	48	2 7/8
		EVPPFA6654S	653	719	66	54	2 7/8
		EVPPFA6660S	708	780	66	60	2 7/8



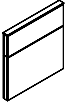
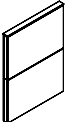
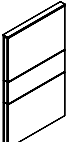
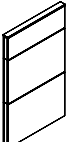

**EVPLFA - SEGMENTED LIGHT PANEL**

- Segmented Light Panel incorporates fabric modules within a solid steel frame.
- There is no base raceway in Light Panels to accommodate electrical.
- Light Panel Connectors must be used in conjunction with Light Panels.
- Fabric covered modules are tackable and acoustical.
- Opposite sides of each panel may have a different fabric within the same grade at no upcharge.
- If different grades of fabric are used on one panel, the entire panel must be priced at highest grade.
- An aluminum low profile top cap is included.
- Stackability: Evolve Light panels can be increased in height in 6”H, 12”H, 18”H or 24”H increments. See Extension Module (pages 82-90) for part numbers.

	DESCRIPTION	PRODUCT CODE	LIST PRICE		DIMENSIONS/INCHES		
			Gr1	Gr2	H	W	D
	Segmented Light Panel - 30" High	EVPLFA3018	225	235	30	18	2 7/8
		EVPLFA3024	235	246	30	24	2 7/8
		EVPLFA3030	261	276	30	30	2 7/8
		EVPLFA3036	282	299	30	36	2 7/8
		EVPLFA3042	302	322	30	42	2 7/8
		EVPLFA3048	334	357	30	48	2 7/8
		EVPLFA3054	361	385	30	54	2 7/8
	Segmented Light Panel - 42" High	EVPLFA4218	249	263	42	18	2 7/8
		EVPLFA4224	264	282	42	24	2 7/8
		EVPLFA4230	307	330	42	30	2 7/8
		EVPLFA4236	330	355	42	36	2 7/8
		EVPLFA4242	376	405	42	42	2 7/8
		EVPLFA4248	405	440	42	48	2 7/8
		EVPLFA4254	448	485	42	54	2 7/8
	Segmented Light Panel - 54" High	EVPLFA5418	268	287	54	18	2 7/8
		EVPLFA5424	294	317	54	24	2 7/8
		EVPLFA5430	336	365	54	30	2 7/8
		EVPLFA5436	374	408	54	36	2 7/8
		EVPLFA5442	422	462	54	42	2 7/8
		EVPLFA5448	471	516	54	48	2 7/8
		EVPLFA5454	510	559	54	54	2 7/8
	Segmented Light Panel - 66" High	EVPLFA6618	339	362	66	18	2 7/8
		EVPLFA6624	362	394	66	24	2 7/8
		EVPLFA6630	403	440	66	30	2 7/8
		EVPLFA6636	473	517	66	36	2 7/8
		EVPLFA6642	533	582	66	42	2 7/8
		EVPLFA6648	571	627	66	48	2 7/8
		EVPLFA6654	621	684	66	54	2 7/8
	Segmented Light Panel - 66" High	EVPLFA6618S	339	362	66	18	2 7/8
		EVPLFA6624S	362	394	66	24	2 7/8
		EVPLFA6630S	403	440	66	30	2 7/8
		EVPLFA6636S	473	517	66	36	2 7/8
		EVPLFA6642S	533	582	66	42	2 7/8
		EVPLFA6648S	571	627	66	48	2 7/8
		EVPLFA6654S	621	684	66	54	2 7/8
EVPLFA6660S	672	741	66	60	2 7/8		

**EVFPF - SEGMENTED PREMIUM PANEL**

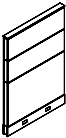
- Segmented Premium Panel incorporates fabric modules within a solid steel frame.
- Segmented Premium panels incorporate 12" H acoustic modules above 24" base module , plus 6" H base raceway.
- Fabric covered modules are tackable and acoustical.
- Opposite sides of each panel may have a different fabric within the same grade at no upcharge.
- If different grades of fabric are used on one panel, the entire panel must be priced at highest grade.
- An aluminum low profile top cap is included.
- Stackability: Evolve panels can be increased in height in 6"H, 12"H, 18"H or 24"H increments. See Extension Module (pages 82-90) for part numbers.

	DESCRIPTION	PRODUCT CODE	LIST PRICE		DIMENSIONS/INCHES		
			Gr1	Gr2	H	W	D
	Segmented Premium Panel - 54" High	EVFPF5418	331	351	54	18	2 7/8
		EVFPF5424	351	377	54	24	2 7/8
		EVFPF5430	388	418	54	30	2 7/8
		EVFPF5436	457	493	54	36	2 7/8
		EVFPF5442	516	558	54	42	2 7/8
		EVFPF5448	552	599	54	48	2 7/8
		EVFPF5454	586	640	54	54	2 7/8
		EVFPF5460	620	678	54	60	2 7/8
	Segmented Premium Panel - 66" High	EVFPF6618	416	441	66	18	2 7/8
		EVFPF6624	434	466	66	24	2 7/8
		EVFPF6630	472	512	66	30	2 7/8
		EVFPF6636	500	547	66	36	2 7/8
		EVFPF6642	596	649	66	42	2 7/8
		EVFPF6648	652	712	66	48	2 7/8
		EVFPF6654	695	760	66	54	2 7/8
		EVFPF6660	739	812	66	60	2 7/8

**EVPLFP - SEGMENTED LIGHT PANEL - PREMIUM**

- Segmented Premium Light Panel incorporates fabric modules within a solid steel frame.
- Segmented Premium panels incorporate 12" H acoustic modules above 24" base module , plus 6" H open base.
- There is no base raceway in Light Panels to accommodate electrical.
- Light Panel Connectors must be used in conjunction with Light Panels.
- Fabric covered modules are tackable and acoustical.
- Opposite sides of each panel may have a different fabric within the same grade at no upcharge.
- If different grades of fabric are used on one panel, the entire panel must be priced at highest grade.
- An aluminum low profile top cap is included.
- Stackability: Evolve Light panels can be increased in height in 6"H, 12"H, 18"H or 24"H increments. See Extension Module (pages 82-90) for part numbers.

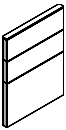
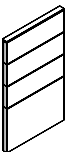
	DESCRIPTION	PRODUCT CODE	LIST PRICE		DIMENSIONS/INCHES		
			Gr1	Gr2	H	W	D
	Segmented Premium Light Panel - Premium - 54" High	EVPLFP5418	315	334	54	18	2 7/8
		EVPLFP5424	334	359	54	24	2 7/8
		EVPLFP5430	369	398	54	30	2 7/8
		EVPLFP5436	435	469	54	36	2 7/8
		EVPLFP5442	490	530	54	42	2 7/8
		EVPLFP5448	524	569	54	48	2 7/8
		EVPLFP5454	557	607	54	54	2 7/8
		EVPLFP5460	588	645	54	60	2 7/8
	Segmented Premium Light Panel - Premium - 66" High	EVPLFP6618	396	419	66	18	2 7/8
		EVPLFP6624	412	442	66	24	2 7/8
		EVPLFP6630	448	485	66	30	2 7/8
		EVPLFP6636	475	520	66	36	2 7/8
		EVPLFP6642	565	617	66	42	2 7/8
		EVPLFP6648	620	676	66	48	2 7/8
		EVPLFP6654	661	722	66	54	2 7/8
		EVPLFP6660	701	771	66	60	21/4



**EVPBFA - SEGMENTED BELTLINE POWERED PANEL**

- Segmented Beltline Powered Panel incorporates fabric modules with a power beltline raceway, within a solid steel frame.
- A Chimney Panel is required to run electric and data from the base to belt.
- 6”H power beltline raceway, to accommodate electrical, is metal with knockouts on both sides.
- Beltline connectors must be used in conjunction with beltline panels.
- Fabric covered modules are tackable and acoustical.
- Opposite sides of each panel may have a different fabric within the same grade at no upcharge.
- If different grades of fabric are used on one panel, the entire panel must be priced at highest grade.
- An aluminum low profile top cap is included.
- Stackability: Evolve panels can be increased in height in 6”H, 12”H, 18”H or 24”H increments. See Extension Module (pages 82-90) for part numbers.

	DESCRIPTION	PRODUCT CODE	LIST PRICE		DIMENSIONS/INCHES		
			Gr1	Gr2	H	W	D
	Segmented Beltline Powered Panel - 54” High 24” Fabric /6” Power /6” Fabric /12” Fabric	EVPBFA5424	386	409	54	24	2 7/8
		EVPBFA5430	452	479	54	30	2 7/8
		EVPBFA5436	521	554	54	36	2 7/8
		EVPBFA5442	585	622	54	42	2 7/8
		EVPBFA5448	640	682	54	48	2 7/8
		EVPBFA5454	701	749	54	54	2 7/8
		EVPBFA5460	764	816	54	60	2 7/8
	Segmented Beltline Powered Panel - 66” High 24” Fabric /6” Power /6” Fabric /24” Fabric	EVPBFA6624	462	492	66	24	2 7/8
		EVPBFA6630	541	576	66	30	2 7/8
		EVPBFA6636	614	656	66	36	2 7/8
		EVPBFA6642	691	739	66	42	2 7/8
		EVPBFA6648	763	817	66	48	2 7/8
		EVPBFA6654	838	898	66	54	2 7/8
		EVPBFA6660	912	977	66	60	2 7/8

**EVPBLFA - SEGMENTED BELTLINE POWERED LIGHT PANEL**

- Segmented Beltline Powered Light Panel incorporates fabric modules with a power beltline raceway, within a solid steel frame.
- There is no base raceway in Light Panels to accommodate electrical.
- 6”H power beltline raceway, to accommodate electrical, is metal with knockouts on both sides.
- Beltline Light Panel Connectors must be used in conjunction with Beltline Light Panels.
- Fabric covered modules are tackable and acoustical.
- Opposite sides of each panel may have a different fabric within the same grade at no upcharge.
- If different grades of fabric are used on one panel, the entire panel must be priced at highest grade.
- An aluminum low profile top cap is included.
- Stackability: Evolve Light panels can be increased in height in 6”H, 12”H, 18”H or 24”H increments. See Extension Module (pages 82-90) for part numbers.

	DESCRIPTION	PRODUCT CODE	LIST PRICE		DIMENSIONS/INCHES		
			Gr1	Gr2	H	W	D
	Segmented Beltline Powered Light Panel - 54” High 24” Fabric /6” Power /6” Fabric /12” Fabric	EVPBLFA5424	354	377	54	24	2 7/8
		EVPBLFA5430	415	442	54	30	2 7/8
		EVPBLFA5436	480	513	54	36	2 7/8
		EVPBLFA5442	539	576	54	42	2 7/8
		EVPBLFA5448	588	630	54	48	2 7/8
		EVPBLFA5454	646	692	54	54	2 7/8
		EVPBLFA5460	705	755	54	60	2 7/8
	Segmented Beltline Powered Light Panel - 66” High 24” Fabric /6” Power /6” Fabric /24” Fabric	EVPBLFA6624	426	455	66	24	2 7/8
		EVPBLFA6630	497	533	66	30	2 7/8
		EVPBLFA6636	565	608	66	36	2 7/8
		EVPBLFA6642	636	684	66	42	2 7/8
		EVPBLFA6648	701	755	66	48	2 7/8
		EVPBLFA6654	771	830	66	54	2 7/8
		EVPBLFA6660	839	905	66	60	2 7/8

**EVPBCFA - SEGMENTED BELTLINE POWERED CHIMNEY PANEL**

- Segmented Chimney Beltline Powered Panel incorporates fabric modules with a power beltline raceway, within a solid steel frame.
- A Chimney Panel is required to run electric and data from the base to belt.
- Separate electric harness required to go from base to belt (see EVE8CPCP).
- 6”H power beltline raceway, to accommodate electrical, is metal with knockouts on both sides.
- Beltline Connectors must be used in conjunction with beltline panels.
- Fabric covered modules are tackable and acoustical.
- Opposite sides of each panel may have a different fabric within the same grade at no upcharge.
- If different grades of fabric are used on one panel, the entire panel must be priced at highest grade.
- An aluminum low profile top cap is included.
- Stackability: Evolve panels can be increased in height in 6”H, 12”H, 18”H or 24”H increments. See Extension Module (pages 82-90) for part numbers.

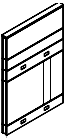
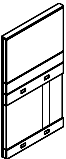
	DESCRIPTION	PRODUCT CODE	LIST PRICE		DIMENSIONS/INCHES		
			Gr1	Gr2	H	W	D
	Segmented Beltline Powered Chimney Panel - 54” High	EVPBCFA5436	576	608	54	36	2 7/8
	24” Fabric Chimney /6” Power / 6” Fabric /12” Fabric	EVPBCFA5442	640	676	54	42	2 7/8
	Segmented Beltline Powered Chimney Panel - 66” High	EVPBCFA6636	668	711	66	36	2 7/8
	24” Fabric Chimney /6” Power / 6” Fabric /24” Fabric	EVPBCFA6642	745	793	66	42	2 7/8

**EVE8CPCP - CHIMNEY PANEL JUMPER CABLE KIT**

- Contains two (2) 17” flexible harnesses and one (1) “I” connector.
- Used to connect electric from the base to the beltline raceway in Beltline Powered Chimney panel.
- Must use in conjunction with base power distribution harness and beltline power distribution harness (sold separately)

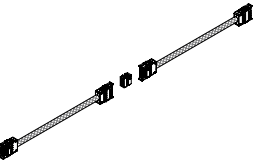
	DESCRIPTION	PRODUCT CODE	LIST PRICE	DIMENSIONS/INCHES		
				H	W	D
	Chimney Panel Jumper Cable Kit	EVE8CPCP	229			



**EVPBFFA - SEGMENTED BELTLINE NON-POWERED PANEL**

- Double Beltline Non-Powered Panel incorporates all fabric modules within a solid steel frame.
- Electrical cannot pass through panel at the beltline level.
- Fabric covered modules are tackable and acoustical.
- Opposite sides of each panel may have a different fabric within the same grade at no upcharge.
- If different grades of fabric are used on one panel, the entire panel must be priced at highest grade.
- An aluminum low profile top cap is included.
- Stackability: Evolve panels can be increased in height in 6”H, 12”H, 18”H or 24”H increments. See Extension Module (pages 82-90) for part numbers.

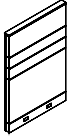
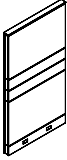
	DESCRIPTION	PRODUCT CODE	LIST PRICE		DIMENSIONS/INCHES		
			Gr1	Gr2	H	W	D
	Segmented Beltline Non-Powered Panel - 54” High	EVPBFFA5424	372	393	54	24	2 7/8
		EVPBFFA5430	408	439	54	30	2 7/8
	24” Fabric /6” Fabric /6” Fabric /12” Fabric	EVPBFFA5436	480	517	54	36	2 7/8
		EVPBFFA5442	541	583	54	42	2 7/8
		EVPBFFA5448	580	627	54	48	2 7/8
		EVPBFFA5454	613	666	54	54	2 7/8
		EVPBFFA5460	643	700	54	60	2 7/8
	Segmented Beltline Non-Powered Panel - 66” High	EVPBFFA6624	404	436	66	24	2 7/8
		EVPBFFA6630	474	513	66	30	2 7/8
	24” Fabric /6” Fabric /6” Fabric /24” Fabric	EVPBFFA6636	548	593	66	36	2 7/8
		EVPBFFA6642	615	668	66	42	2 7/8
		EVPBFFA6648	673	732	66	48	2 7/8
		EVPBFFA6654	740	805	66	54	2 7/8
		EVPBFFA6660	806	880	66	60	2 7/8

**EVPBLFFA - SEGMENTED BELTLINE NON-POWERED LIGHT PANEL**

- Double Beltline Non-Powered Panel incorporates all fabric modules within a solid steel frame.
- Electrical cannot pass through panel at the beltline level.
- There is no base raceway in Light Panels to accommodate electrical
- Fabric covered modules are tackable and acoustical.
- Opposite sides of each panel may have a different fabric within the same grade at no upcharge.
- If different grades of fabric are used on one panel, the entire panel must be priced at highest grade.
- An aluminum low profile top cap is included.
- Stackability: Evolve panels can be increased in height in 6”H, 12”H, 18”H or 24”H increments.
- See Extension Module (pages 82-90) for part numbers.

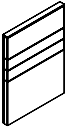
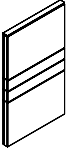
	DESCRIPTION	PRODUCT CODE	LIST PRICE		DIMENSIONS/INCHES		
			Gr1	Gr2	H	W	D
	Segmented Beltline Non-Powered Light Panel - 54” High	EVPBLFFA5424	307	333	54	24	2 7/8
		EVPBLFFA5430	362	392	54	30	2 7/8
	24” Fabric /6” Fabric /6” Fabric /12” Fabric	EVPBLFFA5436	411	448	54	36	2 7/8
		EVPBLFFA5442	460	503	54	42	2 7/8
		EVPBLFFA5448	510	557	54	48	2 7/8
		EVPBLFFA5454	582	634	54	54	2 7/8
		EVPBLFFA5460	610	668	54	60	2 7/8
	Segmented Beltline Non-Powered Light Panel - 66” High	EVPBLFFA6624	382	414	66	24	2 7/8
		EVPBLFFA6630	424	462	66	30	2 7/8
	24” Fabric /6” Fabric /6” Fabric /24” Fabric	EVPBLFFA6636	497	543	66	36	2 7/8
		EVPBLFFA6642	560	613	66	42	2 7/8
		EVPBLFFA6648	602	661	66	48	2 7/8
		EVPBLFFA6654	653	719	66	54	2 7/8
		EVPBLFFA6660	708	780	66	60	2 7/8



**EVPMGU - MONOLITHIC 12”H GLAZED PANEL - TEMPERED GLASS**

- Monolithic 12”H Glazed Panel incorporates a lower fabric module with a 12”H top position glazed module, into a solid steel frame.
- Fabric covered modules are tackable and acoustical.
- Opposite sides of each panel may have a different fabric within the same grade at no upcharge.
- If different grades of fabric are used on one panel, the entire panel must be priced at highest grade.
- An aluminum low profile top cap is included.
- Stackability: Evolve panels can be increased in height in 6”H, 12”H, 18”H or 24”H increments. See Extension Module (pages 82-90) for part numbers.
- Standard in clear (CLR) or smoked glass (SMK) as an option.
- Frosted glass (FRST) 20% upcharge.

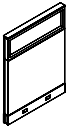
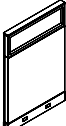
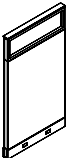
	DESCRIPTION	PRODUCT CODE	LIST PRICE		DIMENSIONS/INCHES		
			Gr1	Gr2	H	W	D
	Monolithic 12”H Glazed Panel - Tempered Glass - 48” High	EVPMGU4818	362	382	48	18	2 7/8
		EVPMGU4824	423	450	48	24	2 7/8
		EVPMGU4830	491	524	48	30	2 7/8
		EVPMGU4836	562	602	48	36	2 7/8
		EVPMGU4842	624	667	48	42	2 7/8
		EVPMGU4848	678	729	48	48	2 7/8
		EVPMGU4854	753	804	48	54	2 7/8
		EVPMGU4860	826	888	48	60	2 7/8
	Monolithic 12”H Glazed Panel - Tempered Glass - 54” High	EVPMGU5418	373	396	54	18	2 7/8
		EVPMGU5424	434	460	54	24	2 7/8
		EVPMGU5430	495	530	54	30	2 7/8
		EVPMGU5436	552	588	54	36	2 7/8
		EVPMGU5442	613	657	54	42	2 7/8
		EVPMGU5448	678	729	54	48	2 7/8
		EVPMGU5454	742	797	54	54	2 7/8
		EVPMGU5460	805	867	54	60	2 7/8
	Monolithic 12”H Glazed Panel - Tempered Glass - 66” High	EVPMGU6618	398	419	66	18	2 7/8
		EVPMGU6624	477	506	66	24	2 7/8
		EVPMGU6630	544	579	66	30	2 7/8
		EVPMGU6636	609	648	66	36	2 7/8
		EVPMGU6642	677	721	66	42	2 7/8
		EVPMGU6648	748	798	66	48	2 7/8
		EVPMGU6654	818	872	66	54	2 7/8
		EVPMGU6660	890	950	66	60	2 7/8



**EVPLMGU - MONOLITHIC 12”H GLAZED LIGHT PANEL - TEMPERED GLASS**

- Monolithic 12”H Glazed Light Panel incorporates a lower fabric module with a 12”H top position glazed module, into a solid steel frame.
- There is no base raceway in Light Panels to accommodate electrical.
- Light Panel Connectors must be used in conjunction with Light Panels.
- Fabric covered modules are tackable and acoustical.
- Opposite sides of each panel may have a different fabric within the same grade at no upcharge.
- If different grades of fabric are used on one panel, the entire panel must be priced at highest grade.
- An aluminum low profile top cap is included.
- Stackability: Evolve panels can be increased in height in 6”H, 12”H, 18”H or 24”H increments. See Extension Module (pages 82-90) for part numbers.
- Standard in clear (CLR) or smoked glass (SMK) as an option.
- Frosted glass (FRST) 20% upcharge.

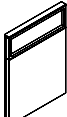
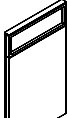
	DESCRIPTION	PRODUCT CODE	LIST PRICE		DIMENSIONS/INCHES		
			Gr1	Gr2	H	W	D
	Monolithic 12”H Glazed Light Panel - Tempered Glass - 48” High	EVPLMGU4818	353	374	48	18	2 7/8
		EVPLMGU4824	414	441	48	24	2 7/8
		EVPLMGU4830	481	514	48	30	2 7/8
		EVPLMGU4836	552	589	48	36	2 7/8
		EVPLMGU4842	611	654	48	42	2 7/8
		EVPLMGU4848	664	715	48	48	2 7/8
		EVPLMGU4854	737	788	48	54	2 7/8
		EVPLMGU4860	810	870	48	60	2 7/8
	Monolithic 12”H Glazed Light Panel - Tempered Glass - 54” High	EVPLMGU5418	366	388	54	18	2 7/8
		EVPLMGU5424	425	451	54	24	2 7/8
		EVPLMGU5430	485	519	54	30	2 7/8
		EVPLMGU5436	541	577	54	36	2 7/8
		EVPLMGU5442	602	645	54	42	2 7/8
		EVPLMGU5448	664	715	54	48	2 7/8
		EVPLMGU5454	727	781	54	54	2 7/8
		EVPLMGU5460	790	850	54	60	2 7/8
	Monolithic 12”H Glazed Light Panel - Tempered Glass - 66” High	EVPLMGU6618	390	411	66	18	2 7/8
		EVPLMGU6624	468	496	66	24	2 7/8
		EVPLMGU6630	534	567	66	30	2 7/8
		EVPLMGU6636	597	634	66	36	2 7/8
		EVPLMGU6642	663	708	66	42	2 7/8
		EVPLMGU6648	732	782	66	48	2 7/8
		EVPLMGU6654	801	856	66	54	2 7/8
		EVPLMGU6660	872	930	66	60	2 7/8

**EVPPFGTU - FABRIC 12”H GLAZED PANEL - TEMPERED GLASS**

- Segmented 12”H Glazed Panel incorporates a lower fabric module with a 12”H top position glazed module, into a solid steel frame.
- Panels incorporate 12”H acoustic modules above 30”H base section with a 12”H glazed module at the top.
- Fabric covered modules are tackable and acoustical.
- Opposite sides of each panel may have a different fabric within the same grade at no upcharge.
- If different grades of fabric are used on one panel, the entire panel must be priced at highest grade.
- An aluminum low profile top cap is included.
- Stackability: Evolve panels can be increased in height in 6”H, 12”H, 18”H or 24”H increments. See Extension Module (pages 82-90) for part numbers.
- Standard in clear (CLR) or smoked glass (SMK) as an option.
- Frosted glass (FRST) 20% upcharge.

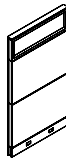
	DESCRIPTION	PRODUCT CODE	LIST PRICE		DIMENSIONS/INCHES		
			Gr1	Gr2	H	W	D
	Fabric 12” Glazed Panel - Tempered Glass 66” High	EVPPFGTU6618	446	467	66	18	2 7/8
		EVPPFGTU6624	521	548	66	24	2 7/8
		EVPPFGTU6630	595	626	66	30	2 7/8
		EVPPFGTU6636	667	705	66	36	2 7/8
		EVPPFGTU6642	752	793	66	42	2 7/8
		EVPPFGTU6648	816	863	66	48	2 7/8
		EVPPFGTU6654	912	964	66	54	2 7/8
		EVPPFGTU6660	1006	1063	66	60	2 7/8

**EVPLFGTU - FABRIC 12”H GLAZED LIGHT PANEL**

- Segmented 12”H Glazed Light Panel incorporates a lower fabric module with a 12”H top position glazed module, into a solid steel frame.
- Panels incorporate 12”H acoustic modules above 30”H base section with a 12”H glazed module at the top.
- There is no base raceway in Light Panels to accommodate electrical.
- Light Panel Connectors must be used in conjunction with Light Panels.
- Opposite sides of each panel may have a different fabric within the same grade at no upcharge.
- If different grades of fabric are used on one panel, the entire panel must be priced at highest grade.
- An aluminum low profile top cap is included.
- Stackability: Evolve panels can be increased in height in 6”H, 12”H, 18”H or 24”H increments.
- See Extension Module (pages 82-90) for part numbers.
- Standard in clear (CLR) or smoked glass (SMK) as an option.
- Frosted glass (FRST) 20% upcharge.

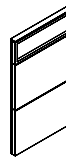
	DESCRIPTION	PRODUCT CODE	LIST PRICE		DIMENSIONS/INCHES		
			Gr1	Gr2	H	W	D
	Fabric 12”H Glazed Light Panel - 66” High	EVPLFGTU6618	437	456	66	18	2 7/8
		EVPLFGTU6624	511	538	66	24	2 7/8
		EVPLFGTU6630	583	613	66	30	2 7/8
		EVPLFGTU6636	654	690	66	36	2 7/8
		EVPLFGTU6642	736	777	66	42	2 7/8
		EVPLFGTU6648	799	846	66	48	2 7/8
		EVPLFGTU6654	893	945	66	54	2 7/8
		EVPLFGTU6660	986	1041	66	60	2 7/8



**EVFPFGTU - SEGMENTED 12”H GLAZED PANEL - PREMIUM - TEMPERED GLASS**

- Segmented 12”H Glazed Premium Panel incorporates a lower fabric module with a 12”H top position glazed module, into a solid steel frame.
- Premium panels incorporate 12”H acoustic modules above 30”H base section with a 12”H glazed module at the top.
- Fabric covered modules are tackable and acoustical.
- Opposite sides of each panel may have a different fabric within the same grade at no upcharge.
- If different grades of fabric are used on one panel, the entire panel must be priced at highest grade.
- An aluminum low profile top cap is included.
- Stackability: Evolve panels can be increased in height in 6”H, 12”H, 18”H or 24”H increments. See Extension Module (pages 82-90) for part numbers.
- Standard in clear (CLR) or smoked glass (SMK) as an option.
- Frosted glass (FRST) 20% upcharge.

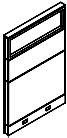
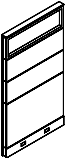
	DESCRIPTION	PRODUCT CODE	LIST PRICE		DIMENSIONS/INCHES		
			Gr1	Gr2	H	W	D
	Segmented 12”H Glazed Premium Panel - Tempered Glass - 54” High	EVFPFGTU5418	411	425	54	18	2 7/8
		EVFPFGTU5424	482	502	54	24	2 7/8
		EVFPFGTU5430	545	570	54	30	2 7/8
		EVFPFGTU5436	613	642	54	36	2 7/8
		EVFPFGTU5442	689	721	54	42	2 7/8
		EVFPFGTU5448	748	783	54	48	2 7/8
		EVFPFGTU5454	838	878	54	54	2 7/8
		EVFPFGTU5460	927	971	54	60	2 7/8
	Segmented 12”H Glazed Premium Panel - Tempered Glass - 66” High	EVFPFGTU6618	504	522	66	18	2 7/8
		EVFPFGTU6624	590	618	66	24	2 7/8
		EVFPFGTU6630	672	701	66	30	2 7/8
		EVFPFGTU6636	756	793	66	36	2 7/8
		EVFPFGTU6642	853	895	66	42	2 7/8
		EVFPFGTU6648	923	970	66	48	2 7/8
		EVFPFGTU6654	1032	1085	66	54	2 7/8
		EVFPFGTU6660	1147	1206	66	60	2 7/8

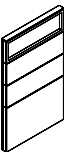

**EVPLFPGTU - SEGMENTED 12”H GLAZED PREMIUM LIGHT PANEL – TEMPERED GLASS**

- Segmented 12”H Glazed Premium Light Panel incorporates a lower fabric module with a 12”H top position glazed module, into a solid steel frame.
- Premium panels incorporate 12”H acoustic modules above 30”H base section with a 12”H glazed module at the top.
- There is no base raceway in Light Panels to accommodate electrical.
- Light Panel Connectors must be used in conjunction with Light Panels.
- Opposite sides of each panel may have a different fabric within the same grade at no upcharge.
- If different grades of fabric are used on one panel, the entire panel must be priced at highest grade.
- An aluminum low profile top cap is included.
- Stackability: Evolve panels can be increased in height in 6”H, 12”H, 18”H or 24”H increments.
- See Extension Module (pages 82-90) for part numbers.
- Standard in clear (CLR) or smoked glass (SMK) as an option.
- Frosted glass (FRST) 20% upcharge.

	DESCRIPTION	PRODUCT CODE	LIST PRICE		DIMENSIONS/INCHES		
			Gr1	Gr2	H	W	D
	Segmented 12”H Glazed Premium Panel - Premium - Tempered Glass - 54” High	EVPLFPGTU5418	403	416	54	18	2 7/8
		EVPLFPGTU5424	473	492	54	24	2 7/8
		EVPLFPGTU5430	535	558	54	30	2 7/8
		EVPLFPGTU5436	602	628	54	36	2 7/8
		EVPLFPGTU5442	675	708	54	42	2 7/8
		EVPLFPGTU5448	732	768	54	48	2 7/8
		EVPLFPGTU5454	822	860	54	54	2 7/8
		EVPLFPGTU5460	908	952	54	60	2 7/8
	Segmented 12”H Glazed Premium Panel - Premium - Tempered Glass - 66” High	EVPLFPGTU6618	494	512	66	18	2 7/8
		EVPLFPGTU6624	579	606	66	24	2 7/8
		EVPLFPGTU6630	658	688	66	30	2 7/8
		EVPLFPGTU6636	741	777	66	36	2 7/8
		EVPLFPGTU6642	836	878	66	42	2 7/8
		EVPLFPGTU6648	904	951	66	48	2 7/8
		EVPLFPGTU6654	1011	1063	66	54	2 7/8
		EVPLFPGTU6660	1125	1182	66	60	2 7/8

**EVPPFGT - PARTLY GLAZED PANEL - TEMPERED GLASS**

- Partly Glazed Panel incorporates a lower fabric module with a 12”H or 24”H top position glazed module, into a solid steel frame.
- Opposite sides of each panel may have a different fabric within the same grade at no upcharge.
- If different grades of fabric are used on one panel, the entire panel must be priced at highest grade.
- An aluminum low profile top cap is included.
- Stackability: Evolve panels can be increased in height in 6”H, 12”H, 18”H or 24”H increments. See Extension Module (pages 82-90) for part numbers.
- Standard in clear (CLR) or smoked glass (SMK) as an option.
- Frosted glass (FRST) 20% upcharge.

	DESCRIPTION	PRODUCT CODE	LIST PRICE		DIMENSIONS/INCHES		
			Gr1	Gr2	H	W	D
	Partly Glazed Panel - Tempered Glass - 42" High	EVPPFGT4218	316	327	42	18	2 7/8
		EVPPFGT4224	373	386	42	24	2 7/8
		EVPPFGT4230	422	438	42	30	2 7/8
		EVPPFGT4236	471	490	42	36	2 7/8
		EVPPFGT4242	525	547	42	42	2 7/8
		EVPPFGT4248	574	597	42	48	2 7/8
		EVPPFGT4254	642	667	42	54	2 7/8
		EVPPFGT4260	709	737	42	60	2 7/8
	Partly Glazed Panel - Tempered Glass - 54" High	EVPPFGT5418	349	361	54	18	2 7/8
		EVPPFGT5424	406	419	54	24	2 7/8
		EVPPFGT5430	471	487	54	30	2 7/8
		EVPPFGT5436	535	554	54	36	2 7/8
		EVPPFGT5442	599	620	54	42	2 7/8
		EVPPFGT5448	652	676	54	48	2 7/8
		EVPPFGT5454	757	783	54	54	2 7/8
		EVPPFGT5460	859	890	54	60	2 7/8
	Partly Glazed Panel - Tempered Glass - 66" High	EVPPFGT6618	444	459	66	18	2 7/8
		EVPPFGT6624	515	536	66	24	2 7/8
		EVPPFGT6630	595	619	66	30	2 7/8
		EVPPFGT6636	677	705	66	36	2 7/8
		EVPPFGT6642	762	795	66	42	2 7/8
		EVPPFGT6648	827	863	66	48	2 7/8
		EVPPFGT6654	952	992	66	54	2 7/8
		EVPPFGT6660	1078	1122	66	60	2 7/8



**EVPLFGT - PARTLY GLAZED LIGHT PANEL - TEMPERED GLASS**

- Partly Glazed Light Panel incorporates a lower fabric module with a 12”H or 24”H top position glazed module, into a solid steel frame.
- There is no base raceway in Light Panels to accommodate electrical.
- Light Panel Connectors must be used in conjunction with Light Panels.
- Opposite sides of each panel may have a different fabric within the same grade at no upcharge.
- If different grades of fabric are used on one panel, the entire panel must be priced at highest grade.
- An aluminum low profile top cap is included.
- Stackability: Evolve panels can be increased in height in 6”H, 12”H, 18”H or 24”H increments. See Extension Module (pages 82-90) for part numbers.
- Standard in clear (CLR) or smoked glass (SMK) as an option.
- Frosted glass (FRST) 20% upcharge.

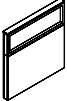
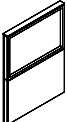
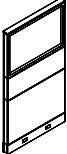
	DESCRIPTION	PRODUCT CODE	LIST PRICE		DIMENSIONS/INCHES		
			Gr1	Gr2	H	W	D
	Partly Glazed Light Panel - Tempered Glass - 42” High	EVPLFGT4218	309	320	42	18	2 7/8
		EVPLFGT4224	366	379	42	24	2 7/8
		EVPLFGT4230	413	430	42	30	2 7/8
		EVPLFGT4236	460	480	42	36	2 7/8
		EVPLFGT4242	515	537	42	42	2 7/8
		EVPLFGT4248	561	585	42	48	2 7/8
		EVPLFGT4254	628	654	42	54	2 7/8
		EVPLFGT4260	694	722	42	60	2 7/8
	Partly Glazed Light Panel - Tempered Glass - 54” High	EVPLFGT5418	343	352	54	18	2 7/8
		EVPLFGT5424	398	411	54	24	2 7/8
		EVPLFGT5430	460	477	54	30	2 7/8
		EVPLFGT5436	523	543	54	36	2 7/8
		EVPLFGT5442	587	608	54	42	2 7/8
		EVPLFGT5448	640	663	54	48	2 7/8
		EVPLFGT5454	742	768	54	54	2 7/8
		EVPLFGT5460	842	872	54	60	2 7/8
	Partly Glazed Light Panel - Tempered Glass - 66” High	EVPLFGT6618	435	451	66	18	2 7/8
		EVPLFGT6624	504	524	66	24	2 7/8
		EVPLFGT6630	583	607	66	30	2 7/8
		EVPLFGT6636	663	690	66	36	2 7/8
		EVPLFGT6642	748	779	66	42	2 7/8
		EVPLFGT6648	812	846	66	48	2 7/8
		EVPLFGT6654	932	972	66	54	2 7/8
		EVPLFGT6660	1057	1099	66	60	2 7/8

**EVPPFGTX - PARTLY GLAZED PANEL - 36”H TEMPERED GLASS**

- Partly Glazed Panel incorporates a lower fabric module with 36”H top position glazed module, into a solid steel frame.
- Opposite sides of each panel may have a different fabric within the same grade at no upcharge.
- If different grades of fabric are used on one panel, the entire panel must be priced at highest grade.
- An aluminum low profile top cap is included.
- Stackability: Evolve panels can be increased in height in 6”H, 12”H, 18”H or 24”H increments. See Extension Module (pages 82-90) for part numbers.
- Standard in clear (CLR) or smoked glass (SMK) as an option.
- Frosted glass (FRST) 40% upcharge.

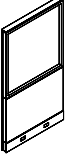
	DESCRIPTION	PRODUCT CODE	LIST PRICE		DIMENSIONS/INCHES		
			Gr1	Gr2	H	W	D
	Fabric 36” Glazed Panel -	EVPPFGTX6618	512	521	66	18	2 7/8
	Tempered Glass - 66” High	EVPPFGTX6624	567	581	66	24	2 7/8
		EVPPFGTX6630	656	673	66	30	2 7/8
		EVPPFGTX6636	747	765	66	36	2 7/8
		EVPPFGTX6642	835	857	66	42	2 7/8
		EVPPFGTX6648	915	938	66	48	2 7/8
		EVPPFGTX6654	1006	1032	66	54	2 7/8
		EVPPFGTX6660	1097	1127	66	60	2 7/8

**EVPLFGTX - PARTLY GLAZED LIGHT PANEL - 36”H TEMPERED GLASS**

- Partly Glazed Light Panel incorporates a lower fabric module with 36”H top position glazed module, into a solid steel frame.
- There is no base raceway in Light Panels to accommodate electrical.
- Light Panel Connectors must be used in conjunction with Light Panels.
- Opposite sides of each panel may have a different fabric within the same grade at no upcharge.
- If different grades of fabric are used on one panel, the entire panel must be priced at highest grade.
- An aluminum low profile top cap is included.
- Stackability: Evolve panels can be increased in height in 6”H, 12”H, 18”H or 24”H increments. See Extension Module (pages 82-90) for part numbers.
- Standard in clear (CLR) or smoked glass (SMK) as an option.
- Frosted glass (FRST) 40% upcharge.

	DESCRIPTION	PRODUCT CODE	LIST PRICE		DIMENSIONS/INCHES		
			Gr1	Gr2	H	W	D
	Partly Glazed Light Panel -	EVPLFGTX6618	496	506	66	18	2 7/8
	36”H Tempered Glass - 66” High	EVPLFGTX6624	549	563	66	24	2 7/8
		EVPLFGTX6630	637	652	66	30	2 7/8
		EVPLFGTX6636	723	743	66	36	2 7/8
		EVPLFGTX6642	810	830	66	42	2 7/8
		EVPLFGTX6648	888	911	66	48	2 7/8
		EVPLFGTX6654	975	1000	66	54	2 7/8
		EVPLFGTX6660	1064	1094	66	60	2 7/8



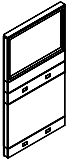

**EVPBFGT - PARTLY GLAZED BELTLINE POWERED PANEL**

- Partly Glazed Beltline Powered Panel incorporates fabric modules with a power beltline raceway and a 12”H or 24”H glazed module, within a solid steel frame.
- A Chimney Panel is required to run electric and data from the base to belt.
- 6”H power beltline raceway, to accommodate electrical, is metal with knockouts on both sides.
- Beltline Connectors must be used in conjunction with beltline panels.
- Opposite sides of each panel may have a different fabric within the same grade at no upcharge.
- If different grades of fabric are used on one panel, the entire panel must be priced at highest grade.
- An aluminum low profile top cap is included.
- Stackability: Evolve panels can be increased in height in 6”H, 12”H, 18”H or 24”H increments. See Extension Module (pages 82-90) for part numbers.
- Standard in clear (CLR) or smoked glass (SMK) as an option.
- Frosted glass (FRST) 20% upcharge.

	DESCRIPTION	PRODUCT CODE	LIST PRICE		DIMENSIONS/INCHES		
			Gr1	Gr2	H	W	D
	Partly Glazed Beltline Powered Panel - 54” High	EVPBFGT5424	518	535	54	24	2 7/8
	24” Fabric /6” Power Belt/ 6” Fabric /12” Glass	EVPBFGT5430	607	626	54	30	2 7/8
		EVPBFGT5436	690	714	54	36	2 7/8
		EVPBFGT5442	778	804	54	42	2 7/8
		EVPBFGT5448	861	891	54	48	2 7/8
		EVPBFGT5454	946	979	54	54	2 7/8
		EVPBFGT5460	1031	1067	54	60	2 7/8
	Partly Glazed Beltline Powered Panel - 66” High	EVPBFGT6624	588	605	66	24	2 7/8
	24” Fabric /6” Power Belt/ 6” Fabric /24” Glass	EVPBFGT6630	686	706	66	30	2 7/8
		EVPBFGT6636	780	803	66	36	2 7/8
		EVPBFGT6642	877	903	66	42	2 7/8
		EVPBFGT6648	968	998	66	48	2 7/8
		EVPBFGT6654	1064	1087	66	54	2 7/8
		EVPBFGT6660	1158	1194	66	60	2 7/8

**EVPBLFGT - PARTLY GLAZED BELTLINE POWER LIGHT PANEL**

- Partly Glazed Beltline Powered Light Panel incorporates fabric modules with a power beltline raceway and a 12”H or 24”H glazed module, within a solid steel frame.
- 6”H power beltline raceway, to accommodate electrical, is metal with knockouts on both sides.
- There is no base raceway in Light Panels to accommodate electrical.
- Light Beltline Panel Connectors must be used in conjunction with Light Beltline Panels.
- Opposite sides of each panel may have a different fabric within the same grade at no upcharge.
- If different grades of fabric are used on one panel, the entire panel must be priced at highest grade.
- An aluminum low profile top cap is included.
- Stackability: Evolve Light panels can be increased in height in 6”H, 12”H, 18”H or 24”H increments. See Extension Module (pages 82-90) for part numbers.
- Standard in clear (CLR) or smoked glass (SMK) as an option.
- Frosted glass (FRST) 20% upcharge.

	DESCRIPTION	PRODUCT CODE	LIST PRICE		DIMENSIONS/INCHES		
			Gr1	Gr2	H	W	D
	Partly Glazed Beltline Powered Light Panel - 54” High	EVPBLFGT5424	492	509	54	24	2 7/8
	24” Fabric /6” Power Belt/ 6” Fabric /12” Glass	EVPBLFGT5430	577	596	54	30	2 7/8
		EVPBLFGT5436	655	679	54	36	2 7/8
		EVPBLFGT5442	739	765	54	42	2 7/8
		EVPBLFGT5448	818	848	54	48	2 7/8
		EVPBLFGT5454	899	932	54	54	2 7/8
		EVPBLFGT5460	979	1016	54	60	2 7/8
	Partly Glazed Beltline Powered Light Panel - 66” High	EVPBLFGT6624	542	558	66	24	2 7/8
	24” Fabric /6” Power Belt/ 6” Fabric /24” Glass	EVPBLFGT6630	651	671	66	30	2 7/8
		EVPBLFGT6636	741	764	66	36	2 7/8
		EVPBLFGT6642	831	859	66	42	2 7/8
		EVPBLFGT6648	921	951	66	48	2 7/8
		EVPBLFGT6654	1011	1044	66	54	2 7/8
		EVPBLFGT6660	1100	1137	66	60	2 7/8



**EVPBCFGT - PARTLY GLAZED BELTLINE POWERED CHIMNEY PANEL - TEMPERED GLASS**

- Partly Glazed Beltline Powered Chimney Panel incorporates fabric modules with a power beltline raceway and a 12”H or 24”H glazed module, within a solid steel frame.
- A Chimney Panel is required to run electric and data from the base to belt.
- Separate electric harness required to go from base to belt (see EVE8CPCP).
- 6”H power beltline raceway, to accommodate electrical, is metal with knockouts on both sides.
- Beltline Connectors must be used in conjunction with beltline panels.
- Opposite sides of each panel may have a different fabric within the same grade at no upcharge.
- If different grades of fabric are used on one panel, the entire panel must be priced at highest grade.
- An aluminum low profile top cap is included.
- Stackability: Evolve panels can be increased in height in 6”H, 12”H, 18”H or 24”H increments. See Extension Module (pages 82-90) for part numbers.
- Standard in clear (CLR) or smoked glass (SMK) as an option.
- Frosted glass (FRST) 20% upcharge.

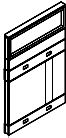
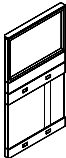
	DESCRIPTION	PRODUCT CODE	LIST PRICE		DIMENSIONS/INCHES		
			Gr1	Gr2	H	W	D
	Partly Glazed Beltline Powered Chimney Panel - Tempered Glass - 54” High	EVPBCFGT5436	744	768	54	36	2 7/8
	24” Fabric Chimney /6” Power Belt / 6” Fabric /12” Glass	EVPBCFGT5442	831	859	54	42	2 7/8
	Partly Glazed Beltline Powered Chimney Panel - Tempered Glass - 66” High	EVPBCFGT6636	845	868	66	36	2 7/8
	24” Fabric Chimney /6” Power Belt / 6” Fabric /24” Glass	EVPBCFGT6642	930	957	66	42	2 7/8

**EVE8CPCP - CHIMNEY PANEL JUMPER CABLE KIT**

- Contains two (2) 17” flexible harnesses and one (1) “I” connector.
- Used to connect electric from the base to the beltline raceway in Beltline Powered Chimney panel.
- Must use in conjunction with base power distribution harness and beltline power distribution harness (sold separately)

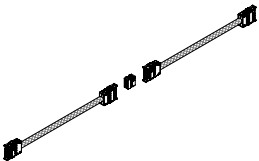
	DESCRIPTION	PRODUCT CODE	LIST PRICE	DIMENSIONS/INCHES		
				H	W	D
	Chimney Panel Jumper Cable Kit	EVE8CPCP	229			



**EVFPFGT - PARTLY GLAZED PREMIUM PANEL - TEMPERED GLASS**

- Partly Glazed Premium Panel incorporates 12”H glazed modules above 30”H fabric base section.
- Opposite sides of each panel may have a different fabric within the same grade at no upcharge.
- If different grades of fabric are used on one panel, the entire panel must be priced at highest grade.
- An aluminum low profile top cap is included.
- Stackability: Evolve panels can be increased in height in 6”H, 12”H, 18”H or 24”H increments. See Extension Module (pages 82-90) for part numbers.
- Standard in clear (CLR) or smoked glass (SMK) as an option.
- Frosted glass (FRST) 20% upcharge.

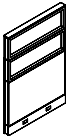
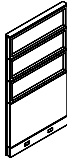
	DESCRIPTION	PRODUCT CODE	LIST PRICE		DIMENSIONS/INCHES		
			Gr1	Gr2	H	W	D
	Partly Glazed Premium Panel - Tempered Glass - 54” High	EVFPFGT5418	422	434	54	18	2 7/8
		EVFPFGT5424	504	516	54	24	2 7/8
		EVFPFGT5430	564	581	54	30	2 7/8
		EVFPFGT5436	628	648	54	36	2 7/8
		EVFPFGT5442	699	721	54	42	2 7/8
		EVFPFGT5448	770	794	54	48	2 7/8
		EVFPFGT5454	861	889	54	54	2 7/8
		EVFPFGT5460	950	981	54	60	2 7/8
	Partly Glazed Premium Panel - Tempered Glass - 66” High	EVFPFGT6618	527	538	66	18	2 7/8
		EVFPFGT6624	634	650	66	24	2 7/8
		EVFPFGT6630	711	727	66	30	2 7/8
		EVFPFGT6636	784	803	66	36	2 7/8
		EVFPFGT6642	874	896	66	42	2 7/8
		EVFPFGT6648	965	990	66	48	2 7/8
		EVFPFGT6654	1090	1119	66	54	2 7/8
		EVFPFGT6660	1215	1246	66	60	2 7/8

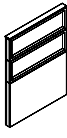
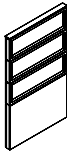

**EVPLFPGT - PARTLY GLAZED PREMIUM LIGHT PANEL – TEMPERED GLASS**

- Partly Glazed Premium Panel incorporates 12”H glazed modules above 30”H fabric base section.
- There is no base raceway in Light Panels to accommodate electrical.
- Light Panel Connectors must be used in conjunction with Light Panels.
- Opposite sides of each panel may have a different fabric within the same grade at no upcharge.
- If different grades of fabric are used on one panel, the entire panel must be priced at highest grade.
- An aluminum low profile top cap is included.
- Stackability: Evolve panels can be increased in height in 6”H, 12”H, 18”H or 24”H increments.
- See Extension Module (pages 82-90) for part numbers.
- Standard in clear (CLR) or smoked glass (SMK) as an option.
- Frosted glass (FRST) 20% upcharge.

	DESCRIPTION	PRODUCT CODE	LIST PRICE		DIMENSIONS/INCHES		
			Gr1	Gr2	H	W	D
	Partly Glazed Premium Light Panel - Tempered Glass - 54” High	EVPLFPGT5418	409	420	54	18	2 7/8
		EVPLFPGT5424	489	501	54	24	2 7/8
		EVPLFPGT5430	547	563	54	30	2 7/8
		EVPLFPGT5436	610	628	54	36	2 7/8
		EVPLFPGT5442	679	699	54	42	2 7/8
		EVPLFPGT5448	748	770	54	48	2 7/8
		EVPLFPGT5454	835	862	54	54	2 7/8
		EVPLFPGT5460	922	952	54	60	2 7/8
	Partly Glazed Premium Light Panel - Tempered Glass - 66” High	EVPLFPGT6618	512	521	66	18	2 7/8
		EVPLFPGT6624	615	630	66	24	2 7/8
		EVPLFPGT6630	689	706	66	30	2 7/8
		EVPLFPGT6636	760	780	66	36	2 7/8
		EVPLFPGT6642	849	869	66	42	2 7/8
		EVPLFPGT6648	935	960	66	48	2 7/8
		EVPLFPGT6654	1058	1085	66	54	2 7/8
		EVPLFPGT6660	1179	1208	66	60	2 7/8

**EVPXGT - FULLY GLAZED MONOLITHIC PANEL - TEMPERED GLASS**

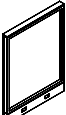
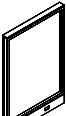
- Fully Glazed Monolithic Panels are incorporated into a solid steel frame.
- An aluminum low profile top cap is included.
- Stackability: Evolve panels can be increased in height in 6"H, 12"H, 18"H or 24"H increments. See Extension Module (pages 82-90) for part numbers.
- Standard in clear (CLR) or smoked glass (SMK) as an option.
- Frosted glass (FRST) 40% upcharge.

	DESCRIPTION	PRODUCT CODE	LIST PRICE	DIMENSIONS/INCHES		
				H	W	D
	Fully Glazed Monolithic Panel - Tempered Glass - 42" High	EVPXGT4218	339	42	18	2 7/8
		EVPXGT4224	373	42	24	2 7/8
		EVPXGT4230	434	42	30	2 7/8
		EVPXGT4236	488	42	36	2 7/8
		EVPXGT4242	543	42	42	2 7/8
	Fully Glazed Monolithic Panel - Tempered Glass - 48" High	EVPXGT4818	301	48	18	2 7/8
		EVPXGT4824	386	48	24	2 7/8
		EVPXGT4830	427	48	30	2 7/8
		EVPXGT4836	527	48	36	2 7/8
		EVPXGT4842	555	48	42	2 7/8
	Fully Glazed Monolithic Panel - Tempered Glass - 54" High	EVPXGT5418	375	54	18	2 7/8
		EVPXGT5424	441	54	24	2 7/8
		EVPXGT5430	511	54	30	2 7/8
		EVPXGT5436	577	54	36	2 7/8
		EVPXGT5442	640	54	42	2 7/8
	Fully Glazed Monolithic Panel - Tempered Glass - 66" High	EVPXGT6618	440	66	18	2 7/8
		EVPXGT6624	509	66	24	2 7/8
		EVPXGT6630	588	66	30	2 7/8
		EVPXGT6636	662	66	36	2 7/8
		EVPXGT6642	736	66	42	2 7/8



**EVPLXGT - FULLY GLAZED MONOLITHIC LIGHT PANEL - TEMPERED GLASS**

- Fully Glazed Monolithic Light Panels are incorporated into a solid steel frame.
- There is no base raceway in Light Panels to accommodate electrical.
- Light Panel Connectors must be used in conjunction with Light Panels.
- An aluminum low profile top cap is included.
- Stackability: Evolve panels can be increased in height in 6”H, 12”H, 18”H or 24”H increments. See Extension Module (pages 82-90) for part numbers.
- Standard in clear (CLR) or smoked glass (SMK) as an option.
- Frosted glass (FRST) 40% upcharge.

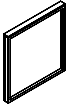
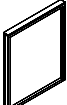
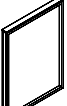
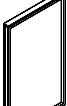
	DESCRIPTION	PRODUCT CODE	LIST PRICE	DIMENSIONS/INCHES		
				H	W	D
	Fully Glazed Monolithic Light Panel - Tempered Glass - 42” High	EVPLXGT4218	321	42	18	2 7/8
		EVPLXGT4224	354	42	24	2 7/8
		EVPLXGT4230	412	42	30	2 7/8
		EVPLXGT4236	462	42	36	2 7/8
		EVPLXGT4242	516	42	42	2 7/8
	Fully Glazed Monolithic Light Panel - Tempered Glass - 48” High	EVPLXGT4818	285	48	18	2 7/8
		EVPLXGT4824	367	48	24	2 7/8
		EVPLXGT4830	406	48	30	2 7/8
		EVPLXGT4836	502	48	36	2 7/8
		EVPLXGT4842	526	48	42	2 7/8
	Fully Glazed Monolithic Light Panel - Tempered Glass - 54	EVPLXGT5418	357	54	18	2 7/8
		EVPLXGT5424	419	54	24	2 7/8
		EVPLXGT5430	484	54	30	2 7/8
		EVPLXGT5436	547	54	36	2 7/8
		EVPLXGT5442	607	54	42	2 7/8
	Fully Glazed Monolithic Light Panel - Tempered Glass - 66” High	EVPLXGT6618	418	66	18	2 7/8
		EVPLXGT6624	483	66	24	2 7/8
		EVPLXGT6630	559	66	30	2 7/8
		EVPLXGT6636	628	66	36	2 7/8
		EVPLXGT6642	699	66	42	2 7/8

**EVPGT - FULLY GLAZED SEGMENTED PANEL - TEMPERED GLASS**

- Fully Glazed Segmented Panel incorporates (2) 24”H Glazed modules into a solid steel frame.
- An aluminum low profile top cap is included.
- Stackability: Evolve panels can be increased in height in 6”H, 12”H, 18”H or 24”H increments. See Extension Module (pages 82-90) for part numbers.
- Standard in clear (CLR) or smoked glass (SMK) as an option.
- Frosted glass (FRST) 40% upcharge.

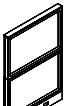
	DESCRIPTION	PRODUCT CODE	LIST PRICE	DIMENSIONS/INCHES		
				H	W	D
	Fully Glazed Segmented Panel - Tempered Glass - 54” High	EVPGT5418	480	54	18	2 7/8
		EVPGT5424	589	54	24	2 7/8
		EVPGT5430	651	54	30	2 7/8
		EVPGT5436	711	54	36	2 7/8
		EVPGT5442	788	54	42	2 7/8
		EVPGT5448	879	54	48	2 7/8
		EVPGT5454	968	54	54	2 7/8
		EVPGT5460	1057	54	60	2 7/8

**EVPLGT - FULLY GLAZED SEGMENTED LIGHT PANEL - TEMPERED GLASS**

- Fully Glazed Segmented Light Panel incorporates (2) 24”H Glazed modules into a solid steel frame.
- There is no base raceway in Light Panels to accommodate electrical.
- Light Panel Connectors must be used in conjunction with Light Panels.
- An aluminum low profile top cap is included.
- Stackability: Evolve panels can be increased in height in 6”H, 12”H, 18”H or 24”H increments. See Extension Module (pages 82-90) for part numbers.
- Standard in clear (CLR) or smoked glass (SMK) as an option.
- Frosted glass (FRST) 40% upcharge.

	DESCRIPTION	PRODUCT CODE	LIST PRICE	DIMENSIONS/INCHES		
				H	W	D
	Fully Glazed Segmented Light Panel Tempered Glass - 54” High	EVPLGT5418	456	54	18	2 7/8
		EVPLGT5424	560	54	24	2 7/8
		EVPLGT5430	619	54	30	2 7/8
		EVPLGT5436	675	54	36	2 7/8
		EVPLGT5442	750	54	42	2 7/8
		EVPLGT5448	834	54	48	2 7/8
		EVPLGT5454	920	54	54	2 7/8
		EVPLGT5460	1003	54	60	2 7/8

**EVPGPT - FULLY GLAZED PREMIUM PANEL - TEMPERED GLASS**

- Fully Glazed Premium Panel incorporates 12”H Glazed Modules into a solid steel frame.
- An aluminum low profile top cap is included.
- Stackability: Evolve panels can be increased in height in 6”H, 12”H, 18”H or 24”H increments. See Extension Module (pages 82-90) for part numbers.
- Standard in clear (CLR) or smoked glass (SMK) as an option.
- Frosted glass (FRST) 40% upcharge.

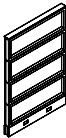
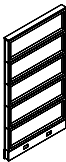
	DESCRIPTION	PRODUCT CODE	LIST PRICE	DIMENSIONS/INCHES		
				H	W	D
	Fully Glazed Premium Panel - Tempered Glass - 42” High	EVPGPT4218	473	42	18	2 7/8
		EVPGPT4224	579	42	24	2 7/8
		EVPGPT4230	642	42	30	2 7/8
		EVPGPT4236	699	42	36	2 7/8
		EVPGPT4242	777	42	42	2 7/8
		EVPGPT4248	863	42	48	2 7/8
		EVPGPT4254	951	42	54	2 7/8
		EVPGPT4260	1037	42	60	2 7/8
	Fully Glazed Premium Panel - Tempered Glass - 54” High	EVPGPT5418	600	54	18	2 7/8
		EVPGPT5424	736	54	24	2 7/8
		EVPGPT5430	814	54	30	2 7/8
		EVPGPT5436	888	54	36	2 7/8
		EVPGPT5442	986	54	42	2 7/8
		EVPGPT5448	1098	54	48	2 7/8
		EVPGPT5454	1210	54	54	2 7/8
		EVPGPT5460	1320	54	60	2 7/8
	Fully Glazed Premium Panel - Tempered Glass - 66” High	EVPGPT6618	726	66	18	2 7/8
		EVPGPT6624	892	66	24	2 7/8
		EVPGPT6630	988	66	30	2 7/8
		EVPGPT6636	1074	66	36	2 7/8
		EVPGPT6642	1193	66	42	2 7/8
		EVPGPT6648	1329	66	48	2 7/8
		EVPGPT6654	1467	66	54	2 7/8
		EVPGPT6660	1603	66	60	2 7/8



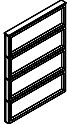
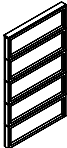

**EVPLGPT - FULLY GLAZED PREMIUM LIGHT PANEL - TEMPERED GLASS**

- Fully Glazed Premium Light Panel incorporates 12”H Glazed Modules into a solid steel frame.
- There is no base raceway in Light Panels to accommodate electrical.
- Light Panel Connectors must be used in conjunction with Light Panels.
- An aluminum low profile top cap is included.
- Stackability: Evolve panels can be increased in height in 6”H, 12”H, 18”H or 24”H increments. See Extension Module (pages 82-90) for part numbers.
- Standard in clear (CLR) or smoked glass (SMK) as an option.
- Frosted glass (FRST) 40% upcharge.

	DESCRIPTION	PRODUCT CODE	LIST PRICE	DIMENSIONS/INCHES		
				H	W	D
	Fully Glazed Premium Light Panel - Tempered Glass - 42” High	EVPLGPT4218	458	42	18	2 7/8
		EVPLGPT4224	561	42	24	2 7/8
		EVPLGPT4230	622	42	30	2 7/8
		EVPLGPT4236	679	42	36	2 7/8
		EVPLGPT4242	753	42	42	2 7/8
		EVPLGPT4248	837	42	48	2 7/8
		EVPLGPT4254	923	42	54	2 7/8
EVPLGPT4260	1006	42	60	2 7/8		
	Fully Glazed Premium Light Panel - Tempered Glass - 54” High	EVPLGPT5418	582	54	18	2 7/8
		EVPLGPT5424	715	54	24	2 7/8
		EVPLGPT5430	788	54	30	2 7/8
		EVPLGPT5436	861	54	36	2 7/8
		EVPLGPT5442	956	54	42	2 7/8
		EVPLGPT5448	1065	54	48	2 7/8
		EVPLGPT5454	1173	54	54	2 7/8
EVPLGPT5460	1280	54	60	2 7/8		
	Fully Glazed Premium Light Panel - Tempered Glass - 66” High	EVPLGPT6618	705	66	18	2 7/8
		EVPLGPT6624	865	66	24	2 7/8
		EVPLGPT6630	958	66	30	2 7/8
		EVPLGPT6636	1041	66	36	2 7/8
		EVPLGPT6642	1158	66	42	2 7/8
		EVPLGPT6648	1290	66	48	2 7/8
		EVPLGPT6654	1422	66	54	2 7/8
EVPLGPT6660	1555	66	60	2 7/8		

**EVPFSG - PASS-THRU SLIDING DOOR GLAZED PANEL - TEMPERED GLASS**

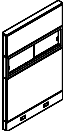
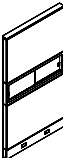
- Pass-Thru Sliding Door Glazed Panel incorporates fabric modules on upper and lower positions, with Middle 12”H Pass-Thru Sliding Door module, into a solid steel frame.
- Tracks for Sliding glass door available in Tungsten only.
- Opposite sides of each panel may have a different fabric within the same grade at no upcharge.
- If different grades of fabric are used on one panel, the entire panel must be priced at highest grade.
- An aluminum low profile top cap is included.
- Stackability: Evolve panels can be increased in height in 6”H, 12”H, 18”H or 24”H increments. See Extension Module (pages 82-90) for part numbers.
- Standard in clear (CLR) or smoked glass (SMK) as an option.
- Frosted glass (FRST) 20% upcharge.

	DESCRIPTION	PRODUCT CODE	LIST PRICE		DIMENSIONS/INCHES		
			Gr1	Gr2	H	W	D
	Pass-Thru Sliding Door Glazed Panel - Tempered Glass - 54” High	EVPFSG5424	482	502	54	24	2 7/8
		EVPFSG5430	545	570	54	30	2 7/8
		EVPFSG5436	613	642	54	36	2 7/8
		EVPFSG5442	689	721	54	42	2 7/8
		EVPFSG5448	748	783	54	48	2 7/8
		EVPFSG5454	838	878	54	54	2 7/8
	Pass-Thru Sliding Door Glazed Panel - Tempered Glass - 66” High	EVPFSG6624	521	548	66	24	2 7/8
		EVPFSG6630	595	626	66	30	2 7/8
		EVPFSG6636	667	705	66	36	2 7/8
		EVPFSG6642	752	793	66	42	2 7/8
		EVPFSG6648	816	863	66	48	2 7/8
		EVPFSG6654	912	964	66	54	2 7/8
	Pass-Thru Sliding Door Glazed Panel - Tempered Glass - 66” High	EVPFPSG6624	521	548	66	24	2 7/8
		EVPFPSG6630	595	626	66	30	2 7/8
		EVPFPSG6636	667	705	66	36	2 7/8
		EVPFPSG6642	752	793	66	42	2 7/8
		EVPFPSG6648	816	863	66	48	2 7/8
		EVPFPSG6654	912	964	66	54	2 7/8
		EVPFPSG6660	1027	1063	66	60	2 7/8



**EVPFSGX - FABRIC GLAZED PASS-THRU SLIDING DOOR PANEL - TEMPERED GLASS**

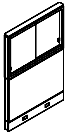
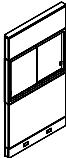

- Pass-Thru Sliding Door Glazed Panel incorporates fabric modules with 12”H or 24”H Pass-Thru Sliding Door module, into a solid steel frame.
- Tracks for Sliding glass door available in Tungsten only.
- Opposite sides of each panel may have a different fabric within the same grade at no upcharge.
- If different grades of fabric are used on one panel, the entire panel must be priced at highest grade.
- An aluminum low profile top cap is included.
- Stackability: Evolve panels can be increased in height in 6”H, 12”H, 18”H or 24”H increments. See Extension Module (pages 82-90) for part numbers.
- Standard in clear (CLR) or smoked glass (SMK) as an option.
- Frosted glass (FRST) 20% upcharge.

	DESCRIPTION	PRODUCT CODE	LIST PRICE		DIMENSIONS/INCHES		
			Gr1	Gr2	H	W	D
	Fabric Glazed Pass-Thru Sliding Door Panel - Tempered Glass - 42” High	EVPFSGX4224	373	386	42	24	2 7/8
		EVPFSGX4230	422	438	42	30	2 7/8
		EVPFSGX4236	471	490	42	36	2 7/8
		EVPFSGX4242	525	547	42	42	2 7/8
		EVPFSGX4248	574	597	42	48	2 7/8
		EVPFSGX4254	642	667	42	54	2 7/8
		EVPFSGX4260	709	737	42	60	2 7/8
	Fabric Glazed Pass-Thru Sliding Door Panel - Tempered Glass - 54” High	EVPFSGX5424	406	419	54	24	2 7/8
		EVPFSGX5430	471	487	54	30	2 7/8
		EVPFSGX5436	535	554	54	36	2 7/8
		EVPFSGX5442	599	620	54	42	2 7/8
		EVPFSGX5448	652	676	54	48	2 7/8
		EVPFSGX5454	757	783	54	54	2 7/8
		EVPFSGX5460	859	890	54	60	2 7/8
	Fabric Glazed Pass-Thru Sliding Door Panel - Tempered Glass - 66” High	EVPFSGX6624	515	536	66	24	2 7/8
		EVPFSGX6630	595	619	66	30	2 7/8
		EVPFSGX6636	677	705	66	36	2 7/8
		EVPFSGX6642	762	795	66	42	2 7/8
		EVPFSGX6648	827	863	66	48	2 7/8
		EVPFSGX6654	952	992	66	54	2 7/8
		EVPFSGX6660	1078	1122	66	60	2 7/8

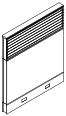
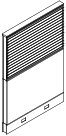

**EVPPF1S - SLATWALL PANEL - SINGLE SIDED**

- Slatwall Panel incorporates fabric modules with a single 12”H or 24”H top position slatwall module, into a solid steel frame.
- 66”H panel can be configured with either a 24”H slatwall module at the top or a 12”H slatwall at the middle Position (EVPPF1S66xxM)
- Opposite side is fabric covered.
- Slatwall is made of aluminum.
- Accessories can be used on slatwall modules. Please see accessory section for additional details.
- Opposite sides of each panel may have a different fabric within the same grade at no upcharge.
- If different grades of fabric are used on one panel, the entire panel must be priced at highest grade.
- An aluminum low profile top cap is included.
- Stackability: Evolve panels can be increased in height in 6”H, 12”H, 18”H or 24”H increments. See Extension Module (pages 82-90) for part numbers.

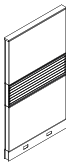
	DESCRIPTION	PRODUCT CODE	LIST PRICE		DIMENSIONS/INCHES		
			Gr1	Gr2	H	W	D
	Slatwall Panel - Single Sided - 42” High	EVPPF1S4218	352	366	42	18	2 7/8
		EVPPF1S4224	420	438	42	24	2 7/8
		EVPPF1S4230	493	513	42	30	2 7/8
		EVPPF1S4236	564	587	42	36	2 7/8
		EVPPF1S4242	642	667	42	42	2 7/8
		EVPPF1S4248	697	727	42	48	2 7/8
		EVPPF1S4254	775	806	42	54	2 7/8
		EVPPF1S4260	849	886	42	60	2 7/8
	Slatwall Panel - Single Sided - 54” High	EVPPF1S5418	415	430	54	18	2 7/8
		EVPPF1S5424	500	519	54	24	2 7/8
		EVPPF1S5430	585	609	54	30	2 7/8
		EVPPF1S5436	672	698	54	36	2 7/8
		EVPPF1S5442	760	793	54	42	2 7/8
		EVPPF1S5448	829	866	54	48	2 7/8
		EVPPF1S5454	924	964	54	54	2 7/8
		EVPPF1S5460	1016	1056	54	60	2 7/8
	Slatwall Panel - Single Sided - 66” High	EVPPF1S6618	528	545	66	18	2 7/8
		EVPPF1S6624	634	662	66	24	2 7/8
		EVPPF1S6630	743	775	66	30	2 7/8
		EVPPF1S6636	856	889	66	36	2 7/8
		EVPPF1S6642	973	1016	66	42	2 7/8
		EVPPF1S6648	1060	1102	66	48	2 7/8
		EVPPF1S6654	1179	1226	66	54	2 7/8
		EVPPF1S6660	1300	1350	66	60	2 7/8
	Slat Wall Panel - Single Sided - Middle Module - 66” High	EVPPF1S6618M	513	536	66	18	2 7/8
		EVPPF1S6624M	619	648	66	24	2 7/8
		EVPPF1S6630M	722	757	66	30	2 7/8
		EVPPF1S6636M	831	873	66	36	2 7/8
		EVPPF1S6642M	948	995	66	42	2 7/8
		EVPPF1S6648M	1031	1084	66	48	2 7/8
		EVPPF1S6654M	1147	1207	66	54	2 7/8
		EVPPF1S6660M	1262	1328	66	60	2 7/8



**EVPLF1S - SLATWALL LIGHT PANEL - SINGLE SIDED**

- Slatwall Light Panel incorporates fabric modules with a single 12”H or 24”H top position slatwall module, into a solid steel frame.
- 66”H panel can be configured with either a 24”H slatwall module at the top or a 12”H slatwall at the middle Position (EVPLF1S66xxM)
- Opposite side is fabric covered
- Slatwall is made of aluminum.
- Accessories can be used on slatwall modules. Please see accessory section for additional details.
- There is no base raceway in Light Panels to accommodate electrical.
- Light Panel Connectors must be used in conjunction with Light Panels.
- Opposite sides of each panel may have a different fabric within the same grade at no upcharge.
- If different grades of fabric are used on one panel, the entire panel must be priced at highest grade.
- An aluminum low profile top cap is included.
- Stackability: Evolve panels can be increased in height in 6”H, 12”H, 18”H or 24”H increments. See Extension Module (pages 82-90) for part numbers.

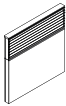
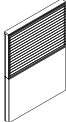
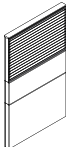
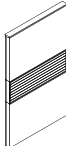
	DESCRIPTION	PRODUCT CODE	LIST PRICE		DIMENSIONS/INCHES		
			Gr1	Gr2	H	W	D
	Slatwall Light Panel - Single Sided- 42” High	EVPLF1S4218	345	358	42	18	2 7/8
		EVPLF1S4224	412	430	42	24	2 7/8
		EVPLF1S4230	483	503	42	30	2 7/8
		EVPLF1S4236	554	576	42	36	2 7/8
		EVPLF1S4242	628	654	42	42	2 7/8
		EVPLF1S4248	684	713	42	48	2 7/8
		EVPLF1S4254	759	791	42	54	2 7/8
		EVPLF1S4260	831	868	42	60	2 7/8
	Slatwall Light Panel - Single Sided - 54” High	EVPLF1S5418	407	420	54	18	2 7/8
		EVPLF1S5424	490	509	54	24	2 7/8
		EVPLF1S5430	574	597	54	30	2 7/8
		EVPLF1S5436	658	685	54	36	2 7/8
		EVPLF1S5442	745	777	54	42	2 7/8
		EVPLF1S5448	814	850	54	48	2 7/8
		EVPLF1S5454	905	945	54	54	2 7/8
		EVPLF1S5460	995	1034	54	60	2 7/8
	Slatwall Light Panel - Single Sided - 66” High	EVPLF1S6618	518	535	66	18	2 7/8
		EVPLF1S6624	622	649	66	24	2 7/8
		EVPLF1S6630	728	759	66	30	2 7/8
		EVPLF1S6636	838	871	66	36	2 7/8
		EVPLF1S6642	954	995	66	42	2 7/8
		EVPLF1S6648	1038	1080	66	48	2 7/8
		EVPLF1S6654	1155	1201	66	54	2 7/8
		EVPLF1S6660	1274	1324	66	60	2 7/8
	Slatwall Light Panel - Single Sided - Middle Module - 66” High	EVPLF1S6618M	503	524	66	18	2 7/8
		EVPLF1S6624M	607	634	66	24	2 7/8
		EVPLF1S6630M	709	742	66	30	2 7/8
		EVPLF1S6636M	816	857	66	36	2 7/8
		EVPLF1S6642M	928	975	66	42	2 7/8
		EVPLF1S6648M	1010	1062	66	48	2 7/8
		EVPLF1S6654M	1125	1183	66	54	2 7/8
		EVPLF1S6660M	1237	1301	66	60	2 7/8

**EVPF2S - SLATWALL PANEL - DOUBLE SIDED**

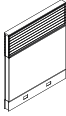
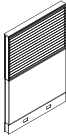
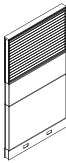
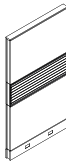

- Slatwall Panel incorporates fabric modules with a single 12”H or 24”H top position slatwall module, into a solid steel frame.
- 66”H panel can be configured with either a 24”H slatwall module at the top or a 12”H slatwall at the middle Position (EVPF2S66xxM)
- Slatwall module has slatwall on both sides.
- Slatwall is made of aluminum.
- Accessories can be used on slatwall modules. Please see accessory section for additional details.
- Opposite sides of each panel may have a different fabric within the same grade at no upcharge.
- If different grades of fabric are used on one panel, the entire panel must be priced at highest grade.
- An aluminum low profile top cap is included.
- Stackability: Evolve panels can be increased in height in 6”H, 12”H, 18”H or 24”H increments. See Extension Module (pages 82-90) for part numbers.

	DESCRIPTION	PRODUCT CODE	LIST PRICE		DIMENSIONS/INCHES		
			Gr1	Gr2	H	W	D
	Slatwall Panel - Double Sided - 42” High	EVPF2S4218	394	405	42	18	2 7/8
		EVPF2S4224	477	491	42	24	2 7/8
		EVPF2S4230	562	579	42	30	2 7/8
		EVPF2S4236	655	675	42	36	2 7/8
		EVPF2S4242	748	769	42	42	2 7/8
		EVPF2S4248	837	861	42	48	2 7/8
		EVPF2S4254	922	948	42	54	2 7/8
	Slatwall Panel - Double Sided - 54” High	EVPF2S5418	461	472	54	18	2 7/8
		EVPF2S5424	565	580	54	24	2 7/8
		EVPF2S5430	668	685	54	30	2 7/8
		EVPF2S5436	779	798	54	36	2 7/8
		EVPF2S5442	891	913	54	42	2 7/8
		EVPF2S5448	1001	1025	54	48	2 7/8
		EVPF2S5454	1102	1128	54	54	2 7/8
	Slatwall Panel - Double Sided - 66” High	EVPF2S6618	599	613	66	18	2 7/8
		EVPF2S6624	736	757	66	24	2 7/8
		EVPF2S6630	872	896	66	30	2 7/8
		EVPF2S6636	1012	1039	66	36	2 7/8
		EVPF2S6642	1159	1191	66	42	2 7/8
		EVPF2S6648	1300	1335	66	48	2 7/8
		EVPF2S6654	1435	1473	66	54	2 7/8
	Slatwall Panel - Double Sided - Middle Module - 66” High	EVPF2S6618M	582	603	66	18	2 7/8
		EVPF2S6624M	716	743	66	24	2 7/8
		EVPF2S6630M	849	880	66	30	2 7/8
		EVPF2S6636M	985	1020	66	36	2 7/8
		EVPF2S6642M	1127	1168	66	42	2 7/8
		EVPF2S6648M	1262	1310	66	48	2 7/8
		EVPF2S6654M	1396	1447	66	54	2 7/8
		EVPF2S6660M	1525	1583	66	60	2 7/8

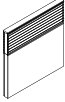
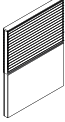

**EVPLF2S - SLATWALL LIGHT PANEL - DOUBLE SIDED**

- Slatwall Light Panel incorporates fabric modules with a single 12”H or 24”H top position slatwall module, into a solid steel frame.
- 66”H panel can be configured with either a 24”H slatwall module at the top or a 12”H slatwall at the middle Position (EVPLF2S66xxM)
- Slatwall module has slatwall on both sides.
- Slatwall is made of aluminum.
- Accessories can be used on slatwall modules. Please see accessory section for additional details.
- There is no base raceway in Light Panels to accommodate electrical.
- Light Panel Connectors must be used in conjunction with Light Panels.
- Opposite sides of each panel may have a different fabric within the same grade at no upcharge.
- If different grades of fabric are used on one panel, the entire panel must be priced at highest grade.
- An aluminum low profile top cap is included.
- Stackability: Evolve panels can be increased in height in 6”H, 12”H, 18”H or 24”H increments.
- See Extension Module (pages 82-90) for part numbers.

	DESCRIPTION	PRODUCT CODE	LIST PRICE		DIMENSIONS/INCHES		
			Gr1	Gr2	H	W	D
	Slatwall Light Panel - Double Sided - 42" High	EVPLF2S4218	387	397	42	18	2 7/8
		EVPLF2S4224	468	481	42	24	2 7/8
		EVPLF2S4230	552	567	42	30	2 7/8
		EVPLF2S4236	643	662	42	36	2 7/8
		EVPLF2S4242	732	754	42	42	2 7/8
		EVPLF2S4248	821	844	42	48	2 7/8
		EVPLF2S4254	903	928	42	54	2 7/8
		EVPLF2S4260	982	1012	42	60	2 7/8
	Slatwall Light Panel - Double Sided - 54" High	EVPLF2S5418	452	461	54	18	2 7/8
		EVPLF2S5424	555	568	54	24	2 7/8
		EVPLF2S5430	655	671	54	30	2 7/8
		EVPLF2S5436	763	782	54	36	2 7/8
		EVPLF2S5442	873	894	54	42	2 7/8
		EVPLF2S5448	981	1004	54	48	2 7/8
		EVPLF2S5454	1080	1105	54	54	2 7/8
		EVPLF2S5460	1176	1206	54	60	2 7/8
	Slatwall Light Panel - Double Sided - 66" High	EVPLF2S6618	587	602	66	18	2 7/8
		EVPLF2S6624	721	742	66	24	2 7/8
		EVPLF2S6630	856	879	66	30	2 7/8
		EVPLF2S6636	992	1019	66	36	2 7/8
		EVPLF2S6642	1136	1167	66	42	2 7/8
		EVPLF2S6648	1274	1307	66	48	2 7/8
		EVPLF2S6654	1406	1444	66	54	2 7/8
		EVPLF2S6660	1536	1579	66	60	2 7/8
	Slatwall Light Panel - Double Sided - 66" High	EVPLF2S6618M	565	590	66	18	2 7/8
		EVPLF2S6624M	701	728	66	24	2 7/8
		EVPLF2S6630M	831	862	66	30	2 7/8
		EVPLF2S6636M	965	999	66	36	2 7/8
		EVPLF2S6642M	1104	1144	66	42	2 7/8
		EVPLF2S6648M	1237	1283	66	48	2 7/8
		EVPLF2S6654M	1367	1418	66	54	2 7/8
		EVPLF2S6660M	1495	1552	66	60	2 7/8

**EVPS2FA - FRAMELESS SLATWALL PANEL - DOUBLE SIDED ONLY**

- Frameless Slatwall Panel incorporates fabric modules with a single 12”H slatwall module, into a solid steel frame.
- Slatwall module has slatwall on both sides only, and is not available Single Sided.
- Slatwall is made of aluminum.
- Slatwall is not encompassed within a frame, as standard Slatwall modules are.
- Accessories can be used on slatwall modules. Please see accessory section for additional details.
- Opposite sides of each panel may have a different fabric within the same grade at no upcharge.
- If different grades of fabric are used on one panel, the entire panel must be priced at highest grade.
- An aluminum low profile top cap is included.
- Stackability: Evolve panels can be increased in height in 6”H, 12”H, 18”H or 24”H increments. See Extension Module (pages 82-90) for part numbers.

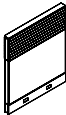
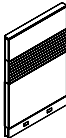
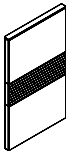
	DESCRIPTION	PRODUCT CODE	LIST PRICE		DIMENSIONS/INCHES		
			Gr1	Gr2	H	W	D
	Frameless Slatwall Panel -	EVPS2FA4224	409	422	42	24	2 7/8
	Double Sided Only - 42” High	EVPS2FA4230	483	491	42	30	2 7/8
		EVPS2FA4236	574	591	42	36	2 7/8
		EVPS2FA4242	645	666	42	42	2 7/8
		EVPS2FA4248	716	740	42	48	2 7/8
		EVPS2FA4254	788	814	42	54	2 7/8
		EVPS2FA4260	862	891	42	60	2 7/8
	Frameless Slatwall Panel -	EVPS2FA5424	451	471	54	24	2 7/8
	Double Sided Only - 54” High	EVPS2FA5430	529	553	54	30	2 7/8
		EVPS2FA5436	640	666	54	36	2 7/8
		EVPS2FA5442	717	748	54	42	2 7/8
		EVPS2FA5448	784	820	54	48	2 7/8
		EVPS2FA5454	863	903	54	54	2 7/8
		EVPS2FA5460	945	989	54	60	2 7/8
	Frameless Slatwall Panel -	EVPS2FA6624	608	632	66	24	2 7/8
	Double Sided Only - 66” High	EVPS2FA6630	711	743	66	30	2 7/8
		EVPS2FA6636	839	876	66	36	2 7/8
		EVPS2FA6642	942	985	66	42	2 7/8
		EVPS2FA6648	1043	1091	66	48	2 7/8
		EVPS2FA6654	1148	1200	66	54	2 7/8
		EVPS2FA6660	1263	1319	66	60	2 7/8



**EVPBSFA - FRAMELESS SLATWALL BELTLINE POWERED PANEL - DOUBLE SIDED ONLY**

- Frameless Slatwall Beltline Powered Panel incorporates fabric modules with a single 6”H slatwall module above a power beltline raceway, into a solid steel frame.
- Slatwall module has slatwall on both sides only, and is not available Single Sided.
- Slatwall is made of aluminum.
- Slatwall is not encompassed within a frame.
- A Chimney Panel is required to run electric and data from the base to belt
- 6”H power beltline raceway, to accommodate electrical, is metal with knockouts on both sides.
- Beltline Connectors must be used in conjunction with beltline panels.
- Accessories can be used on slatwall modules. Please see accessory section for additional details.
- Opposite sides of each panel may have a different fabric within the same grade at no upcharge.
- If different grades of fabric are used on one panel, the entire panel must be priced at highest grade.
- An aluminum low profile top cap is included.
- Stackability: Evolve panels can be increased in height in 6”H, 12”H, 18”H or 24”H increments. See Extension Module (pages 82-90) for part numbers.

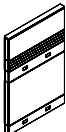
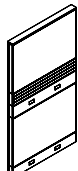
	DESCRIPTION	PRODUCT CODE	LIST PRICE		DIMENSIONS/INCHES		
			Gr1	Gr2	H	W	D
	Frameless Slatwall Beltline Powered Panel - Double Sided Only - 42” High	EVPBSFA4224	349	363	42	24	2 7/8
		EVPBSFA4230	407	421	42	30	2 7/8
		EVPBSFA4236	474	491	42	36	2 7/8
		EVPBSFA4242	533	554	42	42	2 7/8
		EVPBSFA4248	588	630	42	48	2 7/8
		EVPBSFA4254	647	673	42	54	2 7/8
	Frameless Slatwall Beltline Powered Panel - Double Sided Only - 54” High	EVPBSFA5424	442	461	54	24	2 7/8
		EVPBSFA5430	513	537	54	30	2 7/8
		EVPBSFA5436	607	633	54	36	2 7/8
		EVPBSFA5442	679	710	54	42	2 7/8
		EVPBSFA5448	748	784	54	48	2 7/8
		EVPBSFA5454	812	852	54	54	2 7/8
	Frameless Slatwall Beltline Powered Panel - Double Sided Only - 66” High	EVPBSFA6624	492	517	66	24	2 7/8
		EVPBSFA6630	571	603	66	30	2 7/8
		EVPBSFA6636	660	696	66	36	2 7/8
		EVPBSFA6642	741	783	66	42	2 7/8
		EVPBSFA6648	819	866	66	48	2 7/8
		EVPBSFA6654	897	949	66	54	2 7/8
		EVPBSFA6660	975	1032	66	60	2 7/8

**EVPBLSFA - FRAMELESS SLATWALL BELTLINE POWERED LIGHT PANEL - DOUBLE SIDED ONLY**

- Frameless Slatwall Beltline Powered Light Panel incorporates fabric modules with a single 6”H slatwall module above a power beltline raceway, into a solid steel frame.
- Slatwall module has slatwall on both sides only, and is not available Single Sided.
- Slatwall is made of aluminum.
- Slatwall is not encompassed within a frame.
- 6”H power beltline raceway, to accommodate electrical, is metal with knockouts on both sides.
- There is no base raceway in Light Panels to accommodate electrical.
- Light Beltline Panel Connectors must be used in conjunction with Light Beltline Panels.
- Accessories can be used on slatwall modules. Please see accessory section for additional details.
- Opposite sides of each panel may have a different fabric within the same grade at no upcharge.
- If different grades of fabric are used on one panel, the entire panel must be priced at highest grade.
- An aluminum low profile top cap is included.
- Stackability: Evolve panels can be increased in height in 6”H, 12”H, 18”H or 24”H increments. See Extension Module (pages 82-90) for part numbers.

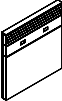
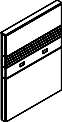
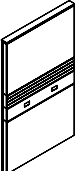
	DESCRIPTION	PRODUCT CODE	LIST PRICE		DIMENSIONS/INCHES		
			Gr1	Gr2	H	W	D
	Frameless Slatwall Beltline Powered Light Panel - Double Sided Only- 42” High	EVPBLSFA4224	333	346	42	24	2 7/8
		EVPBLSFA4230	387	402	42	30	2 7/8
		EVPBLSFA4236	452	470	42	36	2 7/8
		EVPBLSFA4242	507	528	42	42	2 7/8
		EVPBLSFA4248	561	585	42	48	2 7/8
		EVPBLSFA4254	618	644	42	54	2 7/8
		EVPBLSFA4260	671	699	42	60	2 7/8
	Frameless Slatwall Beltline Powered Light Panel - Double Sided Only- 54” High	EVPBLSFA5424	410	430	54	24	2 7/8
		EVPBLSFA5430	448	500	54	30	2 7/8
		EVPBLSFA5436	535	592	54	36	2 7/8
		EVPBLSFA5442	632	663	54	42	2 7/8
		EVPBLSFA5448	696	732	54	48	2 7/8
		EVPBLSFA5454	756	795	54	54	2 7/8
		EVPBLSFA5460	825	868	54	60	2 7/8
	Frameless Slatwall Beltline Powered Light Panel - Double Sided Only - 66” High	EVPBLSFA6624	456	480	66	24	2 7/8
		EVPBLSFA6630	527	559	66	30	2 7/8
		EVPBLSFA6636	612	648	66	36	2 7/8
		EVPBLSFA6642	685	728	66	42	2 7/8
		EVPBLSFA6648	757	804	66	48	2 7/8
		EVPBLSFA6654	830	881	66	54	2 7/8
		EVPBLSFA6660	903	960	66	60	2 7/8



**EVPBCSFA - FRAMELESS SLATWALL BELTLINE POWERED CHIMNEY PANEL - DOUBLE SIDED ONLY**

- Frameless Slatwall Beltline Powered Chimney Panel incorporates fabric modules with a single 6”H slatwall module above a power beltline raceway, into a solid steel frame.
- Slatwall module has slatwall on both sides only, and is not available Single Sided.
- Slatwall is made of aluminum.
- Slatwall is not encompassed within a frame.
- A Chimney Panel is required to run electric and data from the base to belt.
- Separate electric harness required to go from base to belt (see EVE8CPCP).
- 6”H power beltline raceway, to accommodate electrical, is metal with knockouts on both sides.
- Beltline Connectors must be used in conjunction with beltline panels.
- Accessories can be used on slatwall modules. Please see accessory section for additional details.
- Opposite sides of each panel may have a different fabric within the same grade at no upcharge.
- If different grades of fabric are used on one panel, the entire panel must be priced at highest grade.
- An aluminum low profile top cap is included.
- Stackability: Evolve panels can be increased in height in 6”H, 12”H, 18”H or 24”H increments. See Extension Module (pages 82-90) for part numbers.

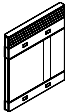
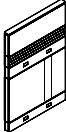
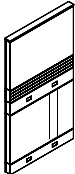
	DESCRIPTION	PRODUCT CODE	LIST PRICE		DIMENSIONS/INCHES		
			Gr1	Gr2	H	W	D
	Frameless Slatwall Beltline Powered -	EVPBCSFA4236	525	543	42	36	2 7/8
	Chimney Panel - Double Sided Only - 42” High	EVPBCSFA4242	584	606	42	42	2 7/8
	Frameless Slatwall Beltline Powered -	EVPBCSFA5436	658	685	54	36	2 7/8
	Chimney Panel - Double Sided Only - 54” High	EVPBCSFA5442	730	761	54	42	2 7/8
	Frameless Slatwall Beltline Powered -	EVPBCSFA6636	712	748	66	36	2 7/8
	Chimney Panel - Double Sided Only - 66” High	EVPBCSFA6642	792	834	66	42	2 7/8

**EVE8CPCP - CHIMNEY PANEL JUMPER CABLE KIT**

- Contains two (2) 17” flexible harnesses and one (1) “I” connector.
- Used to connect electric from the base to the beltline raceway in Beltline Powered Chimney panel.
- Must use in conjunction with base power distribution harness and beltline power distribution harness (sold separately)

	DESCRIPTION	PRODUCT CODE	LIST PRICE	DIMENSIONS/INCHES		
				H	W	D

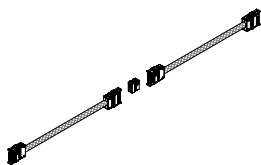



Chimney Panel Jumper Cable Kit	EVE8CPCP	229
--------------------------------	----------	-----





**EVPF1W - WRITE BOARD PANEL - SINGLE SIDED**

- Write Board Panel incorporates fabric modules with a single 24”H top position write board module, into a solid steel frame.
- Use erasable writeboard markers only.
- Fabric covered modules are tackable and acoustical.
- Opposite sides of each panel may have a different fabric within the same grade at no upcharge.
- If different grades of fabric are used on one panel, the entire panel must be priced at highest grade.
- An aluminum low profile top cap is included.
- Stackability: Evolve panels can be increased in height in 6”H, 12”H, 18”H or 24”H increments. See Extension Module (pages 82-90) for part numbers.

	DESCRIPTION	PRODUCT CODE	LIST PRICE		DIMENSIONS/INCHES		
			Gr1	Gr2	H	W	D
	Write Board Panel - Single Sided - 54” High	EVPF1W5418	344	354	54	18	2 7/8
		EVPF1W5424	426	446	54	24	2 7/8
		EVPF1W5430	514	538	54	30	2 7/8
		EVPF1W5436	570	597	54	36	2 7/8
		EVPF1W5442	642	674	54	42	2 7/8
		EVPF1W5448	723	759	54	48	2 7/8
		EVPF1W5454	804	830	54	54	2 7/8
		EVPF1W5460	886	929	54	60	2 7/8
	Write Board Panel - Single Sided - 66” High	EVPF1W6618	437	453	66	18	2 7/8
		EVPF1W6624	538	563	66	24	2 7/8
		EVPF1W6630	639	668	66	30	2 7/8
		EVPF1W6636	711	748	66	36	2 7/8
		EVPF1W6642	805	848	66	42	2 7/8
		EVPF1W6648	899	947	66	48	2 7/8
		EVPF1W6654	999	1054	66	54	2 7/8
		EVPF1W6660	1103	1162	66	60	2 7/8

**EVPLF1W - WRITE BOARD LIGHT PANEL - SINGLE SIDED**



- Write Board Panel incorporates fabric modules with a single 24”H top position write board module, into a solid steel frame.
- Use erasable writeboard markers only.
- Fabric covered modules are tackable and acoustical.
- Opposite sides of each panel may have a different fabric within the same grade at no upcharge.
- If different grades of fabric are used on one panel, the entire panel must be priced at highest grade.
- Light panel connectors must be used for Light Panels.
- There is no base raceway in Light Panels to accommodate electrical.
- An aluminum low profile top cap is included.
- Stackability: Evolve panels can be increased in height in 6”H, 12”H, 18”H or 24”H increments. See Extension Module (pages 82-90) for part numbers.

	DESCRIPTION	PRODUCT CODE	LIST PRICE		DIMENSIONS/INCHES		
			Gr1	Gr2	H	W	D
	Write Board Light Panel - Single Sided - 54” High	EVPLF1W5418	333	344	54	18	2 7/8
		EVPLF1W5424	413	433	54	18	2 7/8
		EVPLF1W5430	499	521	54	18	2 7/8
		EVPLF1W5436	553	579	54	18	2 7/8
		EVPLF1W5442	622	653	54	18	2 7/8
		EVPLF1W5448	701	736	54	18	2 7/8
		EVPLF1W5454	781	805	54	18	2 7/8
		EVPLF1W5460	859	901	54	18	2 7/8
	Write Board Light Panel - Single Sided - 66” High	EVPLF1W6618	424	439	66	18	2 7/8
		EVPLF1W6624	521	546	66	24	2 7/8
		EVPLF1W6630	619	648	66	30	2 7/8
		EVPLF1W6636	689	725	66	36	2 7/8
		EVPLF1W6642	782	822	66	42	2 7/8
		EVPLF1W6648	871	918	66	48	2 7/8
		EVPLF1W6654	969	1022	66	54	2 7/8
		EVPLF1W6660	1069	1127	66	60	2 7/8





**EVPF2W - WRITE BOARD PANEL - DOUBLE SIDED**

- Write Board Panel incorporates fabric modules with a single 24”H top position write board module, into a solid steel frame.
- Use erasable writeboard markers only.
- Opposite sides of each panel may have a different fabric within the same grade at no upcharge.
- If different grades of fabric are used on one panel, the entire panel must be priced at highest grade.
- An aluminum low profile top cap is included.
- Stackability: Evolve panels can be increased in height in 6”H, 12”H, 18”H or 24”H increments. See Extension Module (pages 82-90) for part numbers.

	DESCRIPTION	PRODUCT CODE	LIST PRICE		DIMENSIONS/INCHES		
			Gr1	Gr2	H	W	D
	Write Board Panel - Double Sided - 54” High	EVPF2W5418	371	381	54	18	2 7/8
		EVPF2W5424	466	477	54	24	2 7/8
		EVPF2W5430	580	595	54	30	2 7/8
		EVPF2W5436	628	648	54	36	2 7/8
		EVPF2W5442	712	733	54	42	2 7/8
		EVPF2W5448	833	857	54	48	2 7/8
		EVPF2W5454	926	952	54	54	2 7/8
	Write Board Panel - Double Sided - 66” High	EVPF2W6618	462	477	66	18	2 7/8
		EVPF2W6624	576	595	66	24	2 7/8
		EVPF2W6630	705	729	66	30	2 7/8
		EVPF2W6636	771	799	66	36	2 7/8
		EVPF2W6642	874	906	66	42	2 7/8
		EVPF2W6648	1006	1040	66	48	2 7/8
		EVPF2W6654	1122	1162	66	54	2 7/8
		EVPF2W6660	1237	1281	66	60	2 7/8

**EVPLF2W - WRITE BOARD LIGHT PANEL - DOUBLE SIDED**

- Write Board Light Panel incorporates fabric modules with a single 24”H top position write board module, into a solid steel frame.
- Use erasable writeboard markers only.
- There is no base raceway in Light Panels to accommodate electrical.
- Light Panel Connectors must be used in conjunction with Light Panels.
- Opposite sides of each panel may have a different fabric within the same grade at no upcharge.
- If different grades of fabric are used on one panel, the entire panel must be priced at highest grade.
- An aluminum low profile top cap is included.
- Stackability: Evolve panels can be increased in height in 6”H, 12”H, 18”H or 24”H increments. See Extension Module (pages 82-90) for part numbers.

	DESCRIPTION	PRODUCT CODE	LIST PRICE		DIMENSIONS/INCHES		
			Gr1	Gr2	H	W	D
	Write Board Light Panel - Double Sided - 54” High	EVPLF2W5418	361	369	54	18	2 7/8
		EVPLF2W5424	451	462	54	18	2 7/8
		EVPLF2W5430	562	578	54	18	2 7/8
		EVPLF2W5436	610	628	54	18	2 7/8
		EVPLF2W5442	690	712	54	18	2 7/8
		EVPLF2W5448	808	830	54	18	2 7/8
		EVPLF2W5454	898	924	54	18	2 7/8
	Write Board Light Panel - Double Sided - 66” High	EVPLF2W6618	449	462	66	18	2 7/8
		EVPLF2W6624	558	578	66	24	2 7/8
		EVPLF2W6630	683	708	66	30	2 7/8
		EVPLF2W6636	749	776	66	36	2 7/8
		EVPLF2W6642	849	880	66	42	2 7/8
		EVPLF2W6648	975	1009	66	48	2 7/8
		EVPLF2W6654	1088	1127	66	54	2 7/8
		EVPLF2W6660	1166	1206	66	60	2 7/8

**EVPH1S - LAMINATE PANEL - SINGLE SIDED**

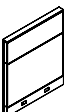
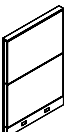
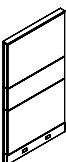

- Laminate Panel incorporates single sided laminate modules, into a solid steel frame.
- Opposite side is fabric covered.
- Laminate faces on all modules provide durable, washable surfaces on Single Sided of the panel.
- Available in high pressure laminate only.
- If wood grain is selected, grain runs horizontally.
- If different grades of fabric are used on one panel, the entire panel must be priced at highest grade.
- An aluminum low profile top cap is included.
- Stackability: Evolve panels can be increased in height in 6”H, 12”H, 18”H or 24”H increments. See Extension Module (pages 82-90) for part numbers.

	DESCRIPTION	PRODUCT CODE	LIST PRICE		DIMENSIONS/INCHES		
			Gr1	Gr2	H	W	D
	Laminate Panel - Single Sided - 30” High	EVPH1S3018	283	288	30	18	2 7/8
		EVPH1S3024	339	346	30	24	2 7/8
		EVPH1S3030	393	402	30	30	2 7/8
		EVPH1S3036	449	459	30	36	2 7/8
		EVPH1S3042	510	519	30	42	2 7/8
		EVPH1S3048	555	565	30	48	2 7/8
		EVPH1S3054	612	626	30	54	2 7/8
		EVPH1S3060	672	686	30	60	2 7/8
	Laminate Panel - Single Sided - 42” High	EVPH1S4218	337	344	42	18	2 7/8
		EVPH1S4224	401	411	42	24	2 7/8
		EVPH1S4230	470	482	42	30	2 7/8
		EVPH1S4236	538	553	42	36	2 7/8
		EVPH1S4242	610	626	42	42	2 7/8
		EVPH1S4248	664	682	42	48	2 7/8
		EVPH1S4254	736	757	42	54	2 7/8
		EVPH1S4260	808	830	42	60	2 7/8
	Laminate Panel - Single Sided - 54” High	EVPH1S5418	394	402	54	18	2 7/8
		EVPH1S5424	476	490	54	24	2 7/8
		EVPH1S5430	558	574	54	30	2 7/8
		EVPH1S5436	640	657	54	36	2 7/8
		EVPH1S5442	725	747	54	42	2 7/8
		EVPH1S5448	791	815	54	48	2 7/8
		EVPH1S5454	880	905	54	54	2 7/8
		EVPH1S5460	967	996	54	60	2 7/8
	Laminate Panel - Single Sided - 66” High	EVPH1S6618	489	502	66	18	2 7/8
		EVPH1S6624	588	606	66	24	2 7/8
		EVPH1S6630	688	709	66	30	2 7/8
		EVPH1S6636	793	817	66	36	2 7/8
		EVPH1S6642	902	928	66	42	2 7/8
		EVPH1S6648	982	1011	66	48	2 7/8
		EVPH1S6654	1093	1126	66	54	2 7/8
		EVPH1S6660	1203	1239	66	60	2 7/8





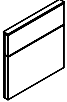
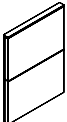

**EVPLH1S - LAMINATE LIGHT PANEL - SINGLE SIDED**

- Laminate Panel incorporates single sided laminate modules, into a solid steel frame.
- Opposite side is fabric covered.
- Laminate faces on all modules provide durable, washable surfaces on Single Sided of the panel.
- Available in high pressure laminate only
- If wood grain is selected, grain runs horizontally.
- There is no base raceway in Light Panels to accommodate electrical.
- Light Panel Connectors must be used in conjunction with Light Panels.
- If different grades of fabric are used on one panel, the entire panel must be priced at highest grade.
- An aluminum low profile top cap is included.
- Stackability: Evolve panels can be increased in height in 6”H, 12”H, 18”H or 24”H increments. See Extension Module (pages 82-90) for part numbers.

	DESCRIPTION	PRODUCT CODE	LIST PRICE		DIMENSIONS/INCHES		
			Gr1	Gr2	H	W	D
	Laminate Light Panel - Single Sided - 30" High	EVPLH1S3018	275	280	30	18	2 7/8
		EVPLH1S3024	329	336	30	24	2 7/8
		EVPLH1S3030	382	389	30	30	2 7/8
		EVPLH1S3036	436	446	30	36	2 7/8
		EVPLH1S3042	494	504	30	42	2 7/8
		EVPLH1S3048	539	548	30	48	2 7/8
		EVPLH1S3054	593	608	30	54	2 7/8
		EVPLH1S3060	651	665	30	60	2 7/8
	Laminate Light Panel - Single Sided - 42" High	EVPLH1S4218	327	333	42	18	2 7/8
		EVPLH1S4224	388	399	42	24	2 7/8
		EVPLH1S4230	455	469	42	30	2 7/8
		EVPLH1S4236	521	537	42	36	2 7/8
		EVPLH1S4242	591	608	42	42	2 7/8
		EVPLH1S4248	645	661	42	48	2 7/8
		EVPLH1S4254	715	734	42	54	2 7/8
		EVPLH1S4260	784	805	42	60	2 7/8
	Laminate Light Panel - Single Sided - 54" High	EVPLH1S5418	383	389	54	18	2 7/8
		EVPLH1S5424	461	475	54	24	2 7/8
		EVPLH1S5430	542	556	54	30	2 7/8
		EVPLH1S5436	620	639	54	36	2 7/8
		EVPLH1S5442	703	723	54	42	2 7/8
		EVPLH1S5448	766	790	54	48	2 7/8
		EVPLH1S5454	853	879	54	54	2 7/8
		EVPLH1S5460	937	966	54	60	2 7/8
	Laminate Light Panel - Single Sided - 66" High	EVPLH1S6618	474	487	66	18	2 7/8
		EVPLH1S6624	571	587	66	24	2 7/8
		EVPLH1S6630	667	687	66	30	2 7/8
		EVPLH1S6636	769	792	66	36	2 7/8
		EVPLH1S6642	874	900	66	42	2 7/8
		EVPLH1S6648	953	981	66	48	2 7/8
		EVPLH1S6654	1060	1093	66	54	2 7/8
		EVPLH1S6660	1167	1203	66	60	2 7/8

**EVPH2S - LAMINATE PANEL - DOUBLE SIDED**





- Laminate Panel incorporates double sided laminate modules, into a solid steel frame.
- Laminate faces on all modules provide durable, washable surfaces on Single Sided of the panel.
- Available in high pressure laminate only
- If wood grain is selected, grain runs horizontally.
- If different grades of fabric are used on one panel, the entire panel must be priced at highest grade.
- An aluminum low profile top cap is included.
- Stackability: Evolve panels can be increased in height in 6”H, 12”H, 18”H or 24”H increments. See Extension Module (pages 82-90) for part numbers.

	DESCRIPTION	PRODUCT CODE	LIST PRICE	DIMENSIONS/INCHES		
				H	W	D
	Laminate Panel - Double Sided - 30" High	EVPH2S3018	386	30	18	2 7/8
		EVPH2S3024	386	30	24	2 7/8
		EVPH2S3030	456	30	30	2 7/8
		EVPH2S3036	521	30	36	2 7/8
		EVPH2S3042	593	30	42	2 7/8
		EVPH2S3048	663	30	48	2 7/8
		EVPH2S3054	734	30	54	2 7/8
		EVPH2S3060	793	30	60	2 7/8
	Laminate Panel - Double Sided - 42" High	EVPH2S4218	375	42	18	2 7/8
		EVPH2S4224	456	42	24	2 7/8
		EVPH2S4230	537	42	30	2 7/8
		EVPH2S4236	625	42	36	2 7/8
		EVPH2S4242	712	42	42	2 7/8
		EVPH2S4248	798	42	48	2 7/8
		EVPH2S4254	878	42	54	2 7/8
		EVPH2S4260	954	42	60	2 7/8
	Laminate Panel - Double Sided - 54" High	EVPH2S5418	440	54	18	2 7/8
		EVPH2S5424	539	54	24	2 7/8
		EVPH2S5430	639	54	30	2 7/8
		EVPH2S5436	742	54	36	2 7/8
		EVPH2S5442	848	54	42	2 7/8
		EVPH2S5448	953	54	48	2 7/8
		EVPH2S5454	1050	54	54	2 7/8
		EVPH2S5460	1143	54	60	2 7/8
	Laminate Panel - Double Sided - 66" High	EVPH2S6618	555	66	18	2 7/8
		EVPH2S6624	682	66	24	2 7/8
		EVPH2S6630	808	66	30	2 7/8
		EVPH2S6636	937	66	36	2 7/8
		EVPH2S6642	1073	66	42	2 7/8
		EVPH2S6648	1203	66	48	2 7/8
		EVPH2S6654	1328	66	54	2 7/8
		EVPH2S6660	1451	66	60	2 7/8



**EVPLH2S - LAMINATE LIGHT PANEL - DOUBLE SIDED**

- Laminate Panel incorporates double sided laminate modules, into a solid steel frame.
- Laminate faces on all modules provide durable, washable surfaces on Single Sided of the panel.
- Available in high pressure laminate only
- If wood grain is selected, grain runs horizontally.
- There is no base raceway in Light Panels to accommodate electrical.
- Light Panel Connectors must be used in conjunction with Light Panels.
- If different grades of fabric are used on one panel, the entire panel must be priced at highest grade.
- An aluminum low profile top cap is included.
- Stackability: Evolve panels can be increased in height in 6”H, 12”H, 18”H or 24”H increments. See Extension Module (pages 82-90) for part numbers.

	DESCRIPTION	PRODUCT CODE	LIST PRICE	DIMENSIONS/INCHES		
				H	W	D
	Laminate Light Panel - Double Sided - 30" High	EVPLH2S3018	374	30	18	2 7/8
		EVPLH2S3024	374	30	24	2 7/8
		EVPLH2S3030	442	30	30	2 7/8
		EVPLH2S3036	506	30	36	2 7/8
		EVPLH2S3042	577	30	42	2 7/8
		EVPLH2S3048	644	30	48	2 7/8
		EVPLH2S3054	713	30	54	2 7/8
		EVPLH2S3060	769	30	60	2 7/8
	Laminate Light Panel - Double Sided - 42" High	EVPLH2S4218	365	42	18	2 7/8
		EVPLH2S4224	442	42	24	2 7/8
		EVPLH2S4230	520	42	30	2 7/8
		EVPLH2S4236	607	42	36	2 7/8
		EVPLH2S4242	690	42	42	2 7/8
		EVPLH2S4248	775	42	48	2 7/8
		EVPLH2S4254	851	42	54	2 7/8
		EVPLH2S4260	926	42	60	2 7/8
	Laminate Light Panel - Double Sided - 54" High	EVPLH2S5418	427	54	18	2 7/8
		EVPLH2S5424	522	54	24	2 7/8
		EVPLH2S5430	619	54	30	2 7/8
		EVPLH2S5436	719	54	36	2 7/8
		EVPLH2S5442	822	54	42	2 7/8
		EVPLH2S5448	925	54	48	2 7/8
		EVPLH2S5454	1018	54	54	2 7/8
		EVPLH2S5460	1108	54	60	2 7/8
	Laminate Light Panel - Double Sided - 66" High	EVPLH2S6618	474	66	18	2 7/8
		EVPLH2S6624	661	66	24	2 7/8
		EVPLH2S6630	784	66	30	2 7/8
		EVPLH2S6636	909	66	36	2 7/8
		EVPLH2S6642	1040	66	42	2 7/8
		EVPLH2S6648	1167	66	48	2 7/8
		EVPLH2S6654	1289	66	54	2 7/8
		EVPLH2S6660	1408	66	60	2 7/8



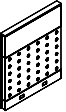
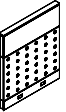
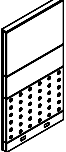

**EVPPAF - AIRFLOW PANEL**

- Airflow Panel incorporates bottom 24”H airflow module with individual fabric modules, within a steel frame.
- The 24”H Metal airflow module is positioned in the base section to provide air circulation.
- Opposite sides of each panel may have a different fabric within the same grade at no upcharge.
- If different grades of fabric are used on one panel, the entire panel must be priced at highest grade.
- An aluminum low profile top cap is included.
- Stackability: Evolve panels can be increased in height in 6”H, 12”H, 18”H or 24”H increments. See Extension Module (pages 82-90) for part numbers.

	DESCRIPTION	PRODUCT CODE	LIST PRICE		DIMENSIONS/INCHES		
			Gr1	Gr2	H	W	D
	Airflow Panel - 30” High	EVPPAF3024	324		30	24	2 7/8
		EVPPAF3030	385		30	30	2 7/8
		EVPPAF3036	427		30	36	2 7/8
		EVPPAF3042	474		30	42	2 7/8
		EVPPAF3048	535		30	48	2 7/8
		EVPPAF3054	614		30	54	2 7/8
		EVPPAF3060	693		30	60	2 7/8
	Airflow Panel - 42” High	EVPPAF4224	413	419	42	24	2 7/8
		EVPPAF4230	489	497	42	30	2 7/8
		EVPPAF4236	545	555	42	36	2 7/8
		EVPPAF4242	605	615	42	42	2 7/8
		EVPPAF4248	684	695	42	48	2 7/8
		EVPPAF4254	779	792	42	54	2 7/8
		EVPPAF4260	791	805	42	60	2 7/8
	Airflow Panel - 54” High	EVPPAF5424	464	477	54	24	2 7/8
		EVPPAF5430	534	549	54	30	2 7/8
		EVPPAF5436	598	617	54	36	2 7/8
		EVPPAF5442	667	689	54	42	2 7/8
		EVPPAF5448	749	773	54	48	2 7/8
		EVPPAF5454	872	900	54	54	2 7/8
		EVPPAF5460	951	980	54	60	2 7/8
	Airflow Panel - 66” High	EVPPAF6624	541	560	66	24	2 7/8
		EVPPAF6630	639	662	66	30	2 7/8
		EVPPAF6636	716	744	66	36	2 7/8
		EVPPAF6642	798	829	66	42	2 7/8
		EVPPAF6648	899	934	66	48	2 7/8
		EVPPAF6654	1016	1056	66	54	2 7/8
		EVPPAF6660	1131	1175	66	60	2 7/8

**EVPLFAF - AIRFLOW LIGHT PANEL**



- Airflow Light Panel incorporates bottom 24”H airflow module with individual fabric modules, within a steel frame.
- The 24”H Metal airflow module is positioned in the base section to provide air circulation.
- There is no base raceway in Light Panels to accommodate electrical.
- Light Panel Connectors must be used in conjunction with Light Panels.
- Opposite sides of each panel may have a different fabric within the same grade at no upcharge.
- If different grades of fabric are used on one panel, the entire panel must be priced at highest grade.
- An aluminum low profile top cap is included.
- Stackability: Evolve panels can be increased in height in 6”H, 12”H, 18”H or 24”H increments. See Extension Module listings for part numbers

	DESCRIPTION	PRODUCT CODE	LIST PRICE		DIMENSIONS/INCHES		
			Gr1	Gr2	H	W	D
	Airflow Light Panel - 30” High	EVPLFAF3024	315		30	18	2 7/8
		EVPLFAF3030	373		30	30	2 7/8
		EVPLFAF3036	414		30	36	2 7/8
		EVPLFAF3042	459		30	42	2 7/8
		EVPLFAF3048	518		30	48	2 7/8
		EVPLFAF3054	596		30	54	2 7/8
		EVPLFAF3060	673		30	60	2 7/8
	Airflow Light Panel - 42” High	EVPLFAF4224	402	407	42	18	2 7/8
		EVPLFAF4230	474	483	42	30	2 7/8
		EVPLFAF4236	528	539	42	36	2 7/8
		EVPLFAF4242	586	597	42	42	2 7/8
		EVPLFAF4248	663	675	42	48	2 7/8
		EVPLFAF4254	755	768	42	54	2 7/8
		EVPLFAF4260	766	782	42	60	2 7/8
	Airflow Light Panel - 54” High	EVPLFAF5424	450	462	54	18	2 7/8
		EVPLFAF5430	517	534	54	30	2 7/8
		EVPLFAF5436	580	598	54	36	2 7/8
		EVPLFAF5442	647	668	54	42	2 7/8
		EVPLFAF5448	726	750	54	48	2 7/8
		EVPLFAF5454	847	870	54	54	2 7/8
		EVPLFAF5460	923	951	54	60	2 7/8
	Airflow Light Panel - 66” High	EVPLFAF6624	524	543	66	18	2 7/8
		EVPLFAF6630	619	643	66	30	2 7/8
		EVPLFAF6636	694	721	66	36	2 7/8
		EVPLFAF6642	775	804	66	42	2 7/8
		EVPLFAF6648	871	906	66	48	2 7/8
		EVPLFAF6654	986	1022	66	54	2 7/8
		EVPLFAF6660	1098	1140	30	60	2 7/8



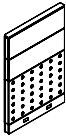

**EVPPPAF - AIRFLOW PREMIUM PANEL**

- Airflow Premium Panel incorporates bottom 24”H airflow module with individual fabric modules, within a steel frame.
- The 24”H Metal airflow module is positioned in the base section to provide air circulation.
- Premium panels incorporate 12”H acoustic modules above 30”H base section.
- Opposite sides of each panel may have a different fabric within the same grade at no upcharge.
- If different grades of fabric are used on one panel, the entire panel must be priced at highest grade.
- An aluminum low profile top cap is included.
- Stackability: Evolve panels can be increased in height in 6”H, 12”H, 18”H or 24”H increments. See Extension Module (pages 82-90) for part numbers.

	DESCRIPTION	PRODUCT CODE	LIST PRICE		DIMENSIONS/INCHES		
			Gr1	Gr2	H	W	D
	Airflow Premium Panel - 54” High	EVPPPAF5424	515	527	54	24	2 7/8
		EVPPPAF5430	590	607	54	30	2 7/8
		EVPPPAF5436	661	679	54	36	2 7/8
		EVPPPAF5442	733	755	54	42	2 7/8
		EVPPPAF5448	831	856	54	48	2 7/8
		EVPPPAF5454	941	968	54	54	2 7/8
		EVPPPAF5460	1052	1080	54	60	2 7/8
	Airflow Premium Panel - 66” High	EVPPPAF6624	591	611	66	24	2 7/8
		EVPPPAF6630	694	718	66	30	2 7/8
		EVPPPAF6636	778	805	66	36	2 7/8
		EVPPPAF6642	863	894	66	42	2 7/8
		EVPPPAF6648	981	1017	66	48	2 7/8
		EVPPPAF6654	1105	1145	66	54	2 7/8
		EVPPPAF6660	1231	1274	66	60	2 7/8

**EVPLPPAF - AIRFLOW PREMIUM LIGHT PANEL**

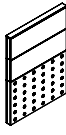
- Airflow Premium Light Panel incorporates bottom 24”H airflow module with individual 12”H fabric modules, within a steel frame.
- The 24”H Metal airflow module is positioned in the base section to provide air circulation.
- Premium panels incorporate 12”H acoustic modules above 30”H base section.
- There is no base raceway in Light Panels to accommodate electrical.
- Light Panel Connectors must be used in conjunction with Light Panels.
- Opposite sides of each panel may have a different fabric within the same grade at no upcharge.
- If different grades of fabric are used on one panel, the entire panel must be priced at highest grade.
- An aluminum low profile top cap is included.
- Stackability: Evolve panels can be increased in height in 6”H, 12”H, 18”H or 24”H increments. See Extension Module (pages 82-90) for part numbers.

	DESCRIPTION	PRODUCT CODE	LIST PRICE		DIMENSIONS/INCHES		
			Gr1	Gr2	H	W	D
	Airflow Premium Light Panel - 54” High	EVPLPPAF5424	500	512	54	18	2 7/8
		EVPLPPAF5430	574	588	54	30	2 7/8
		EVPLPPAF5436	642	658	54	36	2 7/8
		EVPLPPAF5442	712	732	54	42	2 7/8
		EVPLPPAF5448	806	829	54	48	2 7/8
		EVPLPPAF5454	913	936	54	54	2 7/8
		EVPLPPAF5460	1020	1048	54	60	2 7/8
	Airflow Premium Light Panel - 66” High	EVPLPPAF6624	575	592	66	18	2 7/8
		EVPLPPAF6630	674	696	66	30	2 7/8
		EVPLPPAF6636	754	782	66	36	2 7/8
		EVPLPPAF6642	837	867	66	42	2 7/8
		EVPLPPAF6648	952	987	66	48	2 7/8
		EVPLPPAF6654	1072	1108	66	54	2 7/8
		EVPLPPAF6660	1194	1236	66	60	2 7/8



**EVFPMAF - AIRFLOW MIDDLE PREMIUM PANEL**

- Airflow Panel Middle Premium Panel incorporates a 12”H middle position airflow module with fabric modules, within a steel frame.
- Premium panels incorporate 12”H modules above 30”H base section.
- 12”H airflow panel is located at the beltline.
- Opposite sides of each panel may have a different fabric within the same grade at no upcharge.
- If different grades of fabric are used on one panel, the entire panel must be priced at highest grade.
- An aluminum low profile top cap is included.
- Stackability: Evolve panels can be increased in height in 6”H, 12”H, 18”H or 24”H increments. See Extension Module (pages 82-90) for part numbers.

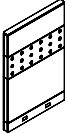
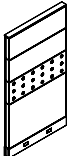
	DESCRIPTION	PRODUCT CODE	LIST PRICE		DIMENSIONS/INCHES		
			Gr1	Gr2	H	W	D
	Airflow Middle Premium Panel - 54” High	EVFPMAF5424	567	589	54	24	2 7/8
		EVFPMAF5430	671	698	54	30	2 7/8
		EVFPMAF5436	762	795	54	36	2 7/8
		EVFPMAF5442	857	893	54	42	2 7/8
		EVFPMAF5448	957	998	54	48	2 7/8
		EVFPMAF5454	1083	1129	54	54	2 7/8
	Airflow Middle Premium Panel - 66” High	EVFPMAF6624	644	668	66	24	2 7/8
		EVFPMAF6630	760	778	66	30	2 7/8
		EVFPMAF6636	864	899	66	36	2 7/8
		EVFPMAF6642	968	1008	66	42	2 7/8
		EVFPMAF6648	1083	1128	66	48	2 7/8
		EVFPMAF6654	1221	1271	66	54	2 7/8
		EVFPMAF6660	1358	1413	66	60	2 7/8



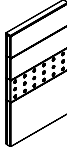

**EVPLPMAF - AIRFLOW MIDDLE PREMIUM LIGHT PANEL**

- Airflow Panel Middle Premium Light Panel incorporates a 12”H middle position airflow module with fabric modules, within a steel frame.
- Premium panels incorporate 12”H modules above 30”H base section.
- 12”H airflow panel is located at the beltline.
- There is no base raceway in Light Panels to accommodate electrical.
- Light Panel Connectors must be used in conjunction with Light Panels.
- Opposite sides of each panel may have a different fabric within the same grade at no upcharge.
- If different grades of fabric are used on one panel, the entire panel must be priced at highest grade.
- An aluminum low profile top cap is included.
- Stackability: Evolve panels can be increased in height in 6”H, 12”H, 18”H or 24”H increments. See Extension Module (pages 82-90) for part numbers.

	DESCRIPTION	PRODUCT CODE	LIST PRICE		DIMENSIONS/INCHES		
			Gr1	Gr2	H	W	D
	Airflow Middle Premium Light Panel - 66” High	EVPLPMAF6624	519	543	66	18	2 7/8
		EVPLPMAF6630	613	636	66	30	2 7/8
		EVPLPMAF6636	698	733	66	36	2 7/8
		EVPLPMAF6642	786	824	66	42	2 7/8
		EVPLPMAF6648	955	1000	66	48	2 7/8
		EVPLPMAF6654	987	1034	66	54	2 7/8
		EVPLPMAF6660	1099	1153	66	60	2 7/8

**EVPM1S - METAL SKIN PANEL - SINGLE SIDED**

- Metal Skin Panel incorporates single sided metal skin modules, into a solid steel frame.
- Opposite side is fabric covered.
- Metal faces on all modules provide durable, washable and magnetic surfaces on Single Sided of the panel.
- If different grades of fabric are used on one panel, the entire panel must be priced at highest grade.
- An aluminum low profile top cap is included.
- Stackability: Evolve panels can be increased in height in 6”H, 12”H, 18”H or 24”H increments. See Extension Module (pages 82-90) for part numbers.

	DESCRIPTION	PRODUCT CODE	LIST PRICE		DIMENSIONS/INCHES		
			Gr1	Gr2	H	W	D
	Metal Skin Panel - Single Sided 30" High	EVPM1S3018	368	373	30	18	2 7/8
		EVPM1S3024	440	447	30	24	2 7/8
		EVPM1S3030	511	518	30	30	2 7/8
		EVPM1S3036	583	592	30	36	2 7/8
		EVPM1S3042	662	673	30	42	2 7/8
		EVPM1S3048	720	731	30	48	2 7/8
		EVPM1S3054	796	809	30	54	2 7/8
		EVPM1S3060	872	887	30	60	2 7/8
	Metal Skin Panel - Single Sided 42" High	EVPM1S4218	437	444	42	18	2 7/8
		EVPM1S4224	519	528	42	24	2 7/8
		EVPM1S4230	610	622	42	30	2 7/8
		EVPM1S4236	698	714	42	36	2 7/8
		EVPM1S4242	793	809	42	42	2 7/8
		EVPM1S4248	862	881	42	48	2 7/8
		EVPM1S4254	957	976	42	54	2 7/8
		EVPM1S4260	1051	1073	42	60	2 7/8
	Metal Skin Panel - Single Sided 54" High	EVPM1S5418	513	522	54	18	2 7/8
		EVPM1S5424	619	631	54	24	2 7/8
		EVPM1S5430	725	740	54	30	2 7/8
		EVPM1S5436	829	849	54	36	2 7/8
		EVPM1S5442	942	964	54	42	2 7/8
		EVPM1S5448	1028	1052	54	48	2 7/8
		EVPM1S5454	1143	1170	54	54	2 7/8
		EVPM1S5460	1257	1285	54	60	2 7/8
	Metal Skin Panel - Single Sided 66" High	EVPM1S6618	634	648	66	18	2 7/8
		EVPM1S6624	764	781	66	24	2 7/8
		EVPM1S6630	893	914	66	30	2 7/8
		EVPM1S6636	1031	1055	66	36	2 7/8
		EVPM1S6642	1172	1198	66	42	2 7/8
		EVPM1S6648	1275	1305	66	48	2 7/8
		EVPM1S6654	1419	1452	66	54	2 7/8
		EVPM1S6660	1564	1601	66	60	2 7/8





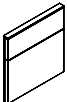
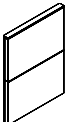
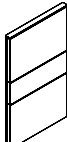

**EVPLM1S - METAL SKIN LIGHT PANEL - SINGLE SIDED**

- Metal Skin Light Panel incorporates single sided metal skin modules, into a solid steel frame.
- Opposite side is fabric covered.
- Metal faces on all modules provide durable, washable and magnetic surfaces on Single Sided of the panel.
- There is no base raceway in Light Panels to accommodate electrical.
- Light Panel Connectors must be used in conjunction with Light Panels.
- If different grades of fabric are used on one panel, the entire panel must be priced at highest grade.
- An aluminum low profile top cap is included.
- Stackability: Evolve panels can be increased in height in 6”H, 12”H, 18”H or 24”H increments. See Extension Module (pages 82-90) for part numbers.

	DESCRIPTION	PRODUCT CODE	LIST PRICE		DIMENSIONS/INCHES		
			Gr1	Gr2	H	W	D
	Metal Skin Light Panel - Single Sided - 30” High	EVPLM1S3018	357	363	30	18	2 7/8
		EVPLM1S3024	427	434	30	24	2 7/8
		EVPLM1S3030	495	503	30	30	2 7/8
		EVPLM1S3036	565	576	30	36	2 7/8
		EVPLM1S3042	643	652	30	42	2 7/8
		EVPLM1S3048	698	710	30	48	2 7/8
		EVPLM1S3054	773	785	30	54	2 7/8
		EVPLM1S3060	847	860	30	60	2 7/8
	Metal Skin Light Panel - Single Sided - 42” High	EVPLM1S4218	424	431	42	18	2 7/8
		EVPLM1S4224	504	513	42	24	2 7/8
		EVPLM1S4230	591	604	42	30	2 7/8
		EVPLM1S4236	678	692	42	36	2 7/8
		EVPLM1S4242	769	785	42	42	2 7/8
		EVPLM1S4248	836	855	42	48	2 7/8
		EVPLM1S4254	928	948	42	54	2 7/8
		EVPLM1S4260	1019	1040	42	60	2 7/8
	Metal Skin Light Panel - Single Sided - 54” High	EVPLM1S5418	497	507	54	18	2 7/8
		EVPLM1S5424	600	612	54	24	2 7/8
		EVPLM1S5430	703	717	54	30	2 7/8
		EVPLM1S5436	804	823	54	36	2 7/8
		EVPLM1S5442	914	934	54	42	2 7/8
		EVPLM1S5448	997	1020	54	48	2 7/8
		EVPLM1S5454	1108	1136	54	54	2 7/8
		EVPLM1S5460	1218	1247	54	60	2 7/8
	Metal Skin Light Panel - Single Sided - 66” High	EVPLM1S6618	615	628	66	18	2 7/8
		EVPLM1S6624	742	757	66	24	2 7/8
		EVPLM1S6630	866	887	66	30	2 7/8
		EVPLM1S6636	999	1023	66	36	2 7/8
		EVPLM1S6642	1137	1163	66	42	2 7/8
		EVPLM1S6648	1237	1267	66	48	2 7/8
		EVPLM1S6654	1377	1409	66	54	2 7/8
		EVPLM1S6660	1517	1553	66	60	2 7/8

**EVPM2S - METAL SKIN PANEL - DOUBLE SIDED**

- Metal Skin Panel incorporates double sided metal skin modules, into a solid steel frame.
- Metal faces on all modules provide durable, washable and magnetic surfaces on Single Sided of the panel.
- If different grades of fabric are used on one panel, the entire panel must be priced at highest grade.
- An aluminum low profile top cap is included.
- Stackability: Evolve panels can be increased in height in 6”H, 12”H, 18”H or 24”H increments. See Extension Module (pages 82-90) for part numbers.

	DESCRIPTION	PRODUCT CODE	LIST PRICE	DIMENSIONS/INCHES		
				H	W	D
	Metal Skin Panel - Double Sided - 30” High	EVPM2S3018	541	30	18	2 7/8
		EVPM2S3024	541	30	24	2 7/8
		EVPM2S3030	637	30	30	2 7/8
		EVPM2S3036	730	30	36	2 7/8
		EVPM2S3042	730	30	42	2 7/8
		EVPM2S3048	829	30	48	2 7/8
		EVPM2S3054	927	30	54	2 7/8
	EVPM2S3060	1109	30	60	2 7/8	
	Metal Skin Panel - Double Sided - 42” High	EVPM2S4218	524	42	18	2 7/8
		EVPM2S4224	637	42	24	2 7/8
		EVPM2S4230	751	42	30	2 7/8
		EVPM2S4236	874	42	36	2 7/8
		EVPM2S4242	995	42	42	2 7/8
		EVPM2S4248	1117	42	48	2 7/8
		EVPM2S4254	1228	42	54	2 7/8
	EVPM2S4260	1336	42	60	2 7/8	
	Metal Skin Panel - Double Sided - 54” High	EVPM2S5418	615	54	18	2 7/8
		EVPM2S5424	754	54	24	2 7/8
		EVPM2S5430	892	54	30	2 7/8
		EVPM2S5436	1038	54	36	2 7/8
		EVPM2S5442	1187	54	42	2 7/8
		EVPM2S5448	1334	54	48	2 7/8
		EVPM2S5454	1468	54	54	2 7/8
	EVPM2S5460	1600	54	60	2 7/8	
	Metal Skin Panel - Double Sided - 66” High	EVPM2S6618	776	66	18	2 7/8
		EVPM2S6624	954	66	24	2 7/8
		EVPM2S6630	1130	66	30	2 7/8
		EVPM2S6636	1312	66	36	2 7/8
		EVPM2S6642	1501	66	42	2 7/8
		EVPM2S6648	1684	66	48	2 7/8
		EVPM2S6654	1858	66	54	2 7/8
	EVPM2S6660	2032	66	60	2 7/8	



**EVPLM2S - METAL SKIN LIGHT PANEL - DOUBLE SIDED**

- Metal Skin Light Panel incorporates double sided metal skin modules, into a solid steel frame.
- Metal faces on all modules provide durable, washable and magnetic surfaces on Single Sided of the panel.
- There is no base raceway in Light Panels to accommodate electrical.
- Light Panel Connectors must be used in conjunction with Light Panels.
- If different grades of fabric are used on one panel, the entire panel must be priced at highest grade.
- An aluminum low profile top cap is included.
- Stackability: Evolve panels can be increased in height in 6”H, 12”H, 18”H or 24”H increments. See Extension Module (pages 82-90) for part numbers.

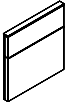
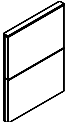
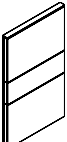
	DESCRIPTION	PRODUCT CODE	LIST PRICE	DIMENSIONS/INCHES		
				H	W	D
	Metal Skin Light Panel - Double Sided - 30" High	EVPLM2S3018	524	30	18	2 7/8
		EVPLM2S3024	524	30	24	2 7/8
		EVPLM2S3030	618	30	30	2 7/8
		EVPLM2S3036	709	30	36	2 7/8
		EVPLM2S3042	709	30	42	2 7/8
		EVPLM2S3048	804	30	48	2 7/8
		EVPLM2S3054	899	30	54	2 7/8
		EVPLM2S3060	1076	30	60	2 7/8
	Metal Skin Light Panel - Double Sided - 42" High	EVPLM2S4218	509	42	18	2 7/8
		EVPLM2S4224	618	42	24	2 7/8
		EVPLM2S4230	728	42	30	2 7/8
		EVPLM2S4236	849	42	36	2 7/8
		EVPLM2S4242	965	42	42	2 7/8
		EVPLM2S4248	1083	42	48	2 7/8
		EVPLM2S4254	1191	42	54	2 7/8
		EVPLM2S4260	1296	42	60	2 7/8
	Metal Skin Light Panel - Double Sided - 54" High	EVPLM2S5418	597	54	18	2 7/8
		EVPLM2S5424	731	54	24	2 7/8
		EVPLM2S5430	865	54	30	2 7/8
		EVPLM2S5436	1007	54	36	2 7/8
		EVPLM2S5442	1151	54	42	2 7/8
		EVPLM2S5448	1294	54	48	2 7/8
		EVPLM2S5454	1423	54	54	2 7/8
		EVPLM2S5460	1552	54	60	2 7/8
	Metal Skin Light Panel - Double Sided - 66" High	EVPLM2S6618	752	66	18	2 7/8
		EVPLM2S6624	926	66	24	2 7/8
		EVPLM2S6630	1097	66	30	2 7/8
		EVPLM2S6636	1273	66	36	2 7/8
		EVPLM2S6642	1455	66	42	2 7/8
		EVPLM2S6648	1634	66	48	2 7/8
		EVPLM2S6654	1801	66	54	2 7/8
		EVPLM2S6660	1990	66	60	2 7/8

**EVPFOL - OPEN BOTTOM PANEL**

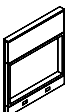
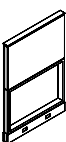
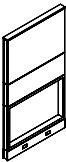

- Open Bottom Panel incorporates bottom 24”H open module with individual fabric modules, within a steel frame.
- The 24”H open bottom module in the base section is to provide air circulation and access to electrical or data.
- Opposite sides of each panel may have a different fabric within the same grade at no upcharge.
- If different grades of fabric are used on one panel, the entire panel must be priced at highest grade.
- An aluminum low profile top cap is included.
- Stackability: Evolve panels can be increased in height in 6”H, 12”H, 18”H or 24”H increments. See Extension Module (pages 82-90) for part numbers.

	DESCRIPTION	PRODUCT CODE	LIST PRICE		DIMENSIONS/INCHES		
			Gr1	Gr2	H	W	D
	Open Bottom Panel - 30" High	EVPFOL3018	186		30	18	2 7/8
		EVPFOL3024	211		30	24	2 7/8
		EVPFOL3030	239		30	30	2 7/8
		EVPFOL3036	263		30	36	2 7/8
		EVPFOL3042	288		30	42	2 7/8
		EVPFOL3048	312		30	48	2 7/8
		EVPFOL3054	338		30	54	2 7/8
EVPFOL3060	362		30	60	2 7/8		
	Open Bottom Panel - 42" High	EVPFOL4218	278	282	42	18	2 7/8
		EVPFOL4224	320	327	42	24	2 7/8
		EVPFOL4230	362	370	42	30	2 7/8
		EVPFOL4236	406	416	42	36	2 7/8
		EVPFOL4242	450	461	42	42	2 7/8
		EVPFOL4248	485	496	42	48	2 7/8
		EVPFOL4254	534	545	42	54	2 7/8
EVPFOL4260	579	592	42	60	2 7/8		
	Open Bottom Panel - 54" High	EVPFOL5418	314	324	54	18	2 7/8
		EVPFOL5424	358	372	54	24	2 7/8
		EVPFOL5430	411	425	54	30	2 7/8
		EVPFOL5436	460	480	54	36	2 7/8
		EVPFOL5442	512	534	54	42	2 7/8
		EVPFOL5448	555	579	54	48	2 7/8
		EVPFOL5454	608	633	54	54	2 7/8
EVPFOL5460	658	689	54	60	2 7/8		
	Open Bottom Panel - 66" High	EVPFOL6618	409	424	66	18	2 7/8
		EVPFOL6624	470	490	66	24	2 7/8
		EVPFOL6630	537	560	66	30	2 7/8
		EVPFOL6636	603	629	66	36	2 7/8
		EVPFOL6642	677	710	66	42	2 7/8
		EVPFOL6648	726	761	66	48	2 7/8
		EVPFOL6654	801	840	66	54	2 7/8
EVPFOL6660	874	920	66	60	2 7/8		



**EVPLFOL - OPEN BOTTOM LIGHT PANEL**

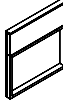
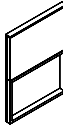

- Open Bottom Light Panel incorporates bottom 24”H open module with individual fabric modules, within a steel frame.
- The 24”H open bottom module in the base section is to provide air circulation and access to electrical or data.
- There is no base raceway in Light Panels to accommodate electrical.
- Light Panel Connectors must be used in conjunction with Light Panels.
- Opposite sides of each panel may have a different fabric within the same grade at no upcharge.
- If different grades of fabric are used on one panel, the entire panel must be priced at highest grade.
- An aluminum low profile top cap is included.
- Stackability: Evolve panels can be increased in height in 6”H, 12”H, 18”H or 24”H increments. See Extension Module (pages 82-90) for part numbers.

	DESCRIPTION	PRODUCT CODE	LIST PRICE		DIMENSIONS/INCHES		
			Gr1	Gr2	H	W	D
	Open Bottom Light Panel - 30” High	EVPLFOL3018	180		30	18	2 7/8
		EVPLFOL3024	204		30	24	2 7/8
		EVPLFOL3030	232		30	30	2 7/8
		EVPLFOL3036	255		30	36	2 7/8
		EVPLFOL3042	280		30	42	2 7/8
		EVPLFOL3048	299		30	48	2 7/8
		EVPLFOL3054	328		30	54	2 7/8
		EVPLFOL3060	350		30	60	2 7/8
	Open Bottom Light Panel - 42” High	EVPLFOL4218	269	274	42	18	2 7/8
		EVPLFOL4224	310	317	42	24	2 7/8
		EVPLFOL4230	350	359	42	30	2 7/8
		EVPLFOL4236	393	404	42	36	2 7/8
		EVPLFOL4242	437	448	42	42	2 7/8
		EVPLFOL4248	472	481	42	48	2 7/8
		EVPLFOL4254	517	528	42	54	2 7/8
		EVPLFOL4260	561	576	42	60	2 7/8
	Open Bottom Light Panel - 54” High	EVPLFOL5418	301	311	54	18	2 7/8
		EVPLFOL5424	344	357	54	24	2 7/8
		EVPLFOL5430	394	408	54	30	2 7/8
		EVPLFOL5436	442	460	54	36	2 7/8
		EVPLFOL5442	491	512	54	42	2 7/8
		EVPLFOL5448	533	556	54	48	2 7/8
		EVPLFOL5454	584	609	54	54	2 7/8
		EVPLFOL5460	632	662	54	60	2 7/8
	Open Bottom Premium Panel - 66” High	EVPLFOL6618	392	407	60	18	2 7/8
		EVPLFOL6624	451	471	60	24	2 7/8
		EVPLFOL6630	515	538	60	30	2 7/8
		EVPLFOL6636	579	605	60	36	2 7/8
		EVPLFOL6642	650	682	60	42	2 7/8
		EVPLFOL6648	696	731	60	48	2 7/8
		EVPLFOL6654	769	806	60	54	2 7/8
		EVPLFOL6660	840	883	60	60	2 7/8



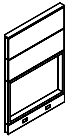

**EVFPOL - OPEN BOTTOM PREMIUM PANEL**

- Open Bottom Premium Panel incorporates bottom 24”H open module with individual fabric modules, within a steel frame.
- The 24”H open bottom module in the base section is to provide air circulation and access to electrical or data.
- Premium panels incorporate 12”H fabric modules above 30”H base section.
- Opposite sides of each panel may have a different fabric within the same grade at no upcharge.
- If different grades of fabric are used on one panel, the entire panel must be priced at highest grade.
- An aluminum low profile top cap is included.
- Stackability: Evolve panels can be increased in height in 6”H, 12”H, 18”H or 24”H increments. See Extension Module (pages 82-90) for part numbers.

	DESCRIPTION	PRODUCT CODE	LIST PRICE		DIMENSIONS/INCHES		
			Gr1	Gr2	H	W	D
	Open Bottom Premium Panel - 54” High	EVFPOL5418	371	381	54	18	2 7/8
		EVFPOL5424	426	440	54	24	2 7/8
		EVFPOL5430	487	502	54	30	2 7/8
		EVFPOL5436	547	565	54	36	2 7/8
		EVFPOL5442	615	636	54	42	2 7/8
		EVFPOL5448	661	685	54	48	2 7/8
		EVFPOL5454	727	754	54	54	2 7/8
		EVFPOL5460	797	825	54	60	2 7/8
	Open Bottom Premium Panel - 66” High	EVFPOL6618	466	481	66	18	2 7/8
		EVFPOL6624	538	558	66	24	2 7/8
		EVFPOL6630	611	634	66	30	2 7/8
		EVFPOL6636	690	718	66	36	2 7/8
		EVFPOL6642	779	810	66	42	2 7/8
		EVFPOL6648	834	870	66	48	2 7/8
		EVFPOL6654	925	965	66	54	2 7/8
		EVFPOL6660	1015	1059	66	60	2 7/8

**EVPLPOL - OPEN BOTTOM PREMIUM LIGHT PANEL**

- Open Bottom Premium Light Panel incorporates bottom 24”H open module with individual fabric modules, within a steel frame.
- The 24”H open bottom module in the base section is to provide air circulation and access to electrical or data.
- Premium panels incorporate 12”H fabric modules above 30”H base section.
- There is no base raceway in Light Panels to accommodate electrical.
- Light Panel Connectors must be used in conjunction with Light Panels.
- Opposite sides of each panel may have a different fabric within the same grade at no upcharge.
- If different grades of fabric are used on one panel, the entire panel must be priced at highest grade.
- An aluminum low profile top cap is included.
- Stackability: Evolve panels can be increased in height in 6”H, 12”H, 18”H or 24”H increments. See Extension Module (pages 82-90) for part numbers.

	DESCRIPTION	PRODUCT CODE	LIST PRICE		DIMENSIONS/INCHES		
			Gr1	Gr2	H	W	D
	Open Bottom Premium Light Panel - 54” High	EVPLPOL5418	355	366	54	18	2 7/8
		EVPLPOL5424	409	423	54	24	2 7/8
		EVPLPOL5430	468	481	54	30	2 7/8
		EVPLPOL5436	525	543	54	36	2 7/8
		EVPLPOL5442	590	610	54	42	2 7/8
		EVPLPOL5448	634	657	54	48	2 7/8
		EVPLPOL5454	697	723	54	54	2 7/8
		EVPLPOL5460	765	792	54	60	2 7/8
	Open Bottom Premium Light Panel - 66” High	EVPLPOL6618	447	461	60	18	2 7/8
		EVPLPOL6624	516	536	60	24	2 7/8
		EVPLPOL6630	586	610	60	30	2 7/8
		EVPLPOL6636	662	689	60	36	2 7/8
		EVPLPOL6642	748	778	60	42	2 7/8
		EVPLPOL6648	800	836	60	48	2 7/8
		EVPLPOL6654	888	926	60	54	2 7/8
		EVPLPOL6660	973	1017	60	60	2 7/8



**EVVFO - OPEN MIDDLE PANEL - 12”H OPENING**

- Open Middle Panel incorporates a 12”H middle position open module with fabric modules, within a steel frame.
- Open Middle Panel Incorporates a 12”H opening above 30”H base module to provide pass-through convenience.
- Opposite sides of each panel may have a different fabric within the same grade at no upcharge.
- If different grades of fabric are used on one panel, the entire panel must be priced at highest grade.
- An aluminum low profile top cap is included.
- Stackability: Evolve panels can be increased in height in 6”H, 12”H, 18”H or 24”H increments. See Extension Module (pages 82-90) for part numbers.

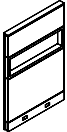
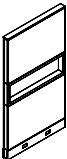
	DESCRIPTION	PRODUCT CODE	LIST PRICE		DIMENSIONS/INCHES		
			Gr1	Gr2	H	W	D
	Open Middle Panel - 12”H Opening - 54” High	EVVFO5418	376	392	54	18	2 7/8
		EVVFO5424	438	458	54	24	2 7/8
		EVVFO5430	505	528	54	30	2 7/8
		EVVFO5436	574	602	54	36	2 7/8
		EVVFO5442	647	678	54	42	2 7/8
		EVVFO5448	697	733	54	48	2 7/8
		EVVFO5454	773	812	54	54	2 7/8
		EVVFO5460	847	891	54	60	2 7/8
	Open Middle Panel - 12”H Opening - 66” High	EVVFO6618	415	436	66	18	2 7/8
		EVVFO6624	480	506	66	24	2 7/8
		EVVFO6630	553	583	66	30	2 7/8
		EVVFO6636	628	665	66	36	2 7/8
		EVVFO6642	708	749	66	42	2 7/8
		EVVFO6648	763	812	66	48	2 7/8
		EVVFO6654	848	900	66	54	2 7/8
		EVVFO6660	926	986	66	60	2 7/8

**EVPLFO - OPEN MIDDLE LIGHT PANEL - 12”H OPENING**

- Open Middle Light Panel incorporates a 12”H middle position open module with fabric modules, within a steel frame.
- Open Middle Light Panel Incorporates a 12”H opening above 30”H base module to provide pass-through convenience.
- There is no base raceway in Light Panels to accommodate electrical.
- Light Panel Connectors must be used in conjunction with Light Panels.
- Opposite sides of each panel may have a different fabric within the same grade at no upcharge.
- If different grades of fabric are used on one panel, the entire panel must be priced at highest grade.
- An aluminum low profile top cap is included.
- Stackability: Evolve panels can be increased in height in 6”H, 12”H, 18”H or 24”H increments. See Extension Module (pages 82-90) for part numbers.

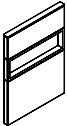
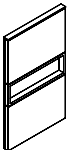
	DESCRIPTION	PRODUCT CODE	LIST PRICE		DIMENSIONS/INCHES		
			Gr1	Gr2	H	W	D
	Open Middle Light Panel - 12”H Opening - 54” High	EVPLFO5418	358	373	54	18	2 7/8
		EVPLFO5424	416	436	54	24	2 7/8
		EVPLFO5430	480	503	54	30	2 7/8
		EVPLFO5436	545	571	54	36	2 7/8
		EVPLFO5442	614	645	54	42	2 7/8
		EVPLFO5448	663	696	54	48	2 7/8
		EVPLFO5454	733	771	54	54	2 7/8
		EVPLFO5460	804	847	54	60	2 7/8
	Open Middle Light Panel - 12”H Opening - 66” High	EVPLFO6618	394	414	60	18	2 7/8
		EVPLFO6624	456	481	60	24	2 7/8
		EVPLFO6630	524	554	60	30	2 7/8
		EVPLFO6636	597	631	60	36	2 7/8
		EVPLFO6642	672	711	60	42	2 7/8
		EVPLFO6648	726	771	60	48	2 7/8
		EVPLFO6654	805	855	60	54	2 7/8
		EVPLFO6660	880	935	60	60	2 7/8

**EVFPFO - OPEN MIDDLE PREMIUM PANEL - 12”H OPENING**

- Open Middle Premium Panel incorporates a 12”H middle position open module with fabric modules, within a steel frame.
- Open Middle Premium Panel Incorporates a 12”H opening above 30”H base module to provide pass-through convenience.
- Premium panels incorporate 12”H modules above 30”H base section.
- Opposite sides of each panel may have a different fabric within the same grade at no upcharge.
- If different grades of fabric are used on one panel, the entire panel must be priced at highest grade.
- An aluminum low profile top cap is included.
- Stackability: Evolve panels can be increased in height in 6”H, 12”H, 18”H or 24”H increments. See Extension Module (pages 82-90) for part numbers.

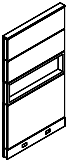
	DESCRIPTION	PRODUCT CODE	LIST PRICE		DIMENSIONS/INCHES		
			Gr1	Gr2	H	W	D
	Open Middle Premium Panel - 12”H Opening - 66” High	EVFPFO6618	472	492	66	18	2 7/8
		EVFPFO6624	547	574	66	24	2 7/8
		EVFPFO6630	629	661	66	30	2 7/8
		EVFPFO6636	712	748	66	36	2 7/8
		EVFPFO6642	810	852	66	42	2 7/8
		EVFPFO6648	871	920	66	48	2 7/8
		EVFPFO6654	967	1019	66	54	2 7/8
		EVFPFO6660	1064	1124	66	60	2 7/8

**EVPLFPO - OPEN MIDDLE PREMIUM LIGHT PANEL - 12” OPENING**

- Open Middle Premium Light Panel incorporates a 12”H middle position open module with fabric modules, within a steel frame.
- Open Middle Premium Light Panel Incorporates a 12”H opening above 30”H base module to provide pass-through convenience.
- Premium panels incorporate 12”H modules above 30”H base section.
- There is no base raceway in Light Panels to accommodate electrical.
- Light Panel Connectors must be used in conjunction with Light Panels.
- Opposite sides of each panel may have a different fabric within the same grade at no upcharge.
- If different grades of fabric are used on one panel, the entire panel must be priced at highest grade.
- An aluminum low profile top cap is included.
- Stackability: Evolve panels can be increased in height in 6”H, 12”H, 18”H or 24”H increments. See Extension Module (pages 82-90) for part numbers.

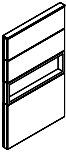
	DESCRIPTION	PRODUCT CODE	LIST PRICE		DIMENSIONS/INCHES		
			Gr1	Gr2	H	W	D
	Open Middle Premium Light Panel - 12”H Opening - 66” High	EVPLFPO6618	448	468	66	18	2 7/8
		EVPLFPO6624	520	545	66	24	2 7/8
		EVPLFPO6630	598	627	66	30	2 7/8
		EVPLFPO6636	676	710	66	36	2 7/8
		EVPLFPO6642	770	810	66	42	2 7/8
		EVPLFPO6648	828	873	66	48	2 7/8
		EVPLFPO6654	918	968	66	54	2 7/8
		EVPLFPO6660	1011	1067	66	60	2 7/8



**EVFFOX - OPEN MIDDLE PANEL - 24”H OPENING**

- Open Middle Panel incorporates a 24”H middle position open module with fabric modules, within a steel frame.
- Open Middle Panel Incorporates a 24”H opening above 30”H base module to provide pass-through convenience.
- Opposite sides of each panel may have a different fabric within the same grade at no upcharge.
- If different grades of fabric are used on one panel, the entire panel must be priced at highest grade.
- An aluminum low profile top cap is included.
- Stackability: Evolve panels can be increased in height in 6”H, 12”H, 18”H or 24”H increments. See Extension Module (pages 82-90) for part numbers.

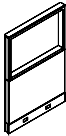
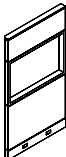
	DESCRIPTION	PRODUCT CODE	LIST PRICE		DIMENSIONS/INCHES		
			Gr1	Gr2	H	W	D
	Open Middle Panel - 24”H Opening - 54” High	EVFFOX5418	314	324	54	18	2 7/8
		EVFFOX5424	358	372	54	24	2 7/8
		EVFFOX5430	411	425	54	30	2 7/8
		EVFFOX5436	460	480	54	36	2 7/8
		EVFFOX5442	511	533	54	42	2 7/8
		EVFFOX5448	553	577	54	48	2 7/8
		EVFFOX5454	607	632	54	54	2 7/8
		EVFFOX5460	658	689	54	60	2 7/8
	Open Middle Panel - 24”H Opening - 66” High	EVFFOX6618	409	424	66	18	2 7/8
		EVFFOX6624	470	490	66	24	2 7/8
		EVFFOX6630	553	577	66	30	2 7/8
		EVFFOX6636	603	629	66	36	2 7/8
		EVFFOX6642	677	710	66	42	2 7/8
		EVFFOX6648	726	761	66	48	2 7/8
		EVFFOX6654	801	840	66	54	2 7/8
		EVFFOX6660	874	920	66	60	2 7/8

**EVPLFOX - OPEN MIDDLE LIGHT PANEL - 24”H OPENING**

- Open Middle Panel incorporates a 24”H middle position open module with fabric modules, within a steel frame.
- Open Middle Panel Incorporates a 24”H opening above 30”H base module to provide pass-through convenience.
- There is no base raceway in Light Panels to accommodate electrical.
- Light Panel Connectors must be used in conjunction with Light Panels.
- Opposite sides of each panel may have a different fabric within the same grade at no upcharge.
- If different grades of fabric are used on one panel, the entire panel must be priced at highest grade.
- An aluminum low profile top cap is included.
- Stackability: Evolve panels can be increased in height in 6”H, 12”H, 18”H or 24”H increments. See Extension Module (pages 82-90) for part numbers.

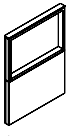
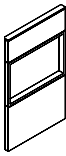
	DESCRIPTION	PRODUCT CODE	LIST PRICE		DIMENSIONS/INCHES		
			Gr1	Gr2	H	W	D
	Open Middle Light Panel - 24”H Opening - 54” High	EVPLFOX5418	299	308	54	18	2 7/8
		EVPLFOX5424	340	353	54	24	2 7/8
		EVPLFOX5430	390	404	54	30	2 7/8
		EVPLFOX5436	438	456	54	36	2 7/8
		EVPLFOX5442	484	505	54	42	2 7/8
		EVPLFOX5448	524	547	54	48	2 7/8
		EVPLFOX5454	577	602	54	54	2 7/8
		EVPLFOX5460	626	654	54	60	2 7/8
	Open Middle Light Panel - 24”H Opening - 66” High	EVPLFOX6618	388	403	66	18	2 7/8
		EVPLFOX6624	446	466	66	24	2 7/8
		EVPLFOX6630	524	547	66	30	2 7/8
		EVPLFOX6636	572	598	66	36	2 7/8
		EVPLFOX6642	644	674	66	42	2 7/8
		EVPLFOX6648	689	723	66	48	2 7/8
		EVPLFOX6654	761	798	66	54	2 7/8
		EVPLFOX6660	831	873	66	60	2 7/8

**EVLEP - 1" LAMINATE END PANEL**

- 1" Laminate End Panel attaches to an end of run connector.
- Left Hand or Right Hand available.
- Finished in thermally Fused Laminate.
- Includes threaded metal inserts and support brackets to attach a worksurface on one side.
- 1" Laminate end panel have panel leveling glides.
- If wood grain is selected, grain runs vertically.

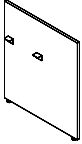
	DESCRIPTION	PRODUCT CODE	LIST PRICE LP	DIMENSIONS/INCHES		
				H	W	D
	1" Laminate End Panel - Right - 42" High	EVLEPR4224	252	42	24	1
		EVLEPR4230	315	42	30	1
		EVLEPR4236	378	42	36	1
		EVLEPR4242	441	42	42	1
		EVLEPR4248	505	42	48	1
	1" Laminate End Panel - Left - 42" High	EVLEPL4224	252	42	24	1
		EVLEPL4230	315	42	30	1
		EVLEPL4236	378	42	36	1
		EVLEPL4242	441	42	42	1
		EVLEPL4248	505	42	48	1
	1" Laminate End Panel - Right - 48" High	EVLEPR4824	285	48	24	1
		EVLEPR4830	361	48	30	1
		EVLEPR4836	432	48	36	1
		EVLEPR4842	503	48	42	1
		EVLEPR4848	576	48	48	1
	1" Laminate End Panel - Left - 48" High	EVLEPL4824	285	48	24	1
		EVLEPL4830	361	48	30	1
		EVLEPL4836	432	48	36	1
		EVLEPL4842	503	48	42	1
		EVLEPL4848	576	48	48	1

**EVLMP - 1" LAMINATE MIDDLE PANEL**

- 1" Laminate Middle Panel attaches to a double inline connector.
- Finished in thermally Fused Laminate.
- Includes threaded metal inserts and support brackets to attach worksurfaces on both sides.
- 1" Laminate middle panel has panel leveling glides.
- If wood grain is selected, grain runs vertically.

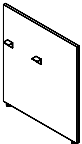
	DESCRIPTION	PRODUCT CODE	LIST PRICE LP	DIMENSIONS/INCHES		
				H	W	D
	1" Laminate Middle Panel - 42" High	EVLMP4224	281	42	24	1
		EVLMP4230	343	42	30	1
		EVLMP4236	407	42	36	1
		EVLMP4242	472	42	42	1
		EVLMP4248	569	42	48	1
	1" Laminate Middle Panel - 48" High	EVLMP4824	314	48	24	1
		EVLMP4830	389	48	30	1
		EVLMP4836	460	48	36	1
		EVLMP4842	533	48	42	1
		EVLMP4848	606	48	48	1



**EVLEPXXYYA - 1" LAMINATE END PANEL WITH ACCESSORY RAIL**

- 1" Laminate End Panel attaches to an end of run connector.
- Includes accessory rail.
- Accessories can be used on accessory rail. Please see accessory section for additional details.
- Finished in thermally Fused Laminate.
- Includes threaded metal inserts and support brackets to attach a worksurface on one side.
- 1" Laminate end panel have panel leveling glides.
- If wood grain is selected, grain runs vertically.

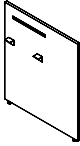
	DESCRIPTION	PRODUCT CODE	LIST PRICE LP	DIMENSIONS/INCHES		
				H	W	D
	1" Laminate End Panel with Accessory Rail - Right - 42" High	EVLEPR4224A	286	42	24	1
		EVLEPR4230A	348	42	30	1
		EVLEPR4236A	412	42	36	1
		EVLEPR4242A	477	42	42	1
		EVLEPR4248A	543	42	48	1
	1" Laminate End Panel with Accessory Rail - Left - 42" High	EVLEPL4224A	286	42	24	1
		EVLEPL4230A	348	42	30	1
		EVLEPL4236A	412	42	36	1
		EVLEPL4242A	477	42	42	1
		EVLEPL4248A	543	42	48	1
	1" Laminate End Panel with Accessory Rail - Right - 48" High	EVLEPR4824A	319	48	24	1
		EVLEPR4830A	387	48	30	1
		EVLEPR4836A	437	48	36	1
		EVLEPR4842A	500	48	42	1
		EVLEPR4848A	612	48	48	1
	1" Laminate End Panel with Accessory Rail - Left - 48" High	EVLEPL4824A	319	48	24	1
		EVLEPL4830A	387	48	30	1
		EVLEPL4836A	437	48	36	1
		EVLEPL4842A	500	48	42	1
		EVLEPL4848A	612	48	48	1

**EVLMPXXYYA - 1" LAMINATE MIDDLE PANEL WITH ACCESSORY RAIL**

- 1" Laminate Middle Panel attaches to a double inline connector.
- Includes accessory rail.
- Accessories can be used on accessory rail. Please see accessory section for additional details.
- Finished in thermally Fused Laminate.
- Includes threaded metal inserts and support brackets to attach a worksurface on one side.
- 1" Laminate middle panel has panel leveling glides.
- If wood grain is selected, grain runs vertically.

	DESCRIPTION	PRODUCT CODE	LIST PRICE LP	DIMENSIONS/INCHES		
				H	W	D
	1" Laminate Middle Panel with Accessory Rail - 42" High	EVLMP4224A	321	42	24	1
		EVLMP4230A	385	42	30	1
		EVLMP4236A	452	42	36	1
		EVLMP4242A	514	42	42	1
		EVLMP4248A	581	42	48	1
	1" Laminate Middle Panel with Accessory Rail - 48" High	EVLMP4824A	354	48	24	1
		EVLMP4830A	432	48	30	1
		EVLMP4836A	503	48	36	1
		EVLMP4842A	576	48	42	1
		EVLMP4848A	649	48	48	1

**EVPDIC - DOUBLE INLINE PANEL CONNECTOR**

- Used to connect 1" laminate middle panel to panels of equal height in a straight run.
- Aluminum top trim for double inline connector must be used.
- Provides slotted support for worksurfaces and hardware support.
- Includes two slotted posts with leveling glides and connection hardware.
- Use 17" flexible mesh jumper cable to pass-through panels.

DESCRIPTION	PRODUCT CODE	LIST PRICE	DIMENSIONS/INCHES		
			H	W	D
Double Inline Panel Connector	EVPDIC42	111	42	2	
	EVPDIC48	117	48	2	

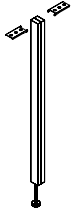

**EVPBIC - BELTLINE DOUBLE INLINE PANEL CONNECTOR**

- Used to connect 1" laminate middle panel to panels of equal height in a straight run.
- Use in-between beltline panels.
- Aluminum top trim for double inline connector must be used.
- Provides slotted support for worksurfaces and hardware support.
- Includes two slotted posts with leveling glides and connection hardware.
- Use 17" flexible mesh jumper cable to pass-through panels.

DESCRIPTION	PRODUCT CODE	LIST PRICE	DIMENSIONS/INCHES		
			H	W	D
Beltline Double Inline Panel Connector	EVPBIC42	111	42	2	
	EVPBIC48	117	48	2	

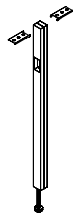

**EVPDVTF - DOUBLE INLINE CONNECTOR TRIM**

- Attaches to exposed side of double inline connector.

	DESCRIPTION	PRODUCT CODE	LIST PRICE	DIMENSIONS/INCHES		
				H	W	D
	Double Inline Connector Trim	EVPDVTF42	12	42		
		EVPDVTF48	16	48		

**EVPTTA - DOUBLE INLINE PANEL CONNECTOR TOP TRIM - ALUMINUM**

- Aluminum top trim is longer by 1.125" to cover width of panel and double inline connector.
- Trim cannot span a post connector.
- Available in standard and premium paint colors.

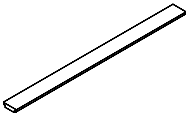
	DESCRIPTION	PRODUCT CODE	LIST PRICE	DIMENSIONS/INCHES		
				H	W	D
	Double Inline Connector Trim - Aluminum	EVPTTA25	14		25	
		EVPTTA31	16		31	
		EVPTTA37	12		37	
		EVPTTA43	22		43	
		EVPTTA49	30		49	
		EVPTTA55	34		55	
		EVPTTA61	38		61	
		EVPTTA67	42		67	
		EVPTTA73	47		73	
		EVPTTA79	52		79	
EVPTTA85	56		83			



**EVPDS - DOOR PANEL - SOLID**

- All door surfaces are high pressure laminate
- HP Laminate finish available in all standard Evolve colors (see Textiles & Finishes page 240-241)
- Two panel widths: 36" or 42" High
- 84" Door Panel height = 66"H panel plus one 18"H Panel Extension Module
- 90" Door Panel height = 66" H panel plus one 24"H or two 12"H Panel Extension Modules
- Door and door trim can be specified left- or right-handed (see diagram below)
- Handedness of Door Panel can be changed in the field
- Select door frame color from standard trim colors (see Textiles & Finishes pages 240-241).
- Door Sizes:
  - 36"W Door is 33.63"W without frame (This door is not ADA compliant)
  - 42"W Door is 39.63"W without frame
  - 84"H Door is 81.5"H without frame
  - 90"H Door is 87.5"H without frame
- If laminate is selected in a wood grain, the grain runs vertical.
- Customer is responsible to confirm and meet all city, county or any other municipality codes in relation to door clearances.

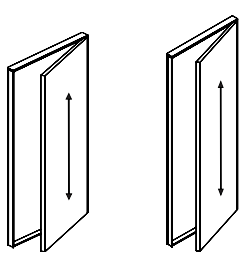
	DESCRIPTION	PRODUCT CODE	LIST PRICE HPL	DIMENSIONS/INCHES		
				H	W	D
 <p>84" Door</p> <p>90" Door</p>	Door Panel - Solid - 84" High x 36" Wide	EVPDS8436L EVPDS8436R	1928 1928	84 84	36 36	2 7/8 2 7/8
	Door Panel - Solid - 84" High x 42" Wide	EVPDS8442L EVPDS8442R	2230 2230	84 84	42 42	2 7/8 2 7/8
	Door Panel - Solid - 90" High x 36" Wide	EVPDS9036L EVPDS9036R	1928 1928	90 90	36 36	2 7/8 2 7/8
	Door Panel - Solid - 90" High x 42" Wide	EVPDS9042L EVPDS9042R	2230 2230	90 90	42 42	2 7/8 2 7/8

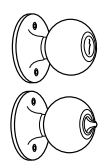
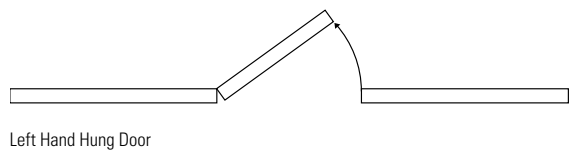
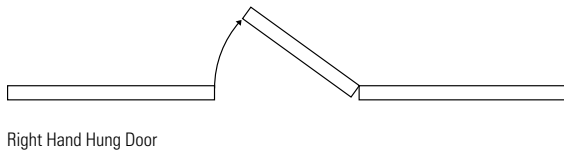

Knob Lock Set  
(Knob Lock Set is not ADA compliant)  
Lock set sold separately from doors.  
Specific core #'s and Master Key not available

EVPDSL01 78

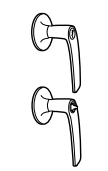

Lever Lock Set  
Lock set sold separately from doors.  
Specific core #'s and Master Key not available

EVPDSL02 109

**EVHFF01 - HIGH PROFILE FOOT**

- Used to provide additional support to a panel run without adding additional panels.
- Connects to the inline connector or end of run at the base of the panel.

	DESCRIPTION	PRODUCT CODE	LIST PRICE	DIMENSIONS/INCHES		
				H	W	D
	High Profile Foot	EVHFF01	232	6	1	21

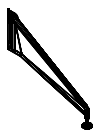

**EVPDSL/R - SLIDING PRIVACY DOOR**

- Sliding Privacy Door attaches to Evolve Panels using standard connectors to add privacy. Brackets that attach to Connectors are included.
- This door must mount on panels of equal width. It is also intended to be used for openings of equal width.
- Left (L) or right-handedness (R) is determined by the direction of door movement (from compressed to expanded position), while facing the door on the panel mounted side.
- Painted frame may match any Evolve Standard Paint Finish. The door interior is standard with a louvered acrylic finish.
- Telescoping arms eliminate the need for thresholds, wheels or casters.
- 81”H door must connect to panels 84” or higher.
- Thickness of louvered acrylic is 6 mm.

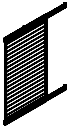
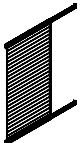
	DESCRIPTION	PRODUCT CODE	LIST PRICE	DIMENSIONS/INCHES		
				H	W	D
	Sliding Privacy Door - 66” High	EVPDSL6636R	1980	66	36	
		EVPDSL6636L	1980	66	36	
		EVPDSL6642R	2031	66	42	
		EVPDSL6642L	2031	66	42	
	Sliding Privacy Door - 81” High	EVPDSL8136R	2090	81	36	
		EVPDSL8136L	2090	81	36	
		EVPDSL8142R	2245	81	42	
		EVPDSL8142L	2245	81	42	

**EVPDSLLOCK - SLIDING DOOR LOCK**

- Lock bracket attaches to sliding door with screws.
- Includes strike plate bracket which attaches to slots in connector.
- Lock included.
- Lock sets sold separately from sliding doors.
- Available in Tungsten only.

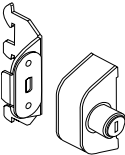
	DESCRIPTION	PRODUCT CODE	LIST PRICE	DIMENSIONS/INCHES		
				H	W	D
	Sliding Door Lock - Right	EVPSLOCKR	180	2.65	1.2	0.9
	Sliding Door Lock - Left	EVPSLOCKL	180	2.65	1.2	0.9

**EVMPK02 - MINI PANEL KIT**

- Evolve’s Mini Panel Kits are now available to our dealers and their sales staff. The Evolve mini panel is an excellent sales tool featuring a cut away of a module and samples of various hardware and electrical components and consists of the following:
- 1 EVFP3024 30 x 24 Premium with cut-away
- 1 EVPCP232 Two-way corner post
- 1 EVPER30 End of run trim kit
- 1 EVDHPT24 High Profile Top Cap
- 1 EVDCPHP2 Two-way High Profile Top Cap
- 1 EVDPE4 Post Extension Lay in
- 1 EVE8PD24 Power distribution housing
- 1 EVE8CP16 Jumper Cable
- 1 EVE8RDA/B Duplex Receptacle
- 1 Pizza cutter spline tool
- 1 Replacement fabric
- 1 Panel Bag with Evolve Logo
- 1 Parts Bag with Evolve Logo

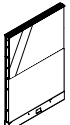
	DESCRIPTION	PRODUCT CODE	LIST PRICE	DIMENSIONS/INCHES		
				H	W	D
	Mini Panel Kit	EVMPK02	1421	30	24	2 7/8



When ordering Panel Extension Modules, Inline Panel Extension Connectors (EVPIEC) must be ordered separately. Please see EVPIEC for details.

Inline Panel Extension Connectors connect two panel extension modules of equal height in a straight run.

Extension connectors do **not** provide support for hang-on storage components above 66" H.

When specifying stacking panels up to 66" H and using a single full height connector additional single clamps (EVCLVAR \$6 list each) are recommended. Order 2 clamps per extension module.

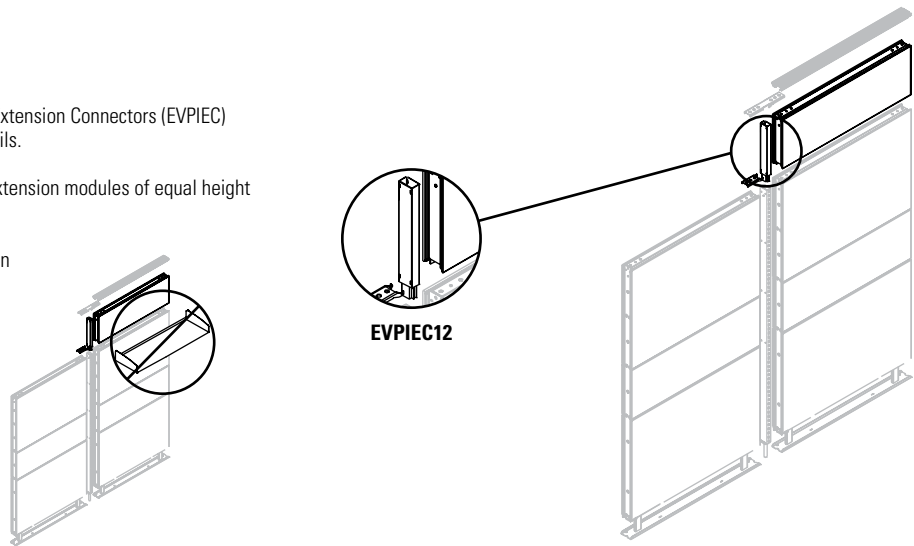

## EXTENSION MODULES BY TYPE

### Fabric Panel Extension Module

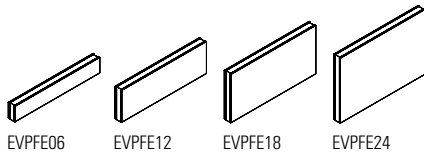

### Fabric Panel Extension Module - Premium

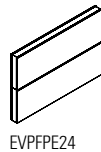

### Tempered Glass Panel Extension Module

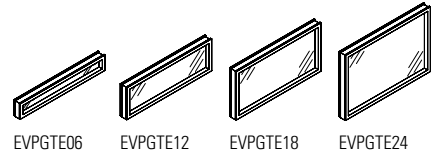

### Tempered Glass Panel Extension Module - Premium

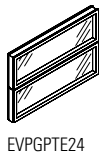

### Write Board Extension Module - Single Sided

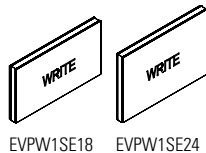

### Write Board Extension Module - Double Sided

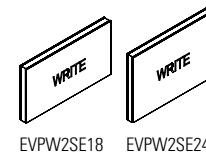

### Laminate Extension Module - Single Sided

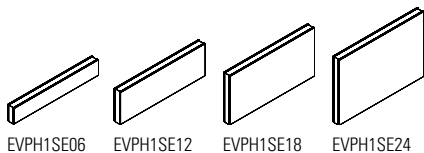

### Laminate Extension Module - Double Sided

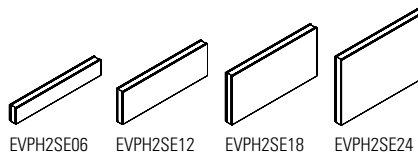

### Air Flow Extension Module

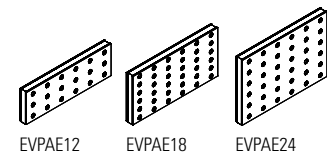

### Open Panel Extension Module

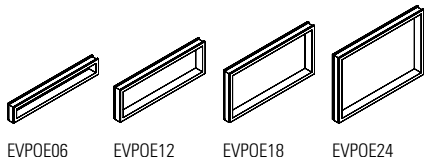

### Panel Mount Privacy Glass

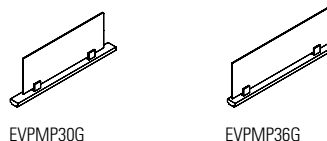

**EVPFE - FABRIC PANEL EXTENSION MODULE**

- Attaches on top of a panel.
- Modules can be stacked to add privacy or divide space.
- Panel Extension Modules are not load bearing if installed higher than 66" High.
- Each side of the fabric module may have a different fabric within the same grade at no charge.
- If different grades of fabric are used on one module, the entire module must be priced at highest grade.
- When ordering Panel Extension Modules, additional connectors are required.

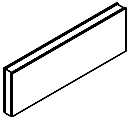
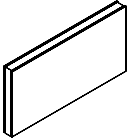
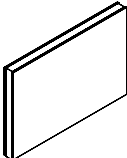
	DESCRIPTION	PRODUCT CODE	LIST PRICE		DIMENSIONS/INCHES		
			Gr1	Gr2	H	W	D
	Fabric Panel Extension Module - 6" High	EVPFE0618	123	127	6	18	2 7/8
		EVPFE0624	125	131	6	24	2 7/8
		EVPFE0630	136	146	6	30	2 7/8
		EVPFE0636	152	163	6	36	2 7/8
		EVPFE0642	171	180	6	42	2 7/8
		EVPFE0648	185	197	6	48	2 7/8
		EVPFE0654	199	212	6	54	2 7/8
	Fabric Panel Extension Module - 12" High	EVPFE1218	123	127	12	18	2 7/8
		EVPFE1224	125	131	12	24	2 7/8
		EVPFE1230	136	146	12	30	2 7/8
		EVPFE1236	152	163	12	36	2 7/8
		EVPFE1242	171	180	12	42	2 7/8
		EVPFE1248	185	197	12	48	2 7/8
		EVPFE1254	199	212	12	54	2 7/8
	Fabric Panel Extension Module - 18" High	EVPFE1818	149	158	18	18	2 7/8
		EVPFE1824	155	168	18	24	2 7/8
		EVPFE1830	168	184	18	30	2 7/8
		EVPFE1836	194	211	18	36	2 7/8
		EVPFE1842	213	235	18	42	2 7/8
		EVPFE1848	233	256	18	48	2 7/8
		EVPFE1854	253	279	18	54	2 7/8
	Fabric Panel Extension Module - 24" High	EVPFE2418	149	158	24	18	2 7/8
		EVPFE2424	155	168	24	24	2 7/8
		EVPFE2430	168	184	24	30	2 7/8
		EVPFE2436	194	211	24	36	2 7/8
		EVPFE2442	213	235	24	42	2 7/8
		EVPFE2448	233	256	24	48	2 7/8
		EVPFE2454	253	279	24	54	2 7/8
EVPFE2460	275	303	24	60	2 7/8		

**EVPFPE - FABRIC PANEL EXTENSION MODULE - PREMIUM**

- Attaches on top of a panel.
- Modules can be stacked to add privacy or to divide space.
- Panel Extension Modules are not load bearing above 66" High.
- Each side of each module may have a different fabric within the same grade at no charge.
- If different grades of fabric are used on the Panel Extension Module, the module must be priced at highest grade.
- When ordering Panel Extension Modules, additional connectors are required.

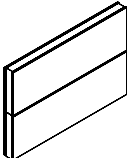
	DESCRIPTION	PRODUCT CODE	LIST PRICE		DIMENSIONS/INCHES		
			Gr1	Gr2	H	W	D
	Fabric Panel Extension Module - Premium - 24" High	EVPFPE2418	201	211	24	18	2 7/8
		EVPFPE2424	214	228	24	24	2 7/8
		EVPFPE2430	241	256	24	30	2 7/8
		EVPFPE2436	272	289	24	36	2 7/8
		EVPFPE2442	305	327	24	42	2 7/8
		EVPFPE2448	327	350	24	48	2 7/8
		EVPFPE2454	362	388	24	54	2 7/8
		EVPFPE2460	394	423	24	60	2 7/8

**EVPGTE - TEMPERED GLASS PANEL EXTENSION MODULE**

- Attaches on top of panel.
- Modules can be stacked to add privacy or to divide space.
- Panel Extension Modules are not load bearing above 66" H.
- Standard in clear (CLR) or smoked glass (SMK) as an option.
- Frosted Glass (FRST) 40% upcharge. Contact EVOLVE Customer Support for details.
- When ordering Panel Extension Modules, additional connectors are required.

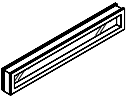
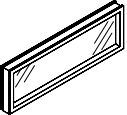
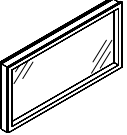
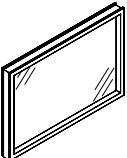
	DESCRIPTION	PRODUCT CODE	LIST PRICE	DIMENSIONS/INCHES		
				H	W	D
	Tempered Glass Panel Extension Module - 6" High	EVPGTE0618	237	6	18	2 7/8
		EVPGTE0624	256	6	24	2 7/8
		EVPGTE0630	308	6	30	2 7/8
		EVPGTE0636	323	6	36	2 7/8
		EVPGTE0642	394	6	42	2 7/8
		EVPGTE0648	441	6	48	2 7/8
		EVPGTE0654	482	6	54	2 7/8
		EVPGTE0660	519	6	60	2 7/8
	Tempered Glass Panel Extension Module - 12" High	EVPGTE1218	237	12	18	2 7/8
		EVPGTE1224	256	12	24	2 7/8
		EVPGTE1230	308	12	30	2 7/8
		EVPGTE1236	323	12	36	2 7/8
		EVPGTE1242	394	12	42	2 7/8
		EVPGTE1248	441	12	48	2 7/8
		EVPGTE1254	482	12	54	2 7/8
		EVPGTE1260	519	12	60	2 7/8
	Tempered Glass Panel Extension Module - 18" High	EVPGTE1818	357	18	18	2 7/8
		EVPGTE1824	369	18	24	2 7/8
		EVPGTE1830	393	18	30	2 7/8
		EVPGTE1836	430	18	36	2 7/8
		EVPGTE1842	488	18	42	2 7/8
		EVPGTE1848	547	18	48	2 7/8
		EVPGTE1854	593	18	54	2 7/8
		EVPGTE1860	636	18	60	2 7/8
	Tempered Glass Panel Extension Module - 24" High	EVPGTE2418	357	24	18	2 7/8
		EVPGTE2424	369	24	24	2 7/8
		EVPGTE2430	393	24	30	2 7/8
		EVPGTE2436	430	24	36	2 7/8
		EVPGTE2442	488	24	42	2 7/8
		EVPGTE2448	547	24	48	2 7/8
		EVPGTE2454	593	24	54	2 7/8
		EVPGTE2460	636	24	60	2 7/8

**EVPGPTE - TEMPERED GLASS PREMIUM PANEL EXTENSION MODULE**

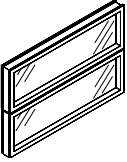

- Attaches to top of a panel.
- Modules can be stacked to add privacy or to divide space.
- Panel Extension Modules are not load bearing above 66" H.
- Standard in clear (CLR) or smoked glass (SMK) as an option.
- Frosted Glass (FRST) 40% upcharge. Contact EVOLVE Customer Support for details.
- When ordering Panel Extension Modules, additional connectors are required.

	DESCRIPTION	PRODUCT CODE	LIST PRICE	DIMENSIONS/INCHES		
				H	W	D
	Tempered Glass Premium Panel Extension Module - 24" High	EVPGPTE2418	352	24	18	2 7/8
		EVPGPTE2424	391	24	24	2 7/8
		EVPGPTE2430	446	24	30	2 7/8
		EVPGPTE2436	509	24	36	2 7/8
		EVPGPTE2442	564	24	42	2 7/8
		EVPGPTE2448	633	24	48	2 7/8
		EVPGPTE2454	690	24	54	2 7/8
		EVPGPTE2460	748	224	60	2 7/8





**EVPW1SE - WRITE BOARD EXTENSION MODULE - SINGLE SIDED**

- Attaches on top of a panel.
- Provides writing surface on a Single Side.
- Modules can be stacked to add privacy or to divide space.
- Panel Extension Modules are not load bearing above 66" H.
- When ordering Panel Extension Modules, additional connectors are required.
- High pressure only
- Use erasable Write Board markers only.

	DESCRIPTION	PRODUCT CODE	LIST PRICE		DIMENSIONS/INCHES		
			Gr1	Gr2	H	W	D
	Write Board Extension Module - Single Sided 18"High	EVPW1SE1818	180	186	18	18	2 7/8
		EVPW1SE1824	207	213	18	24	2 7/8
		EVPW1SE1830	231	238	18	30	2 7/8
		EVPW1SE1836	271	280	18	36	2 7/8
		EVPW1SE1842	303	314	18	42	2 7/8
		EVPW1SE1848	333	346	18	48	2 7/8
		EVPW1SE1854	363	375	18	54	2 7/8
		EVPW1SE1860	391	405	18	60	2 7/8
	Write Board Extension Module - Single Sided 24"High	EVPW1SE2418	180	186	24	18	2 7/8
		EVPW1SE2424	207	213	24	24	2 7/8
		EVPW1SE2430	231	238	24	30	2 7/8
		EVPW1SE2436	271	280	24	36	2 7/8
		EVPW1SE2442	303	314	24	42	2 7/8
		EVPW1SE2448	333	346	24	48	2 7/8
		EVPW1SE2454	363	375	24	54	2 7/8
		EVPW1SE2460	391	405	24	60	2 7/8

**EVPW2SE - WRITE BOARD EXTENSION MODULE - DOUBLE SIDED**

- Attaches on top of a panel.
- Provides writing surface on two sides.
- Modules can be stacked to add privacy or to divide space.
- Panel Extension Modules are not load bearing above 66" H.
- When ordering Panel Extension Modules, additional connectors are required.
- High pressure only
- Use erasable Write Board markers only.

	DESCRIPTION	PRODUCT CODE	LIST PRICE	DIMENSIONS/INCHES		
				H	W	D
	Write Board Extension Module - Double Sided - 18"High	EVPW2SE1818	218	18	18	2 7/8
		EVPW2SE1824	256	18	24	2 7/8
		EVPW2SE1830	295	18	30	2 7/8
		EVPW2SE1836	347	18	36	2 7/8
		EVPW2SE1842	391	18	42	2 7/8
		EVPW2SE1848	437	18	48	2 7/8
		EVPW2SE1854	483	18	54	2 7/8
		EVPW2SE1860	527	18	60	2 7/8
	Write Board Extension Module - Double Sided - 24"High	EVPW2SE2418	218	24	18	2 7/8
		EVPW2SE2424	256	24	24	2 7/8
		EVPW2SE2430	295	24	30	2 7/8
		EVPW2SE2436	347	24	36	2 7/8
		EVPW2SE2442	391	24	42	2 7/8
		EVPW2SE2448	437	24	48	2 7/8
		EVPW2SE2454	483	24	54	2 7/8
		EVPW2SE2460	527	24	60	2 7/8

**EVPH1SE - LAMINATE EXTENSION MODULE - SINGLE SIDED**

- Attaches on top of a panel.
- Laminate face on the module provides a durable, washable surface on Single Side of the panel.
- Modules can be stacked to add privacy or to divide space.
- Panel Extension Modules are not load bearing above 66" H.
- When ordering Panel Extension Modules, additional connectors are required.
- Available in high pressure only.

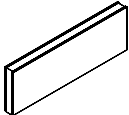
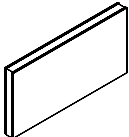
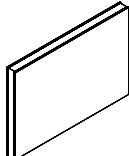
	DESCRIPTION	PRODUCT CODE	LIST PRICE		DIMENSIONS/INCHES		
			Gr1	Gr2	H	W	D
	Laminate Extension Module - Single Sided 6" High	EVPH1SE0618	168	172	6	18	2 7/8
		EVPH1SE0624	195	197	6	24	2 7/8
		EVPH1SE0630	219	221	6	30	2 7/8
		EVPH1SE0636	249	252	6	36	2 7/8
		EVPH1SE0642	281	283	6	42	2 7/8
		EVPH1SE0648	307	315	6	48	2 7/8
		EVPH1SE0654	347	353	6	54	2 7/8
EVPH1SE0660	364	368	6	60	2 7/8		
	Laminate Extension Module - Single Sided 12" High	EVPH1SE1218	168	171	12	18	2 7/8
		EVPH1SE1224	195	201	12	24	2 7/8
		EVPH1SE1230	219	222	12	30	2 7/8
		EVPH1SE1236	249	254	12	36	2 7/8
		EVPH1SE1242	281	286	12	42	2 7/8
		EVPH1SE1248	307	314	12	48	2 7/8
		EVPH1SE1254	347	353	12	54	2 7/8
EVPH1SE1260	364	371	12	60	2 7/8		
	Laminate Extension Module - Single Sided 18" High	EVPH1SE1818	224	230	18	18	2 7/8
		EVPH1SE1824	265	272	18	24	2 7/8
		EVPH1SE1830	305	314	18	30	2 7/8
		EVPH1SE1836	349	358	18	36	2 7/8
		EVPH1SE1842	393	404	18	42	2 7/8
		EVPH1SE1848	432	444	18	48	2 7/8
		EVPH1SE1854	469	482	18	54	2 7/8
EVPH1SE1860	515	530	18	60	2 7/8		
	Laminate Extension Module - Single Sided 24" High	EVPH1SE2418	224	230	24	18	2 7/8
		EVPH1SE2424	265	272	24	24	2 7/8
		EVPH1SE2430	305	314	24	30	2 7/8
		EVPH1SE2436	349	358	24	36	2 7/8
		EVPH1SE2442	393	404	24	42	2 7/8
		EVPH1SE2448	432	444	24	48	2 7/8
		EVPH1SE2454	469	482	24	54	2 7/8
EVPH1SE2460	515	530	24	60	2 7/8		



**EVPH2SE - LAMINATE EXTENSION MODULE - DOUBLE SIDED**

- Attaches on top of a panel.
- Laminate faces on both sides of the module provide durable, washable surfaces
- Modules can be stacked to add privacy or to divide space.
- Panel Extension Modules are not load bearing above 66" H
- When ordering Panel Extension Modules, additional connectors are required.
- Available in high pressure only.

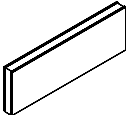
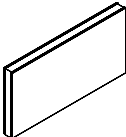
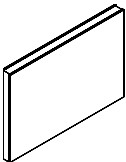
	DESCRIPTION	PRODUCT CODE	LIST PRICE	DIMENSIONS/INCHES		
				H	W	D
	Laminate Extension Module - Double Sided 6" High	EVPH2SE0618	181	6	18	2 7/8
		EVPH2SE0624	213	6	24	2 7/8
		EVPH2SE0630	247	6	30	2 7/8
		EVPH2SE0636	283	6	36	2 7/8
		EVPH2SE0642	321	6	42	2 7/8
		EVPH2SE0648	358	6	48	2 7/8
		EVPH2SE0654	414	6	54	2 7/8
		EVPH2SE0660	424	6	60	2 7/8
	Laminate Extension Module - Double Sided 12" High	EVPH2SE1218	181	12	18	2 7/8
		EVPH2SE1224	213	12	24	2 7/8
		EVPH2SE1230	247	12	30	2 7/8
		EVPH2SE1236	283	12	36	2 7/8
		EVPH2SE1242	321	12	42	2 7/8
		EVPH2SE1248	358	12	48	2 7/8
		EVPH2SE1254	414	12	54	2 7/8
		EVPH2SE1260	424	12	60	2 7/8
	Laminate Extension Module - Double Sided 18" High	EVPH2SE1818	259	18	18	2 7/8
		EVPH2SE1824	314	18	24	2 7/8
		EVPH2SE1830	364	18	30	2 7/8
		EVPH2SE1836	422	18	36	2 7/8
		EVPH2SE1842	477	18	42	2 7/8
		EVPH2SE1848	540	18	48	2 7/8
		EVPH2SE1854	593	18	54	2 7/8
		EVPH2SE1860	639	18	60	2 7/8
	Laminate Extension Module - Double Sided 24" High	EVPH2SE2418	259	24	18	2 7/8
		EVPH2SE2424	314	24	24	2 7/8
		EVPH2SE2430	364	24	30	2 7/8
		EVPH2SE2436	422	24	36	2 7/8
		EVPH2SE2442	477	24	42	2 7/8
		EVPH2SE2448	540	24	48	2 7/8
		EVPH2SE2454	593	24	54	2 7/8
		EVPH2SE2460	639	24	60	2 7/8



**EVPAE - AIR FLOW EXTENSION MODULE**

- Metal air flow panel extension
- Attaches to top of panel
- Modules can be stacked to add privacy or to divide space.
- Panel Extension Modules are not load bearing above 66" H.
- When ordering Panel Extension Modules, additional connectors are required.

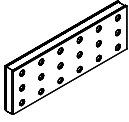
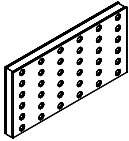
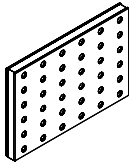
	DESCRIPTION	PRODUCT CODE	LIST PRICE	DIMENSIONS/INCHES		
				H	W	D
	Air Flow Extension Module - 12" High	EVPAE1224	218	12	24	2 7/8
		EVPAE1230	259	12	24	2 7/8
		EVPAE1236	294	12	24	2 7/8
		EVPAE1242	325	12	24	2 7/8
		EVPAE1248	369	12	24	2 7/8
		EVPAE1254	425	18	54	2 7/8
		EVPAE1260	485	12	24	2 7/8
	Air Flow Extension Module - 18" High	EVPAE1824	274	18	24	2 7/8
		EVPAE1830	320	18	30	2 7/8
		EVPAE1836	354	18	36	2 7/8
		EVPAE1842	389	18	42	2 7/8
		EVPAE1848	446	18	48	2 7/8
		EVPAE1854	512	18	54	2 7/8
		EVPAE1860	577	18	60	2 7/8
	Air Flow Extension Module - 24" High	EVPAE2424	274	24	24	2 7/8
		EVPAE2430	320	24	24	2 7/8
		EVPAE2436	354	24	24	2 7/8
		EVPAE2442	389	24	24	2 7/8
		EVPAE2448	446	24	24	2 7/8
		EVPAE2454	509	18	54	2 7/8
		EVPAE2460	577	24	24	2 7/8



**EVPOE - OPEN PANEL EXTENSION MODULE**

- Attaches to top portion of a panel.
- Modules can be stacked to add privacy or to divide space
- Panel Extension Modules are not load bearing above 66" H.
- When ordering Panel Extension Modules, additional connectors are required.

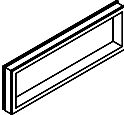
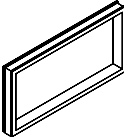
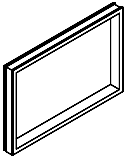
	DESCRIPTION	PRODUCT CODE	LIST PRICE	DIMENSIONS/INCHES		
				H	W	D
	Open Panel Extension Module - 6" High	EVPOE0618	192	6	18	2 7/8
		EVPOE0624	197	6	24	2 7/8
		EVPOE0630	241	6	30	2 7/8
		EVPOE0636	252	6	36	2 7/8
		EVPOE0642	306	6	42	2 7/8
		EVPOE0648	344	6	48	2 7/8
		EVPOE0654	375	6	54	2 7/8
		EVPOE0660	405	6	60	2 7/8
	Open Panel Extension Module - 12" High	EVPOE1218	194	12	18	2 7/8
		EVPOE1224	198	12	24	2 7/8
		EVPOE1230	241	12	30	2 7/8
		EVPOE1236	252	12	36	2 7/8
		EVPOE1242	306	12	42	2 7/8
		EVPOE1248	345	12	48	2 7/8
		EVPOE1254	375	12	54	2 7/8
		EVPOE1260	406	12	60	2 7/8
	Open Panel Extension Module - 18" High	EVPOE1818	285	18	18	2 7/8
		EVPOE1824	288	18	24	2 7/8
		EVPOE1830	306	18	30	2 7/8
		EVPOE1836	334	18	36	2 7/8
		EVPOE1842	377	18	42	2 7/8
		EVPOE1848	425	18	48	2 7/8
		EVPOE1854	461	18	54	2 7/8
		EVPOE1860	497	18	60	2 7/8
	Open Panel Extension Module - 24" High	EVPOE2418	288	24	18	2 7/8
		EVPOE2424	285	24	24	2 7/8
		EVPOE2430	306	24	30	2 7/8
		EVPOE2436	334	24	36	2 7/8
		EVPOE2442	377	24	42	2 7/8
		EVPOE2448	425	24	48	2 7/8
		EVPOE2454	461	24	54	2 7/8
		EVPOE2460	497	24	60	2 7/8

**EVPMPXXGYYS - PANEL MOUNT PRIVACY GLASS**

- **\*\*Will be discontinued on 12/31/2016**
- Attaches on top of Evolve Panels to add privacy or divide space.
- Includes aluminum top trim with two punched holes, glass tile and two clamps.
- Standard in clear (CLR) or frosted (FRST) glass.
- Clamps available in satin chrome finish only.
- Width of glass can be smaller than width of the panel by 6".
- Note: Width dimensions given are width of glass only.

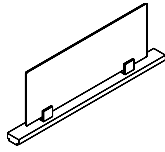
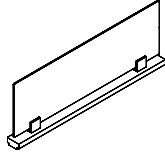
	DESCRIPTION	PRODUCT CODE	LIST PRICE		DIMENSIONS/INCHES		
			Clear	Frosted	H	W	D
 <p>30"W Shown</p>	Panel Mount Privacy Glass - 24" Wide	EVPMP24G18S EVPMP24G24S	200 214	260 263	12 12	17 5/8 23 5/8	6mm 6mm
	Panel Mount Privacy Glass - 30" Wide	EVPMP30G24S EVPMP30G30S	220 234	265 268	12 12	23 5/8 29 5/8	6mm 6mm
	Panel Mount Privacy Glass - 36" Wide	EVPMP36G30S EVPMP36G36S	236 249	271 273	12 12	29 5/8 35 5/8	6mm 6mm
	Panel Mount Privacy Glass - 42" Wide	EVPMP42G36S EVPMP42G42S	252 260	275 301	12 12	35 5/8 41 5/8	6mm 6mm
	Panel Mount Privacy Glass - 48" Wide	EVPMP48G42S EVPMP48G48S	262 275	303 329	12 12	41 5/8 47 5/8	6mm 6mm
	Panel Mount Privacy Glass - 54" Wide	EVPMP54G48S EVPMP54G54S	277 285	331 355	12 12	47 5/8 53 5/8	6mm 6mm
 <p>36"W Shown</p>	Panel Mount Privacy Glass - 60" Wide	EVPMP60G54S EVPMP60G60S	286 295	358 384	12 12	53 5/8 59 5/8	6mm 6mm

**EVPMPNXXGYYS - PANEL MOUNT PRIVACY GLASS W/ NOTCHED TOP TRIM FOR VARIABLE HEIGHT CONNECTOR**

- **\*\*Will be discontinued on 12/31/2016**
- Attaches on top of Evolve Panels to add privacy or divide space.
- Includes notched aluminum trim with two punched holes, glass tile with all square corners and two square clamps.
- Square clamps available in satin chrome only.
- Width of glass is smaller than width of the panel by 2". Width dimensions given are width of glass only.
- Aluminium trim must be specified for entire station when ordering panel mount privacy glass.
- Standard in clear (CLR) or frosted (FRST) glass.

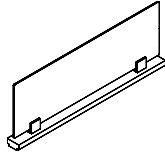
	DESCRIPTION	PRODUCT CODE	LIST PRICE		DIMENSIONS/INCHES		
			Clear	Frosted	H	W	D
 <p>36"W Shown</p>	Panel Mount Privacy Glass w/ Notched Top Trim for Variable Height Connector - 24" Wide	EVPMPN24G22S	214	263	12	21 5/8	6mm
	Panel Mount Privacy Glass w/ Notched Top Trim for Variable Height Connector - 30" Wide	EVPMPN30G28S	234	268	12	27 5/8	6mm
	Panel Mount Privacy Glass w/ Notched Top Trim for Variable Height Connector - 36" Wide	EVPMPN36G34S	249	273	12	33 5/8	6mm
	Panel Mount Privacy Glass w/ Notched Top Trim for Variable Height Connector - 42" Wide	EVPMPN42G40S	260	301	12	39 5/8	6mm
	Panel Mount Privacy Glass w/ Notched Top Trim for Variable Height Connector - 48" Wide	EVPMPN48G46S	275	329	12	45 5/8	6mm
	Panel Mount Privacy Glass w/ Notched Top Trim for Variable Height Connector - 54" Wide	EVPMPN54G52S	285	355	12	51 5/8	6mm
	Panel Mount Privacy Glass w/ Notched Top Trim for Variable Height Connector - 60" Wide	EVPMPN60G58S	295	384	12	57 5/8	6mm



**EVMPMPXXGIP - PANEL MOUNT PRIVACY GLASS W/ ALUMINUM TRIM**

- Attaches on top of Evolve Panels to add privacy or divide space.
- Privacy Glass is integrated into the aluminum top trim.
- Includes aluminum trim with channel and glass tile
- Standard in clear (CLR) or frosted (FRST) glass.

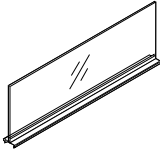
	DESCRIPTION	PRODUCT CODE	LIST PRICE		DIMENSIONS/INCHES		
			Clear	Frosted	H	W	D
 <p>36" W Shown</p>	Panel Mount Privacy Glass w/ Aluminum Trim - 24" Wide	EVMPMP24GIP	193	236	12	24	6mm
	Panel Mount Privacy Glass w/ Aluminum Trim - 30" Wide	EVMPMP30GIP	210	241	12	30	6mm
	Panel Mount Privacy Glass w/ Aluminum Trim - 36" Wide	EVMPMP36GIP	224	246	12	36	6mm
	Panel Mount Privacy Glass w/ Aluminum Trim - 42" Wide	EVMPMP42GIP	234	271	12	42	6mm
	Panel Mount Privacy Glass w/ Aluminum Trim - 48" Wide	EVMPMP48GIP	248	296	12	48	6mm
	Panel Mount Privacy Glass w/ Aluminum Trim - 54" Wide	EVMPMP54GIP	257	320	12	54	6mm
	Panel Mount Privacy Glass w/ Aluminum Trim - 60" Wide	EVMPMP60GIP	265	346	12	60	6mm

**EVMPMPXXGI6P - 6" H PANEL MOUNT PRIVACY GLASS W/ ALUMINUM TRIM**

- Attaches on top of Evolve Panels to add privacy or divide space.
- Privacy Glass is integrated into the aluminum top trim.
- Aluminum trim must be specified for entire station when ordering panel mount privacy glass.
- Includes aluminum trim with channel and glass tile
- Glass and attachment hardware ship separately.
- Standard in clear (CLR) or frosted (FRST) glass.

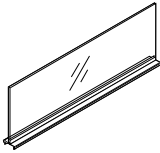
	DESCRIPTION	PRODUCT CODE	LIST PRICE		DIMENSIONS/INCHES		
			Clear	Frosted	H	W	D
 <p>36" W Shown</p>	6" H Panel Mount Privacy Glass w/ Aluminum Trim - 24" Wide	EVMPMP24GI6P	193	236	6	24	6mm
	6" H Panel Mount Privacy Glass w/ Aluminum Trim - 30" Wide	EVMPMP30GI6P	210	241	6	30	6mm
	6" H Panel Mount Privacy Glass w/ Aluminum Trim - 36" Wide	EVMPMP36GI6P	224	246	6	36	6mm
	6" H Panel Mount Privacy Glass w/ Aluminum Trim - 42" Wide	EVMPMP42GI6P	234	271	6	42	6mm
	6" H Panel Mount Privacy Glass w/ Aluminum Trim - 48" Wide	EVMPMP48GI6P	248	296	6	48	6mm
	6" H Panel Mount Privacy Glass w/ Aluminum Trim - 54" Wide	EVMPMP54GI6P	257	320	6	54	6mm
	6" H Panel Mount Privacy Glass w/ Aluminum Trim - 60" Wide	EVMPMP60GI6P	265	346	6	60	6mm

**EVPMPXXGI9P - 9" H PANEL MOUNT PRIVACY GLASS W/ ALUMINUM TRIM**

- Attaches on top of Evolve Panels to add privacy or divide space.
- Privacy Glass is integrated into the aluminum top trim.
- Aluminum trim must be specified for entire station when ordering panel mount privacy glass.
- Includes aluminum trim with channel and glass tile
- Glass and attachment hardware ship separately.
- Standard in clear (CLR) or frosted (FRST) glass.

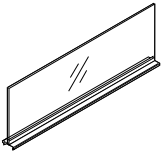
	DESCRIPTION	PRODUCT CODE	LIST PRICE		DIMENSIONS/INCHES		
			Clear	Frosted	H	W	D
 <p>36"W Shown</p>	9" H Panel Mount Privacy Glass w/ Aluminum Trim - 24" Wide	EVPMP24GI9P	193	236	9	24	6mm
	9" H Panel Mount Privacy Glass w/ Aluminum Trim - 30" Wide	EVPMP30GI9P	210	241	9	30	6mm
	9" H Panel Mount Privacy Glass w/ Aluminum Trim - 36" Wide	EVPMP36GI9P	224	246	9	36	6mm
	9" H Panel Mount Privacy Glass w/ Aluminum Trim - 42" Wide	EVPMP42GI9P	234	271	9	42	6mm
	9" H Panel Mount Privacy Glass w/ Aluminum Trim - 48" Wide	EVPMP48GI9P	248	296	9	48	6mm
	9" H Panel Mount Privacy Glass w/ Aluminum Trim - 54" Wide	EVPMP54GI9P	257	320	9	54	6mm
	9" H Panel Mount Privacy Glass w/ Aluminum Trim - 60" Wide	EVPMP60GI9P	265	346	9	60	6mm

**EVPMPXXGIW - 12" H PRIVACY GLASS W/ ALUMINUM TRIM FOR 1" LAMINATE PANEL**

- Attaches on top of Evolve 1" Laminate Panels to add privacy or divide space.
- Privacy Glass is integrated into the aluminum top trim.
- Aluminum trim has rail for accessories.
- Includes aluminum trim with end caps and glass tile
- Glass and attachment hardware ship separately.
- Standard in clear (CLR) or frosted (FRST) glass.

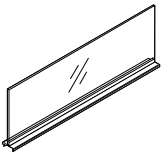
	DESCRIPTION	PRODUCT CODE	LIST PRICE		DIMENSIONS/INCHES		
			Clear	Frosted	H	W	D
 <p>36"W Shown</p>	12" H Privacy Glass w/ Aluminum Trim for 1" Laminate Panel - 24" Wide	EVPMP24GIW	193	236	12	24	1
	12" H Privacy Glass w/ Aluminum Trim for 1" Laminate Panel- 30" Wide	EVPMP30GIW	210	241	12	30	1
	12" H Privacy Glass w/ Aluminum Trim for 1" Laminate Panel - 36" Wide	EVPMP36GIW	224	246	12	36	1
	12" H Privacy Glass w/ Aluminum Trim for 1" Laminate Panel- 42" Wide	EVPMP42GIW	234	271	12	42	1
	12" H Privacy Glass w/ Aluminum Trim for 1" Laminate Panel - 48" Wide	EVPMP48GIW	248	296	12	48	1



# panel connectors



Slotted posts are included with each Variable-Height Corner Post. The height of each slotted post must be specified when ordering a Variable-Height Corner Post. Slotted post height is determined by the height of the connecting panel run.

**Example**

Step 1 Specify base code listed on pricing page.

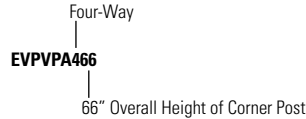

**Segmented Panel**

Step 2 Specify slotted post heights.

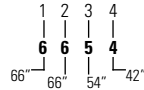

**Note:** To specify height, use the first number of the connecting panel run height dimension.

**Slotted Post Positions**

As illustrated in the example below, start with position 1 and continue clockwise specifying the height of each slotted post.

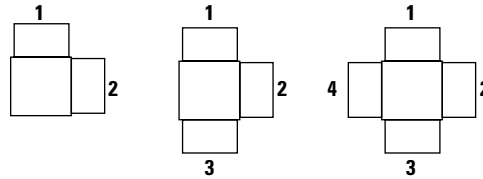

**Sample Configuration - EVPVPA466-6654**

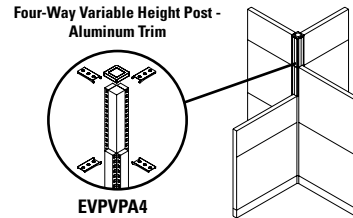

**PANEL CONNECTORS BY TYPE**

- Inline Connector .....93-95**  
 Inline Connector  
 Inline Connector for Light Panels  
 Inline Connector for Beltline Powered Panels  
 Inline Connector for Beltline Powered Light Panels  
 Inline Variable - Height Connector  
 Inline Variable - Height Connector for Light Panels  
 Inline Variable - Height Connector for Beltline Powered Panels  
 Inline Variable - Height Connector for Beltline Powered Light Panels
- End-of-Run ..... 96**  
 End-of-Run Post Kit (Wall Mountable) - Aluminum Trim  
 End-of-Run Post Kit for Light Panels (Wall Mountable) - Aluminum Trim
- Two-Way Post .....97-99**  
 Two-Way Post - Aluminum Trim  
 Two-Way Post for Light Panels - Aluminum Trim  
 Two-Way Post for Beltline Powered Panels - Aluminum Trim  
 Two-Way Post for Beltline Powered Light Panels - Aluminum Trim  
 Two-Way Variable - Height Post - Aluminum Trim  
 Two-Way Variable - Height Post for Light Panels - Aluminum Trim  
 Two-Way Variable - Height Post for Beltline Powered Panels - Aluminum Trim  
 Two-Way Variable - Height Post for Beltline Powered Light Panels - Aluminum Trim

- Three-Way Post .....100-102**  
 Three-Way Post - Aluminum Trim  
 Three-Way Post for Light Panels - Aluminum Trim  
 Three-Way Post for Beltline Powered Panels - Aluminum Trim  
 Three-Way Post for Beltline Powered Light Panels - Aluminum Trim  
 Three-Way Variable - Height Post - Aluminum Trim  
 Three-Way Variable - Height Post for Light Panels - Aluminum Trim  
 Three-Way Variable - Height Post for Beltline Powered Panels - Aluminum Trim  
 Three-Way Variable - Height Post for Beltline Powered Light Panels - Aluminum Trim
- Four-Way Post .....103-105**  
 Four-Way Post  
 Four-Way Post for Light Panels  
 Four-Way Post for Beltline Powered Panels  
 Four-Way Post for Beltline Powered Light Panels  
 Four-Way Variable - Height Post - Aluminum Trim  
 Four-Way Variable - Height Post for Light Panels - Aluminum Trim  
 Four-Way Variable - Height Post for Beltline Powered Panels - Aluminum Trim  
 Four-Way Variable - Height Post for Beltline Powered Light Panels - Aluminum Trim
- One-Way Post .....106-107**  
 One-Way Post - Aluminum Trim  
 One-Way Post for Light Panels - Aluminum Trim  
 One-Way Post for Beltline Powered Panels - Aluminum Trim  
 One-Way Post for Beltline Powered Light Panels - Aluminum Trim

- Inline Two-Way Post .....108-109**  
 Inline Two-Way Post - Aluminum Trim  
 Inline Two-Way Post for Light Panels - Aluminum Trim  
 Inline Two-Way Post for Beltline Powered Panels - Aluminum Trim  
 Inline Two-Way Post for Beltline Powered Light Panels - Aluminum Trim
- 60 Degree .....110-112**  
 Two-Way 60 Degree Post - Aluminum Trim  
 Two-Way 60 Degree Post for Beltline Powered Panels - Aluminum Trim  
 Two-Way 60 Degree Variable - Height Post - Aluminum Trim  
 Two-Way 60 Degree Variable - Height Post for Beltline Powered Panels - Aluminum Trim  
 Three-Way 60 Degree Post  
 Three-Way 60 Degree Post for Beltline Powered Panels  
 Three-Way 60 Degree Variable - Height Post - Aluminum Trim  
 Three-Way 60 Degree Variable - Height Post for Beltline Powered Panels - Aluminum Trim
- 45 Degree ..... 113**  
 Two-Way 45 Degree Post  
 Two-Way 45 Degree Variable - Height Post
- Upmount End of Run .....113-114**  
 Upmount End-of-Run Post Kit (Wall Mountable) - Aluminum  
 Upmount End-of-Run Post Kit For Light Panels (Wall Mountable) - Aluminum  
 Upmount End-of-Run Trim - Aluminum  
 Upmount End-of-Run Trim for Light Panels - Aluminum

- Extension .....115-118**  
 Inline Extension Connector - Slotted  
 End-of-Run Extension Connector - Slotted - Aluminum  
 Two-Way Post Extension - Slotted - Aluminum  
 Three-Way Post Extension - Slotted - Aluminum  
 Four-Way Post Extension - Slotted  
 One-Way Post Extension - Slotted - Aluminum  
 Inline Two-Way Post Extension - Slotted - Aluminum  
 Two-Way 60 Degree Post Extension - Slotted - Aluminum  
 Three Way 60 Degree Post Extension - Slotted - Aluminum  
 One-Way 60 Degree Post Extension - Slotted - Aluminum  
 Two-Way 45 Degree Post Extension - Slotted - Aluminum  
 One-Way 45 Degree Post Extension - Slotted - Aluminum
- Trims .....119-122**  
 Upmount Extension Trim - Aluminum  
 End-of-Run Trim - Aluminum  
 End-of-Run Trim for Light Panels - Aluminum  
 Panel Trim Variable Height - Aluminum  
 Panel Extension Trim - Aluminum  
 Flat Trim - Aluminum  
 Flat Trim for Light Panels - Aluminum  
 Flat Extension Trim - Aluminum  
 Panel Top Trim - Aluminum  
 Panel Top Single Notched Trim - Aluminum  
 Panel Top Double Notched Trim - Aluminum  
 Slot Cover



**EVPIC - INLINE CONNECTOR**

- Connects two panels of equal height in a straight run.
- Provides slotted support for worksurfaces and hang-on storage components.
- Includes one slotted connector with leveling glide and connecting hardware.
- Connectors available without slots, as a special at no upcharge. Contact Customer Support.

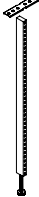
	DESCRIPTION	PRODUCT CODE	LIST PRICE	DIMENSIONS/INCHES		
				H	W	D
	Inline Connector	EVPLIC30	48	30	2	
		EVPLIC42	56	42	2	
		EVPLIC48	59	48	2	
		EVPLIC54	61	54	2	
		EVPLIC66	67	60	2	

**EVPLIC - INLINE CONNECTOR FOR LIGHT PANELS**

- Connects two Light panels of equal height in a straight run.
- Provides slotted support for worksurfaces and hang-on storage components.
- Includes one slotted connector with leveling glide, decorative sleeve, and connecting hardware.
- Decorative sleeve available in Evolve standard colors only.
- Connectors available without slots as a special at no upcharge. Contact Customer Support.

	DESCRIPTION	PRODUCT CODE	LIST PRICE	DIMENSIONS/INCHES		
				H	W	D
	Inline Connector for Light Panels	EVPLIC30	48	30	2	
		EVPLIC42	56	42	2	
		EVPLIC48	59	48	2	
		EVPLIC54	61	54	2	
		EVPLIC66	67	66	2	

**EVPBIC - INLINE CONNECTOR FOR BELTLINE POWERED PANELS**

- Connects two Beltline Powered panels of equal height in a straight run.
- Provides slotted support for worksurfaces and hang-on storage components.
- Includes one slotted connector with leveling glide and connecting hardware.
- Connectors available without slots, as a special at no upcharge. Contact Customer Support.

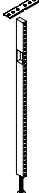
	DESCRIPTION	PRODUCT CODE	LIST PRICE	DIMENSIONS/INCHES		
				H	W	D
	Inline Connector for Beltline Powered Panels	EVPBIC42	56	42	2	
		EVPBIC54	61	54	2	
		EVPBIC66	67	66	2	



## EVPBLC - INLINE CONNECTOR FOR BELTLINE POWERED LIGHT PANELS

- Connects two Beltline Powered Light panels of equal height in a straight run.
- Provides slotted support for worksurfaces and hang-on storage components.
- Includes one slotted connector with leveling glide, decorative sleeve, and connecting hardware.
- Decorative sleeve available in Evolve standard colors only.
- Connectors available without slots as a special at no upcharge.

	DESCRIPTION	PRODUCT CODE	LIST PRICE	DIMENSIONS/INCHES		
				H	W	D
	Inline Connector for Beltline Powered Light Panels	EVPBLC42	56	42	2	
		EVPBLC54	61	54	2	
		EVPBLC66	67	66	2	

## EVPVC - INLINE VARIABLE - HEIGHT CONNECTOR

- Connects two panels of differing height in a straight run.
- Connector must reference taller panel.
- Can be used for any variation of panel heights.
- Variable-height trim must be ordered separately (see EVPTVAXX)
- Provides slotted support for worksurfaces and hang-on storage components.
- Includes one slotted connector with leveling glide and connecting hardware.
- Connectors available without slots, as a special at no upcharge. Contact Customer Support.
- Please see page 92 on how to specify.

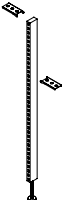
	DESCRIPTION	PRODUCT CODE	LIST PRICE	DIMENSIONS/INCHES		
				H	W	D
	Inline Variable - Height Connector	EVPVC42	61	42	2	
		EVPVC48	62	48	2	
		EVPVC54	63	54	2	
		EVPVC66	68	66	2	

## EVPLVC - INLINE VARIABLE - HEIGHT CONNECTOR FOR LIGHT PANELS

- Connects two Light panels of differing height in a straight run.
- Connector must reference taller panel.
- Can be used on any variation of panel heights.
- Variable-height trim must be ordered separately (see EVPLVAXX)
- Provides slotted support for worksurfaces and hang-on storage components.
- Includes one slotted connector with leveling glide, decorative sleeve, and connecting hardware.
- Decorative sleeve available in Evolve standard colors only.
- Connectors available without slots, as a special at no upcharge. Contact Customer Support.
- Please see page 92 on how to specify.

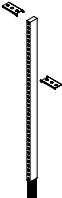
	DESCRIPTION	PRODUCT CODE	LIST PRICE	DIMENSIONS/INCHES		
				H	W	D
	Inline Variable - Height Connector for Light Panels	EVPLVC42	61	42	2	
		EVPLVC48	62	48	2	
		EVPLVC54	63	54	2	
		EVPLVC66	68	66	2	



**EVPBVC - INLINE VARIABLE - HEIGHT CONNECTOR FOR BELTLINE POWERED PANELS**

- Connects two Beltline Powered panels of differing height in a straight run.
- Connector must reference taller panel.
- Can be used for any variation of panel heights.
- Variable-height trim must be ordered separately (see EVPTVAXX)
- Provides slotted support for worksurfaces and hang-on storage components.
- Includes one slotted connector with leveling glide and connecting hardware.
- Connectors available without slots, as a special at no upcharge. Contact Customer Support.
- Please see page 92 on how to specify.

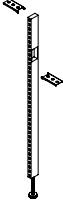
	DESCRIPTION	PRODUCT CODE	LIST PRICE	DIMENSIONS/INCHES		
				H	W	D
	Inline Variable - Height Connector for Beltline Powered Panels	EVPBVC54	63	54	2	
		EVPBVC66	68	66	2	

**EVPBLC - INLINE VARIABLE - HEIGHT CONNECTOR FOR BELTLINE POWERED LIGHT PANELS**

- Connects two Beltline Powered Light panels of differing height in a straight run.
- Connector must reference taller panel.
- Can be used for any variation of panel heights.
- Variable-height trim must be ordered separately (see EVPLTVAXX)
- Provides slotted support for worksurfaces and hang-on storage components.
- Includes one slotted connector with leveling glide, decorative sleeve, and connecting hardware.
- Decorative sleeve available in Evolve standard colors only.
- Connectors available without slots, as a special at no upcharge. Contact Customer Support.
- Please see page 92 on how to specify.

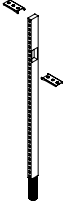
	DESCRIPTION	PRODUCT CODE	LIST PRICE	DIMENSIONS/INCHES		
				H	W	D
	Inline Variable - Height Connector for Beltline Powered Light Panels	EVPBLC54	63	54	2	
		EVPBLC66	68	66	2	

**EVPERA - END-OF-RUN POST KIT (WALL MOUNTABLE) - ALUMINUM TRIM**

- Connects at the end of a panel run and can be used to attach a panel to a fixed wall.
- Adds 1" to the width of the panel run.
- Provides slotted support for worksurfaces and hang-on storage components.
- Includes one slotted connector with leveling glide, connecting hardware and trim kit.
- Can be attached to face of another panel to provide off-modular panel connection.
- Connectors available without slots, as a special at no upcharge. Contact Customer Support.

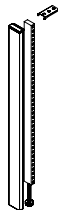
	DESCRIPTION	PRODUCT CODE	LIST PRICE	DIMENSIONS/INCHES		
				H	W	D
	End-of-Run Post Kit (Wall Mountable) - Aluminum Trim	EVPERA30	59	30	2 7/8	
		EVPERA42	67	42	2 7/8	
		EVPERA48	71	48	2 7/8	
		EVPERA54	81	54	2 7/8	
		EVPERA66	90	66	2 7/8	

**EVPLERA - END-OF-RUN POST KIT FOR LIGHT PANELS (WALL MOUNTABLE) - ALUMINUM TRIM**

- Connects at the end of a Light panel run and can be used to attach a panel to a fixed wall.
- Adds 1" to the width of the panel run.
- Provides slotted support for worksurfaces and hang-on storage components.
- Includes one slotted connector with leveling glide, connecting hardware, decorative sleeve and trim kit.
- Can be attached to face of another panel to provide off-modular panel connection.
- Connectors available without slots, as a special at no upcharge. Contact Customer Support.

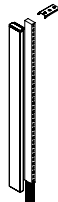
	DESCRIPTION	PRODUCT CODE	LIST PRICE		DIMENSIONS/INCHES		
			Gr1	Gr2	H	W	D
	End-of Run Post Kit for Light Panels (Wall Mountable) - Aluminum	EVPLERA30	59		30	2 7/8	
		EVPLERA42	67		42	2 7/8	
		EVPLERA48	71		48	2 7/8	
		EVPLERA54	81		54	2 7/8	
		EVPLERA66	90		66	2 7/8	



**EVPCPA2 - TWO-WAY POST - ALUMINUM TRIM**

- Connects two panels of equal height in a 90 degree configuration.
- Post and connecting hardware adds 3.25" to the panel run.
- Provides slotted support for worksurfaces and hang-on storage components.
- Includes one post, two slotted connectors with leveling glides, connecting hardware and trim kit.
- Connectors available without slots, as a special at no upcharge. Contact Customer Support.

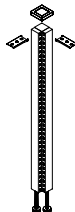
	DESCRIPTION	PRODUCT CODE	LIST PRICE	DIMENSIONS/INCHES		
				H	W	D
	Two-Way Post - Aluminum Trim	EVPCPA230	111	30	2 7/8	
		EVPCPA242	139	42	2 7/8	
		EVPCPA248	149	48	2 7/8	
		EVPCPA254	172	54	2 7/8	
		EVPCPA266	204	66	2 7/8	

**EVPLCPA2 - TWO-WAY POST FOR LIGHT PANELS - ALUMINUM TRIM**

- Connects two Light Panels of equal height in a 90 degree configuration.
- Post and connecting hardware adds 3.25" to the panel run.
- Provides slotted support for worksurfaces and hang-on storage components.
- Includes one post, two slotted connectors with leveling glides, decorative sleeve, connecting hardware and trim kit.
- Decorative sleeve available in Evolve standard colors only.
- Connectors available without slots, as a special at no upcharge. Contact Customer Support.

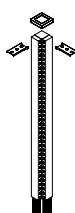
	DESCRIPTION	PRODUCT CODE	LIST PRICE	DIMENSIONS/INCHES		
				H	W	D
	Two-Way Post for Light Panels - Aluminum Trim	EVPLCPA230	111	30	2 7/8	
		EVPLCPA242	139	42	2 7/8	
		EVPLCPA248	149	48	2 7/8	
		EVPLCPA254	172	54	2 7/8	
		EVPLCPA266	204	66	2 7/8	

**EVBCPA2 - TWO-WAY POST FOR BELTLINE POWERED PANELS - ALUMINUM TRIM**

- Connects two Beltline Powered panels of equal height in a 90 degree configuration.
- Post and connecting hardware adds 3.25" to the panel run.
- Provides slotted support for worksurfaces and hang-on storage components.
- Includes one post, two slotted connectors with leveling glides, connecting hardware and trim kit.
- Connectors available without slots, as a special at no upcharge. Contact Customer Support.

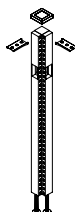
	DESCRIPTION	PRODUCT CODE	LIST PRICE	DIMENSIONS/INCHES		
				H	W	D
	Two-Way Post for Beltline Powered Panels - Aluminum Trim	EVBCPA242	139	42	2 7/8	
		EVBCPA254	172	54	2 7/8	
		EVBCPA266	204	66	2 7/8	

**EVPBLCPA2 - TWO-WAY POST FOR BELTLINE POWERED LIGHT PANELS - ALUMINUM TRIM**

- Connects two Beltline Powered Light panels of equal height in a 90 degree configuration.
- Post and connecting hardware adds 3.25" to the panel run.
- Provides slotted support for worksurfaces and hang-on storage components.
- Includes one post, two slotted connectors with leveling glides, decorative sleeve, connecting hardware and trim kit.
- Decorative sleeve available in Evolve standard colors only.
- Connectors available without slots, as a special at no upcharge. Contact Customer Support.

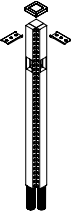
	DESCRIPTION	PRODUCT CODE	LIST PRICE	DIMENSIONS/INCHES		
				H	W	D
	Two-Way Post for Beltline	EVPBLCPA242	139	42	2 7/8	
	Powered Light Panels - Aluminum Trim	EVPBLCPA254	172	54	2 7/8	
		EVPBLCPA266	204	66	2 7/8	

**EVPVPA2 - TWO-WAY VARIABLE - HEIGHT POST - ALUMINIM TRIM**

- Connects two panels of differing height in a 90 degree configuration.
- Connector must reference taller panel.
- Post and connecting hardware adds 3.25" to the panel run.
- Provides slotted support for worksurfaces and hang-on storage components.
- Includes one post, two slotted connectors with leveling glides, connecting hardware and trim kit.
- Connectors available without slots as a special at no upcharge. Contact Customer Support
- Please see page 92 on how to specify.

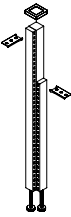
	DESCRIPTION	PRODUCT CODE	LIST PRICE	DIMENSIONS/INCHES		
				H	W	D
	Two-Way Variable - Height Post - Aluminum Trim	EVPVPA242	139	42	2 7/8	
		EVPVPA248	156	48	2 7/8	
		EVPVPA254	172	54	2 7/8	
		EVPVPA266	204	66	2 7/8	

**EVPLVPA2 - TWO-WAY VARIABLE - HEIGHT POST FOR LIGHT PANELS - ALUMINUM TRIM**

- Connects two Light panels of differing height in a 90 degree configuration.
- Connector must reference taller panel.
- Post and connecting hardware adds 3.25" to the panel run.
- Provides slotted support for worksurfaces and hang-on storage components.
- Includes one post, two slotted connectors with leveling glides, decorative sleeve, connecting hardware and trim kit.
- Decorative sleeve available in Evolve standard colors only.
- Connectors available without slots, as a special at no upcharge. Contact Customer Support.
- Please see page 92 on how to specify.

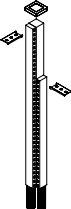
	DESCRIPTION	PRODUCT CODE	LIST PRICE	DIMENSIONS/INCHES		
				H	W	D
	Two-Way Variable - Height Post for Light Panels - Aluminum	EVPLVPA242	139	42	2 7/8	
		EVPLVPA248	156	48	2 7/8	
		EVPLVPA254	172	54	2 7/8	
		EVPLVPA266	204	66	2 7/8	



**EVPBVPA2 - TWO-WAY VARIABLE - HEIGHT POST FOR BELTLINE POWERED PANELS - ALUMINIM TRIM**

- Connects two Beltline Powered panels of differing height in a 90 degree configuration.
- Connector must reference taller panel.
- Post and connecting hardware adds 3.25" to the panel run.
- Provides slotted support for worksurfaces and hang-on storage components.
- Includes one post, two slotted connectors with leveling glides, connecting hardware and trim kit.
- Connectors available without slots, as a special at no upcharge. Contact Customer Support.
- Please see page 92 on how to specify.

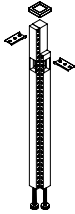
	DESCRIPTION	PRODUCT CODE	LIST PRICE	DIMENSIONS/INCHES		
				H	W	D
	Two-Way Variable - Height Post for Beltline Powered Panels - Aluminum Trim	EVPBVPA254	172	54	2 7/8	
		EVPBVPA266	204	66	2 7/8	

**EVPBLVPA2 - TWO-WAY VARIABLE - HEIGHT POST FOR BELTLINE POWER LIGHT PANELS - ALUMINUM TRIM**

- Connects two Beltline Powered Light panels of differing height in a 90 degree configuration.
- Connector must reference taller panel.
- Post and connecting hardware adds 3.25" to the panel run.
- Provides slotted support for worksurfaces and hang-on storage components.
- Includes one post, two slotted connectors with leveling glides, decorative sleeve, connecting hardware and trim kit.
- Decorative sleeve available in Evolve standard colors only.
- Connectors available without slots, as a special at no upcharge. Contact Customer Support.
- Please see page 92 on how to specify.

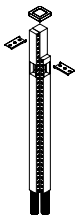
	DESCRIPTION	PRODUCT CODE	LIST PRICE	DIMENSIONS/INCHES		
				H	W	D
	Two-Way Variable - Height Corner Post for Beltline Powered Light Panels - Aluminum Trim	EVPBLVPA254	172	54	2 7/8	
		EVPBLVPA266	204	66	2 7/8	

**EVPCPA3 - THREE-WAY POST - ALUMINUM TRIM**

- Connects three panels of equal height in a “T” configuration.
- Post and connecting hardware adds 3.25” to the panel run.
- Provides slotted support for worksurfaces and hang-on storage components.
- Includes one post, three slotted connectors with leveling glides, connecting hardware and trim kit.
- Connectors available without slots, as a special at no upcharge. Contact Customer Support.

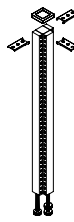
DESCRIPTION	PRODUCT CODE	LIST PRICE	DIMENSIONS/INCHES		
			H	W	D
 Three-Way Post - Aluminum Trim	EVPCPA330	138	30	2 7/8	
	EVPCPA342	185	42	2 7/8	
	EVPCPA348	204	48	2 7/8	
	EVPCPA354	224	54	2 7/8	
	EVPCPA366	265	66	2 7/8	

**EVPLCPA3 - THREE-WAY POST FOR LIGHT PANELS - ALUMINUM TRIM**

- Connects three Light panels of equal height in a “T” configuration.
- Post and connecting hardware adds 3.25” to the panel run.
- Provides slotted support for worksurfaces and hang-on storage components.
- Includes one post, three slotted connectors with leveling glides, decorative sleeve, connecting hardware and trim kit.
- Decorative sleeve available in Evolve standard colors only.
- Connectors available without slots, as a special at no upcharge. Contact Customer Support.

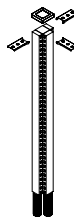
DESCRIPTION	PRODUCT CODE	LIST PRICE	DIMENSIONS/INCHES		
			H	W	D
 Three-Way Post for Light Panels - Aluminum	EVPLCPA330	138	30	2 7/8	
	EVPLCPA342	185	42	2 7/8	
	EVPLCPA348	204	48	2 7/8	
	EVPLCPA354	224	54	2 7/8	
	EVPLCPA366	265	66	2 7/8	

**EVPBCPA3 - THREE-WAY POST FOR BELTLINE POWERED PANELS - ALUMINUM TRIM**

- Connects three Beltline Powered panels of equal height in a “T” configuration.
- Post and connecting hardware adds 3.25” to the panel run.
- Provides slotted support for worksurfaces and hang-on storage components.
- Includes one post, three slotted connectors with leveling glides, connecting hardware and trim kit.
- Connectors available without slots, as a special at no upcharge. Contact Customer Support.

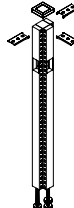
DESCRIPTION	PRODUCT CODE	LIST PRICE	DIMENSIONS/INCHES		
			H	W	D
 Three-Way Post for Beltline Powered Panels - Aluminum Trim	EVPBCPA342	185	42	2 7/8	
	EVPBCPA354	224	54	2 7/8	
	EVPBCPA366	265	66	2 7/8	



**EVPLCPA3 - THREE-WAY POST FOR BELTLINE POWERED LIGHT PANELS - ALUMINUM TRIM**

- Connects three Beltline Powered Light panels of equal height in a "T" configuration.
- Post and connecting hardware adds 3.25" to the panel run.
- Provides slotted support for worksurfaces and hang-on storage components.
- Includes one post, three slotted connectors with leveling glides, decorative sleeve, connecting hardware and trim kit.
- Decorative sleeve available in Evolve standard colors only.
- Connectors available without slots, as a special at no upcharge. Contact Customer Support.

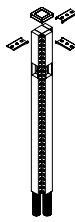
DESCRIPTION	PRODUCT CODE	LIST PRICE	DIMENSIONS/INCHES		
			H	W	D
 Three-Way Post for Beltline Powered Light Panels - Aluminum Trim	EVPLCPA342	185	42	2 7/8	
	EVPLCPA354	224	54	2 7/8	
	EVPLCPA366	265	66	2 7/8	

**EVVPVA3 - THREE-WAY VARIABLE - HEIGHT POST - ALUMINUM TRIM**

- Connects three panels of differing height in a "T" configuration.
- Connector must reference taller panel.
- Post and connecting hardware adds 3.25" to the panel run.
- Provides slotted support for worksurfaces and hang-on storage components.
- Includes one post, three slotted connectors with leveling glides, connecting hardware and trim kit.
- Connectors available without slots, as a special at no upcharge. Contact Customer Support.
- Please see page 92 on how to specify.

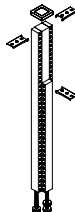
DESCRIPTION	PRODUCT CODE	LIST PRICE	DIMENSIONS/INCHES		
			H	W	D
 Three-Way Variable - Height Post - Aluminum Trim	EVVPVA342	185	42	2 7/8	
	EVVPVA348	204	48	2 7/8	
	EVVPVA354	224	54	2 7/8	
	EVVPVA366	265	66	2 7/8	

**EVPLVPA3 - THREE-WAY VARIABLE - HEIGHT POST FOR LIGHT PANELS - ALUMINUM TRIM**

- Connects three Light panels of differing height in a "T" configuration.
- Connector must reference taller panel.
- Post and connecting hardware adds 3.25" to the panel run.
- Provides slotted support for worksurfaces and hang-on storage components.
- Includes one post, three slotted connectors with leveling glides, decorative sleeve, connecting hardware and trim kit.
- Decorative sleeve available in Evolve standard colors only.
- Connectors available without slots, as a special at no upcharge. Contact Customer Support.
- Please see page 92 on how to specify.

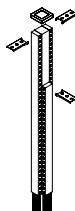
DESCRIPTION	PRODUCT CODE	LIST PRICE	DIMENSIONS/INCHES		
			H	W	D
 Three-Way Variable - Height Post for Light Panels - Aluminum Trim	EVPLVPA342	201	42	2 7/8	
	EVPLVPA348	204	48	2 7/8	
	EVPLVPA354	224	54	2 7/8	
	EVPLVPA366	265	66	2 7/8	



**EVPBVPA3 - THREE-WAY VARIABLE - HEIGHT POST FOR BELTLINE POWERED PANELS - ALUMINUM TRIM**

- Connects three Beltline Powered panels of differing height in a “T” configuration.
- Connector must reference taller panel.
- Post and connecting hardware adds 3.25” to the panel run.
- Provides slotted support for worksurfaces and hang-on storage components.
- Includes one post, three slotted connectors with leveling glides, connecting hardware and trim kit.
- Connectors available without slots, as a special at no upcharge. Contact Customer Support.
- Please see page 92 on how to specify.

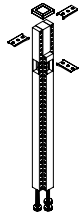
	DESCRIPTION	PRODUCT CODE	LIST PRICE	DIMENSIONS/INCHES		
				H	W	D
	Three-Way Variable - Height Post for Beltline Powered Panels - Aluminum Trim	EVPBVPA354	224	54	2 7/8	
		EVPBVPA366	265	66	2 7/8	

**EVPBLVPA3 - THREE-WAY VARIABLE - HEIGHT POST FOR BELTLINE POWERED LIGHT PANELS - ALUMINUM TRIM**

- Connects three Beltline Powered Light panels of differing height in a “T” configuration.
- Connector must reference taller panel.
- Post and connecting hardware adds 3.25” to the panel run.
- Provides slotted support for worksurfaces and hang-on storage components.
- Includes one post, three slotted connectors with leveling glides, decorative sleeve, connecting hardware and trim kit.
- Decorative sleeve available in Evolve standard colors only.
- Connectors available without slots, as a special at no upcharge. Contact Customer Support.
- Please see page 92 on how to specify.

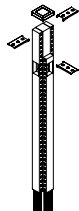
	DESCRIPTION	PRODUCT CODE	LIST PRICE	DIMENSIONS/INCHES		
				H	W	D
	Three-Way Variable - Height Post for Beltline Powered Light Panels - Aluminum Trim	EVPBLVPA354	224	54	2 7/8	
		EVPBLVPA366	265	66	2 7/8	



**EVPCP4 - FOUR-WAY POST**

- Connects four panels of equal height in a “+” configuration.
- Post and connecting hardware adds 3.25” to the panel run.
- Provides slotted support for worksurfaces and hang-on storage components.
- Includes one post, four slotted connectors with leveling glides and connecting hardware.
- Connectors available without slots, as a special at no upcharge. Contact Customer Support.

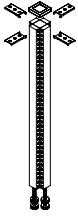
	DESCRIPTION	PRODUCT CODE	LIST PRICE	DIMENSIONS/INCHES		
				H	W	D
	Four-Way Post	EVPCP430	170	30	2 7/8	
		EVPCP442	218	42	2 7/8	
		EVPCP448	241	48	2 7/8	
		EVPCP454	263	54	2 7/8	
		EVPCP466	308	66	2 7/8	

**EVPLCP4 - FOUR-WAY POST FOR LIGHT PANELS**

- Connects four Light panels of equal height in a “+” configuration.
- Post and connecting hardware adds 3.25” to the panel run.
- Provides slotted support for worksurfaces and hang-on storage components.
- Includes one post, four slotted connectors with leveling glides, decorative sleeve and connecting hardware.
- Decorative sleeve available in Evolve standard colors only.
- Connectors available without slots, as a special at no upcharge. Contact Customer Support.

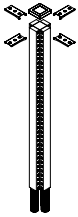
	DESCRIPTION	PRODUCT CODE	LIST PRICE	DIMENSIONS/INCHES		
				H	W	D
	Four-Way Post for Light Panels	EVPLCP430	170	30	2 7/8	
		EVPLCP442	218	42	2 7/8	
		EVPLCP448	241	48	2 7/8	
		EVPLCP454	263	54	2 7/8	
		EVPLCP466	308	66	2 7/8	

**EVBCP4 - FOUR-WAY POST FOR BELTLINE POWERED PANELS**

- Connects four Beltline Powered panels of equal height in a “+” configuration.
- Post and connecting hardware adds 3.25” to the panel run.
- Provides slotted support for worksurfaces and hang-on storage components.
- Includes one post, four slotted connectors with leveling glides and connecting hardware.
- Connectors available without slots, as a special at no upcharge. Contact Customer Support.

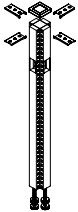
	DESCRIPTION	PRODUCT CODE	LIST PRICE	DIMENSIONS/INCHES		
				H	W	D
	Four-Way Post for Beltline Powered Panels	EVBCP442	218	42	2 7/8	
		EVBCP454	263	54	2 7/8	
		EVBCP466	308	66	2 7/8	

**EVPBLC4 - FOUR-WAY POST FOR BELTLINE POWERED LIGHT PANELS**

- Connects four Beltline Powered Light panels of equal height in a “+” configuration.
- Post and connecting hardware adds 3.25” to the panel run.
- Provides slotted support for worksurfaces and hang-on storage components.
- Includes one post, four slotted connectors with leveling glides, decorative sleeve and connecting hardware.
- Decorative sleeve available in Evolve standard colors only.
- Connectors available without slots, as a special at no upcharge. Contact Customer Support.

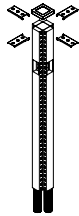
DESCRIPTION	PRODUCT CODE	LIST PRICE	DIMENSIONS/INCHES		
			H	W	D
 Four-Way Post for Beltline Powered Light Panels	EVPBLC442	218	42	2 7/8	
	EVPBLC454	263	54	2 7/8	
	EVPBLC466	308	66	2 7/8	

**EVPVPA4 - FOUR-WAY VARIABLE - HEIGHT POST - ALUMINUM TRIM**

- Connects four panels of differing heights in a “+” configuration.
- Connector must reference taller panel.
- Post and connecting hardware adds 3.25” to the panel run.
- Provides slotted support for worksurfaces and hang-on storage components.
- Includes one post, four slotted connectors with leveling glides, connecting hardware and trim kit.
- Connectors available without slots, as a special at no upcharge. Contact Customer Support.
- Please see page 92 on how to specify.

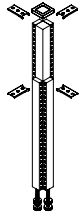
DESCRIPTION	PRODUCT CODE	LIST PRICE	DIMENSIONS/INCHES		
			H	W	D
 Four-Way Variable - Height Corner Post - Aluminum Trim	EVPVPA442	218	42	2 7/8	
	EVPVPA448	241	48	2 7/8	
	EVPVPA454	263	54	2 7/8	
	EVPVPA466	308	66	2 7/8	

**EVPLVPA4 - FOUR-WAY VARIABLE - HEIGHT POST FOR LIGHT PANELS - ALUMINUM TRIM**

- Connects four Light panels of differing heights in a “+” configuration.
- Connector must reference taller panel.
- Post and connecting hardware adds 3.25” to the panel run.
- Provides slotted support for worksurfaces and hang-on storage components.
- Includes one post, four slotted connectors with leveling glides, decorative sleeve, connecting hardware and trim kit.
- Decorative sleeve available in Evolve standard colors only.
- Connectors available without slots, as a special at no upcharge. Contact Customer Support.
- Please see page 92 on how to specify.

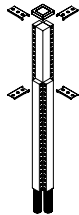
DESCRIPTION	PRODUCT CODE	LIST PRICE	DIMENSIONS/INCHES		
			H	W	D
 Four-Way Variable - Height Post for Light Panels - Aluminum Trim	EVPLVPA442	231	42	2 7/8	
	EVPLVPA448	241	48	2 7/8	
	EVPLVPA454	263	54	2 7/8	
	EVPLVPA466	308	66	2 7/8	



**EVPBVPA4 - FOUR-WAY VARIABLE - HEIGHT POST FOR BELTLINE POWERED PANELS - ALUMINUM TRIM**

- Connects four Beltline Powered panels of differing heights in an “+” configuration.
- Connector must reference taller panel.
- Post and connecting hardware adds 3.25” to the panel run.
- Provides slotted support for worksurfaces and hang-on storage components.
- Includes one post, four slotted connectors with leveling glides, connecting hardware and trim kit.
- Connectors available without slots, as a special at no upcharge. Contact Customer Support.
- Please see page 92 on how to specify.

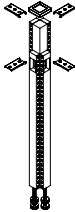
	DESCRIPTION	PRODUCT CODE	LIST PRICE	DIMENSIONS/INCHES		
				H	W	D
	Four-Way Variable - Height Post for Beltline Powered Panels - Aluminum Trim	EVPBVPA454	263	54	2 7/8	
		EVPBVPA466	308	66	2 7/8	

**EVPBLVPA4 - FOUR-WAY VARIABLE - HEIGHT POST FOR BELTLINE POWERED LIGHT PANELS – ALUMINUM TRIM**

- Connects four Beltline Powered Light panels of differing heights in a “+” configuration.
- Connector must reference taller panel.
- Post and connecting hardware adds 3.25” to the panel run.
- Provides slotted support for worksurfaces and hang-on storage components.
- Includes one post, four slotted connectors with leveling glides, decorative sleeve, connecting hardware and trim kit.
- Decorative sleeve available in Evolve standard colors only.
- Connectors available without slots, as a special at no upcharge. Contact Customer Support.
- Please see page 92 on how to specify.

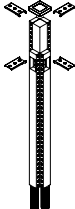
	DESCRIPTION	PRODUCT CODE	LIST PRICE	DIMENSIONS/INCHES		
				H	W	D
	Four-Way Variable - Height Post for Beltline Power Light Panels - Aluminum Trim	EVPBLVPA454	263	54	2 7/8	
		EVPBLVPA466	308	66	2 7/8	

**EVPCPA1 - ONE-WAY POST - ALUMINUM TRIM**

- Connects at the end of a panel run in place of an EVPERA – End-of-Run Post Kit.
- Should not be used to attach a panel to a fixed wall.
- Post and connecting hardware adds 3.25" to the panel run.
- Provides slotted support for worksurfaces and hang-on storage components.
- Includes one post and one slotted connector with a leveling glide, connecting hardware and trim kit.
- Connectors available without slots, as a special at no upcharge. Contact Customer Support.

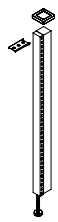
	DESCRIPTION	PRODUCT CODE	LIST PRICE	DIMENSIONS/INCHES		
				H	W	D
	One-Way Post - Aluminum Trim	EVPCPA130	78	30	2 7/8	
		EVPCPA142	90	42	2 7/8	
		EVPCPA148	105	48	2 7/8	
		EVPCPA154	121	54	2 7/8	
		EVPCPA166	149	66	2 7/8	

**EVPLCPA1 - ONE-WAY POST FOR LIGHT PANELS - ALUMINUM TRIM**

- Connects at the end of a Light panel run in place of an EVPERA – End-of-Run Post Kit.
- Should not be used to attach a panel to a fixed wall.
- Post and connecting hardware adds 3.25" to the panel run.
- Provides slotted support for worksurfaces and hang-on storage components.
- Includes one post and one slotted connector with a leveling glide, connecting hardware and trim kit.
- Decorative sleeve available in Evolve standard colors only.
- Connectors available without slots, as a special at no upcharge. Contact Customer Support.

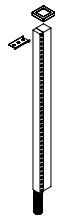
	DESCRIPTION	PRODUCT CODE	LIST PRICE	DIMENSIONS/INCHES		
				H	W	D
	One-Way Post for Light Panels - Aluminum	EVPLCPA130	78	30	2 7/8	
		EVPLCPA142	90	42	2 7/8	
		EVPLCPA148	105	48	2 7/8	
		EVPLCPA154	121	54	2 7/8	
		EVPLCPA166	149	66	2 7/8	



**EVPBCPA1 - ONE-WAY POST FOR BELTLINE POWERED PANELS - ALUMINUM TRIM**

- Connects at the end of a Beltline Powered panel run in place of an EVPERA – End-of-Run Post Kit.
- Should not be used to attach a panel to a fixed wall.
- Post and connecting hardware adds 3.25" to the panel run.
- Provides slotted support for worksurfaces and hang-on storage components.
- Includes one post and one slotted connector with a leveling glide, connecting hardware and trim kit.
- Connectors available without slots, as a special at no upcharge. Contact Customer Support.

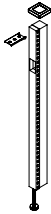
	DESCRIPTION	PRODUCT CODE	LIST PRICE	DIMENSIONS/INCHES		
				H	W	D
	One-Way Post for Beltline Powered Panels -	EVPBCPA142	90	42	2 7/8	
	Aluminum Trim	EVPBCPA154	121	54	2 7/8	
		EVPBCPA166	149	66	2 7/8	

**EVPBLCPA1 - ONE-WAY POST FOR BELTLINE POWERED LIGHT PANELS - ALUMINUM TRIM**

- Connects at the end of a Beltline Powered Light panel run in place of an EVPERA – End-of-Run Post Kit.
- Should not be used to attach a panel to a fixed wall.
- Post and connecting hardware adds 3.25" to the panel run.
- Provides slotted support for worksurfaces and hang-on storage components.
- Includes one post and one slotted connector with a leveling glide, connecting hardware and trim kit.
- Decorative sleeve available in Evolve standard colors only.
- Connectors available without slots, as a special at no upcharge. Contact Customer Support.

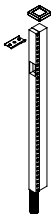
	DESCRIPTION	PRODUCT CODE	LIST PRICE	DIMENSIONS/INCHES		
				H	W	D
	One-Way Post for Beltline Powered	EVPBLCPA142	90	42	2 7/8	
	Light Panels - Aluminum Trim	EVPBLCPA154	121	54	2 7/8	
		EVPBLCPA166	149	66	2 7/8	

**EVPIPA2 - INLINE TWO-WAY POST - ALUMINUM TRIM**

- Connects two panels of equal height in a straight line in place of EVPIC – In-Line Connector.
- Post and connecting hardware adds 3.25" to the panel run.
- Provides slotted support for worksurfaces and hang-on storage components.
- Includes one post, two slotted connectors with leveling glides, connecting hardware and trim kit.
- Connectors available without slots, as a special at no upcharge. Contact Customer Support.

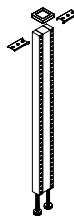
	DESCRIPTION	PRODUCT CODE	LIST PRICE	DIMENSIONS/INCHES		
				H	W	D
	Inline Two-Way Post - Aluminum Trim	EVPIPA230	109	30	2 7/8	
		EVPIPA242	136	42	2 7/8	
		EVPIPA248	150	48	2 7/8	
		EVPIPA254	163	54	2 7/8	
		EVPIPA266	195	66	2 7/8	

**EVPLIPA2 - INLINE TWO-WAY POST FOR LIGHT PANELS - ALUMINUM TRIM**

- Connects two Light panels of equal height in a straight line in place of EVPIC – In-Line Connector.
- Post and connecting hardware adds 3.25" to the Light panel run.
- Provides slotted support for worksurfaces and hang-on storage components.
- Includes one post, two slotted connectors with leveling glides, decorative sleeve, connecting hardware and trim kit.
- Decorative sleeve available in Evolve standard colors only.
- Connectors available without slots, as a special at no upcharge. Contact Customer Support.

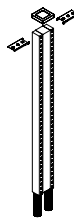
	DESCRIPTION	PRODUCT CODE	LIST PRICE	DIMENSIONS/INCHES		
				H	W	D
	Inline Two-Way Post for Light Panels - Aluminum	EVPLIPA230	109	30	2 7/8	
		EVPLIPA242	136	42	2 7/8	
		EVPLIPA248	150	48	2 7/8	
		EVPLIPA254	163	54	2 7/8	
		EVPLIPA266	195	66	2 7/8	



**EVPBIPA2 - INLINE TWO-WAY POST FOR BELTLINE POWERED PANELS - ALUMINUM TRIM**

- Connects two Beltline Powered panels of equal height in between a post in a straight line in place of EVPIC – In-Line Connector.
- Post and connecting hardware adds 3.25" to the panel run.
- Provides slotted support for worksurfaces and hang-on storage components.
- Includes one post, two slotted connectors with leveling glides, connecting hardware and trim kit.
- Connectors available without slots, as a special at no upcharge. Contact Customer Support.

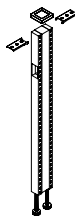
DESCRIPTION	PRODUCT CODE	LIST PRICE	DIMENSIONS/INCHES		
			H	W	D
 Inline Two-Way Post for Beltline Powered Panels - Aluminum Trim	EVPBIPA242	136	42	2 7/8	
	EVPBIPA254	163	54	2 7/8	
	EVPBIPA266	195	66	2 7/8	

**EVPBLIPA2 - INLINE TWO-WAY POST FOR BELTLINE POWERED LIGHT PANELS - ALUMINUM TRIM**

- Connects two Beltline Powered Light panels of equal height in a straight line in place of EVPIC – In-Line Connector.
- Post and connecting hardware adds 3.25" to the Light panel run.
- Provides slotted support for worksurfaces and hang-on storage components.
- Includes one post, two slotted connectors with leveling glides, decorative sleeve, connecting hardware and trim kit.
- Decorative sleeve available in Evolve standard colors only.
- Connectors available without slots, as a special at no upcharge. Contact Customer Support.

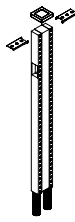
DESCRIPTION	PRODUCT CODE	LIST PRICE	DIMENSIONS/INCHES		
			H	W	D
 Inline Two-Way Post for Beltline Powered Light Panels - Aluminum Trim	EVPBLIPA242	136	42	2 7/8	
	EVPBLIPA254	163	54	2 7/8	
	EVPBLIPA266	195	66	2 7/8	



## EVP6PA2 - TWO-WAY 60 DEGREE POST - ALUMINUM TRIM

- Connects two panels of equal height in a 120 degree configuration.
- Provides slotted support for worksurfaces and hang-on storage components.
- Includes one 60 degree post, two slotted connectors with leveling glides, connecting hardware and trim kit.
- Connectors available without slots as a special at no upcharge. Contact Customer Service.

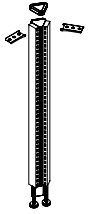
	DESCRIPTION	PRODUCT CODE	LIST PRICE	DIMENSIONS/INCHES		
				H	W	D
	Two-Way 60 Degree Post - Aluminum	EVP6PA230	111	30	3.65	
		EVP6PA242	138	42	3.65	
		EVP6PA248	149	48	3.65	
		EVP6PA254	172	54	3.65	
		EVP6PA266	204	66	3.65	

## EVPB6PA2 - TWO-WAY 60 DEGREE POST FOR BELTLINE POWERED PANELS - ALUMINUM TRIM

- Connects two Beltline Powered panels of equal height in a 120 degree configuration.
- Provides slotted support for worksurfaces and hang-on storage components.
- Includes one 60 degree post, two slotted connectors with leveling glides, connecting hardware and trim kit.
- Connectors available without slots, as a special at no upcharge. Contact Customer Support.

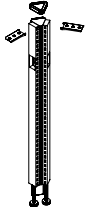
	DESCRIPTION	PRODUCT CODE	LIST PRICE	DIMENSIONS/INCHES		
				H	W	D
	Two-Way 60 Degree Post for Beltline Powered Panels - Aluminum Trim	EVPB6PA242	159	42	3.65	
		EVPB6PA254	172	54	3.65	
		EVPB6PA266	204	66	3.65	

## EVP6VPA2 - TWO-WAY 60 DEGREE VARIABLE - HEIGHT POST - ALUMINUM TRIM

- Connects two panels of differing height in a 120 degree configuration.
- Connector must reference taller panel.
- Provides slotted support for worksurfaces and hang-on storage components.
- Includes one 60 degree post, two slotted connectors with leveling glides, connecting hardware and trim kit.
- Connectors available without slots, as a special at no upcharge. Contact Customer Support.
- Please see page 92 on how to specify.

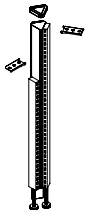
	DESCRIPTION	PRODUCT CODE	LIST PRICE	DIMENSIONS/INCHES		
				H	W	D
	Two-Way 60 Degree Variable - Height Post - Aluminum Trim	EVP6VPA242	138	42	3.65	
		EVP6VPA248	156	48	3.65	
		EVP6VPA254	172	54	3.65	
		EVP6VPA266	205	66	3.65	



**EVPB6VPA2 - TWO-WAY 60 DEGREE VARIABLE - HEIGHT POST FOR BELTLINE POWERED PANELS - ALUMINUM TRIM**

- Connects two Beltline Powered panels of differing height in a 120 degree configuration.
- Connector must reference taller panel.
- Provides slotted support for worksurfaces and hang-on storage components.
- Includes one 60 degree post, two slotted connectors with leveling glides, connecting hardware and trim kit.
- Connectors available without slots, as a special at no upcharge. Contact Customer Support.
- Please see page 92 on how to specify.

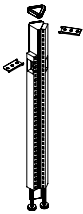
	DESCRIPTION	PRODUCT CODE	LIST PRICE	DIMENSIONS/INCHES		
				H	W	D
	Two-Way 60 Degree Variable - Height	EVPB6VPA242	160	42	3.65	
	Post for Beltline Powered Panels -	EVPB6VPA254	172	54	3.65	
	Aluminum Trim	EVPB6VPA266	205	66	3.65	

**EVP6P3 - THREE-WAY 60 DEGREE POST**

- Connects three panels of equal height in a 120 degree configuration.
- Provides slotted support for worksurfaces and hang-on storage components.
- Includes one 60 degree post, three slotted connectors with leveling glides and connecting hardware.
- Connectors available without slots, as a special at no upcharge. Contact Customer Support.

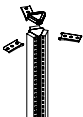
	DESCRIPTION	PRODUCT CODE	LIST PRICE	DIMENSIONS/INCHES		
				H	W	D
	Three-Way 60 Degree Post	EVP6P330	137	30	3.65	
		EVP6P342	184	42	3.65	
		EVP6P348	204	48	3.65	
		EVP6P354	224	54	3.65	
		EVP6P366	265	66	3.65	

**EVPB6P3 - THREE-WAY 60 DEGREE POST FOR BELTLINE POWERED PANELS**

- Connects three Beltline Powered panels of equal height in a 120 degree configuration.
- Provides slotted support for worksurfaces and hang-on storage components.
- Includes one 60 degree post, three slotted connectors with leveling glides and connecting hardware.
- Connectors available without slots, as a special at no upcharge. Contact Customer Support.

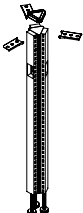
	DESCRIPTION	PRODUCT CODE	LIST PRICE	DIMENSIONS/INCHES		
				H	W	D
	Three-Way 60 Degree Post	EVPB6P342	184	42	3.65	
	for Beltline Powered Panels	EVPB6P354	224	54	3.65	
		EVPB6P366	265	66	3.65	

**EVP6VPA3 - THREE-WAY 60 DEGREE VARIABLE - HEIGHT POST - ALUMINUM TRIM**

- Connects three panels of differing height in a 120 degree configuration.
- Connector must reference taller panel.
- Provides slotted support for worksurfaces and hang-on storage components.
- Includes one 60 degree post, three slotted connectors with leveling glides, connecting hardware and trim kit.
- Connectors available without slots, as a special at no upcharge. Contact Customer Support.
- Please see page 92 on how to specify.

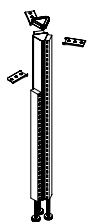
DESCRIPTION	PRODUCT CODE	LIST PRICE	DIMENSIONS/INCHES		
			H	W	D
 Three-Way 60 Degree Variable - Height Post - Aluminum Trim	EVP6VPA342	184	42	3.65	
	EVP6VPA348	204	48	3.65	
	EVP6VPA354	224	54	3.65	
	EVP6VPA366	265	66	3.65	

**EVPB6VPA3 - THREE-WAY 60 DEGREE VARIABLE - HEIGHT POST FOR BELTLINE POWERED PANELS - ALUMINUM TRIM**

- Connects three Beltline Powered panels of differing height in a 120 degree configuration.
- Connector must reference taller panel.
- Provides slotted support for worksurfaces and hang-on storage components.
- Includes one 60 degree post, three slotted connectors with leveling glides, connecting hardware and trim kit.
- Connectors available without slots, as a special at no upcharge. Contact Customer Support.
- Please see page 92 on how to specify.

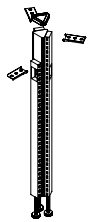
DESCRIPTION	PRODUCT CODE	LIST PRICE	DIMENSIONS/INCHES		
			H	W	D
 Three-Way for 60 Degree Variable - Height Post for Beltline Powered Panels - Aluminum Trim	EVPB6VPA342	201	42	3.65	
	EVPB6VPA354	224	54	3.65	
	EVPB6VPA366	265	66	3.65	

**EVP4P2 - TWO-WAY 45 DEGREE POST - ALUMINUM TRIM**

- Connects two panels of equal height in a 135 degree configuration.
- Provides slotted support for worksurfaces and hang-on storage components.
- Includes one 45 degree post, two slotted connectors with leveling glides, connecting hardware and trim kit.
- Connectors available without slots, as a special at no upcharge. Contact Customer Support.

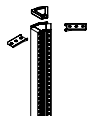
DESCRIPTION	PRODUCT CODE	LIST PRICE	DIMENSIONS/INCHES		
			H	W	D
 Two-Way 45 Degree Post Aluminum Trim	EVP4P230	111	30	3.65	
	EVP4P242	138	42	3.65	
	EVP4P248	149	48	3.65	
	EVP4P254	172	54	3.65	
	EVP4P266	204	66	3.65	



**EVP4VPA2 - TWO-WAY 45 DEGREE VARIABLE - HEIGHT POST - ALUMINUM TRIM**

- Connects two panels of differing height in a 135 degree configuration.
- Connector must reference taller panel.
- Provides slotted support for worksurfaces and hang-on storage components.
- Includes one 45 degree post, two slotted connectors with leveling glides, connecting hardware and trim kit.
- Connectors available without slots, as a special at no upcharge. Contact Customer Support.
- Please see page 92 on how to specify.

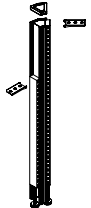
	DESCRIPTION	PRODUCT CODE	LIST PRICE	DIMENSIONS/INCHES		
				H	W	D
	Two-Way 45 Degree Variable - Height Post Aluminum Trim	EVP4VPA242	184	42	3.65	
		EVP4VPA248	204	48	3.65	
		EVP4VPA254	224	54	3.65	
		EVP4VPA266	265	66	3.65	

**EVPUERA - UPMOUNT END-OF-RUN POST KIT - ALUMINUM TRIM**

- Used at the end of Panel run to support Worksurfaces and Upmount Overhead Storage.
- Can attach to a Panel run to fixed wall.
- Adds 1" to the width of Light Panel run.
- 10% upcharge for Tungsten trim/paint.
- Aluminum trim must be specified when using premium color paints. Premium color paints are not available on PVC trim.

	DESCRIPTION	PRODUCT CODE	LIST PRICE	DIMENSIONS/INCHES		
				H	W	D
	Upmount End-of-Run Post Kit - Aluminum Trim.	EVPUERA66	101	66	2 7/8	

**EVPLUERA - UPMOUNT END-OF-RUN POST KIT FOR LIGHT PANELS (WALL MOUNTABLE) - ALUMINUM**

- Used at the end of Panel run to support Worksurfaces and Upmount Overhead Storage.
- Can attach to a Panel run to fixed wall.
- Adds 1" to the width of Light Panel run.
- Includes slotted Connector with leveling glide, connecting hardware, decorative sleeve and trim kit.

	DESCRIPTION	PRODUCT CODE	LIST PRICE	DIMENSIONS/INCHES		
				H	W	D
	Upmount End-of-Run Post Kit - for Light Panels - Wall Mountable - Aluminum	EVPLUERA66	101	66	2 7/8	

**EVPUETA - UPMOUNT END-OF-RUN TRIM - ALUMINUM**

- Replaces existing 66”h End-of-Run Trim Only
- Comes with one Upmount Extension Trim EVPUET12 and one Upmount End-of-Run Trim.
- Must be used in conjunction with slotted connectors.

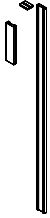
	DESCRIPTION	PRODUCT CODE	LIST PRICE	DIMENSIONS/INCHES		
				H	W	D
	Upmount End-of-Run Trim - Aluminum	EVPUETA66	70		2 7/8	

**EVPLUETA - UPMOUNT END-OF-RUN TRIM FOR LIGHT PANELS - ALUMINUM**

- Includes one Upmount Extension Trim EVPUETA12 and one Upmount End-of-Run Trim.
- Must be used in conjunction with Slotted Connector.

	DESCRIPTION	PRODUCT CODE	LIST PRICE	DIMENSIONS/INCHES		
				H	W	D
	Upmount End-of-Run Trim for Light Panels - Aluminum	EVPLUETA66	70	63	2 7/8	

**EVAFMB01 - FLOOR MOUNT PLATE**

- Attaches to floor.
- Secures panel to floor.
- Attachment screws are not included.
- Care should be taken to use correct fasteners for type of floor.
- Available in chrome finish only.

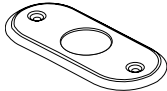
	DESCRIPTION	PRODUCT CODE	LIST PRICE	DIMENSIONS/INCHES		
				H	W	D
	Floor Mount Plate	EVAFMB01	60	0.25	5	2.5



**EVPIECS - INLINE EXTENSION CONNECTOR - SLOTTED**

- Connects two extension modules in a straight run.
- Includes one slotted inline extension connector and connecting hardware.
- Provides slotted support for worksurfaces and hang-on storage, up to 66”H.

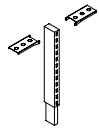
	DESCRIPTION	PRODUCT CODE	LIST PRICE	DIMENSIONS/INCHES		
				H	W	D
	Inline Extension Connector - Slotted	EVPIECS06	31	6	2 7/8	
		EVPIECS12	31	12	2 7/8	
		EVPIECS18	37	18	2 7/8	
		EVPIECS24	37	24	2 7/8	

**EVPEERSA - END-OF-RUN EXTENSION CONNECTOR - SLOTTED - ALUMINUM TRIM**

- Connects at the end of a run of extension modules, and can be used to attach a panel to a fixed wall.
- Adds 1” to the width of panel run.
- Includes one slotted inline extension connector, connecting hardware and trim kit.
- Provides slotted support for worksurfaces and hang-on storage, up to 66”H.

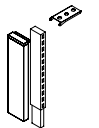
	DESCRIPTION	PRODUCT CODE	LIST PRICE	DIMENSIONS/INCHES		
				H	W	D
	End-of-Run Extension Connector - Slotted - Aluminum Trim	EVPEERSA06	33	6	2 7/8	
		EVPEERSA12	33	12	2 7/8	
		EVPEERSA18	41	18	2 7/8	
		EVPEERSA24	41	24	2 7/8	

**EVPCEPSA2 - TWO-WAY POST EXTENSION - SLOTTED - ALUMINUM TRIM**

- Connects two extension modules in a 90 degree configuration.
- Post and connecting hardware adds 3.25” to the panel run.
- Includes one post, two slotted inline extension connectors, connecting hardware and trim kit.
- Provides slotted support for worksurfaces and hang-on storage, up to 66”H.

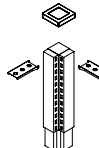
	DESCRIPTION	PRODUCT CODE	LIST PRICE	DIMENSIONS/INCHES		
				H	W	D
	Two-Way Post Extension - Slotted Aluminum Trim	EVPCEPSA206	61	6	2 7/8	
		EVPCEPSA212	61	12	2 7/8	
		EVPCEPSA218	95	18	2 7/8	
		EVPCEPSA224	95	24	2 7/8	

**EVPCEPSA3 - THREE-WAY POST EXTENSION - SLOTTED - ALUMINUM TRIM**

- Connects three extension modules in a “T” configuration.
- Post and connecting hardware adds 3.25” to the panel run.
- Includes one post, three slotted inline extension connectors, connecting hardware and trim kit.
- Provides slotted support for worksurfaces and hang-on storage, up to 66”H.

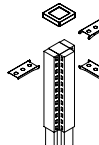
	DESCRIPTION	PRODUCT CODE	LIST PRICE	DIMENSIONS/INCHES		
				H	W	D
	Three-Way Post Extension - Slotted Aluminum Trim	EVPCEPSA306	72	6	2 7/8	
		EVPCEPSA312	72	12	2 7/8	
		EVPCEPSA318	113	18	2 7/8	
		EVPCEPSA324	113	24	2 7/8	

**EVPCEPS4 - FOUR-WAY POST EXTENSION - SLOTTED**

- Connects four extension modules in a “+” configuration.
- Post and connecting hardware adds 3.25” to the panel run.
- Includes one post, four slotted inline extension connectors, connecting hardware and trim kit.
- Provides slotted support for worksurfaces and hang-on storage, up to 66”H.

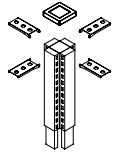
	DESCRIPTION	PRODUCT CODE	LIST PRICE	DIMENSIONS/INCHES		
				H	W	D
	Four-Way Post Extension - Slotted	EVPCEPS406	84	6	2 7/8	
		EVPCEPS412	84	12	2 7/8	
		EVPCEPS418	125	18	2 7/8	
		EVPCEPS424	125	24	2 7/8	

**EVPCEPSA1 - ONE-WAY POST EXTENSION - SLOTTED - ALUMINUM TRIM**

- Connects at the end of a run of extension modules in place of an EVPEERSA – End-of-Run Extension Connector.
- Should not be used to attach a panel to a fixed wall.
- Post and connecting hardware adds 3.25” to the panel run.
- Includes one post, one slotted inline extension connector, connecting hardware and trim kit.
- Provides slotted support for worksurfaces and hang-on storage, up to 66”H.

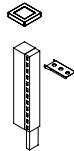
	DESCRIPTION	PRODUCT CODE	LIST PRICE	DIMENSIONS/INCHES		
				H	W	D
	One-Way Post Extension - Slotted Aluminum Trim	EVPCEPSA106	59	6	2 7/8	
		EVPCEPSA112	59	12	2 7/8	
		EVPCEPSA118	74	18	2 7/8	
		EVPCEPSA124	74	24	2 7/8	

**EVPCEIPSA2 – INLINE TWO-WAY POST EXTENSION - SLOTTED - ALUMINUM TRIM**

- Connects two extension modules in a straight line in place of EVPIECS – In-Line Extension Connector.
- Post and connecting hardware adds 3.25” to the panel run.
- Includes one post, two slotted inline extension connectors, connecting hardware and trim kit.
- Provides slotted support for worksurfaces and hang-on storage, up to 66”H.

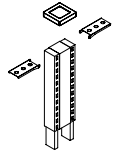
	DESCRIPTION	PRODUCT CODE	LIST PRICE	DIMENSIONS/INCHES		
				H	W	D
	Inline Two-Way Post Extension - Slotted Aluminum Trim	EVPCEIPSA206	64	6	2 7/8	
		EVPCEIPSA212	64	12	2 7/8	
		EVPCEIPSA218	104	18	2 7/8	
		EVPCEIPSA224	104	24	2 7/8	



**EVP6CEPSA2 - TWO-WAY 60 DEGREE POST EXTENSION - SLOTTED - ALUMINUM TRIM**

- Connects two extension modules in a 120 degree configuration.
- Includes one post, two slotted inline extension connectors, connecting hardware and trim kit.
- Provides slotted support for worksurfaces and hang-on storage, up to 66"H.

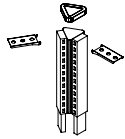

DESCRIPTION	PRODUCT CODE	LIST PRICE	DIMENSIONS/INCHES		
			H	W	D
Two-Way 60 Degree Post Extension - Slotted - Aluminum Trim	EVP6CEPSA206	61	6	3.65	
	EVP6CEPSA212	61	12	3.65	
	EVP6CEPSA218	94	18	3.65	
	EVP6CEPSA224	94	24	3.65	

**EVP6CEPS3 - THREE-WAY 60 DEGREE POST EXTENSION - SLOTTED**

- Connects three extension modules in a 120 degree configuration.
- Includes one post, three slotted inline extension connectors and connecting hardware.
- Provides slotted support for worksurfaces and hang-on storage, up to 66"H.

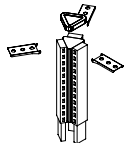

DESCRIPTION	PRODUCT CODE	LIST PRICE	DIMENSIONS/INCHES		
			H	W	D
Three-Way 60 Degree Post Extension - Slotted	EVP6CEPS306	71	6	3.65	
	EVP6CEPS312	71	12	3.65	
	EVP6CEPS318	113	18	3.65	
	EVP6CEPS324	113	24	3.65	

**EVP6CEPSA1 - ONE-WAY 60 DEGREE POST EXTENSION - SLOTTED - ALUMINUM TRIM**

- Connects at the end of a run of extension modules in a 120 degree configuration.
- Should not be used to attach a panel to a fixed wall.
- Includes one post, one slotted inline extension connector, connecting hardware and trim kit.
- Provides slotted support for worksurfaces and hang-on storage, up to 66"H.

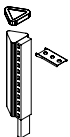

DESCRIPTION	PRODUCT CODE	LIST PRICE	DIMENSIONS/INCHES		
			H	W	D
One-Way 60 Degree Post Extension - Slotted - Aluminum Trim	EVP6CEPSA106	59	6	3.65	
	EVP6CEPSA112	59	12	3.65	
	EVP6CEPSA118	73	18	3.65	
	EVP6CEPSA124	73	24	3.65	



**EVP4CEPS2 - TWO-WAY 45 DEGREE POST EXTENSION - SLOTTED - ALUMINUM TRIM**

- Connects two extension modules in a 135 degree configuration.
- Includes one post, two slotted inline extension connectors, connecting hardware and trim kit.
- Provides slotted support for worksurfaces and hang-on storage, up to 66"H.

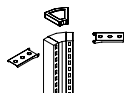
	DESCRIPTION	PRODUCT CODE	LIST PRICE	DIMENSIONS/INCHES		
				H	W	D
	Two-Way 45 Degree Post Extension - Slotted - Aluminum Trim	EVP4CEPS206	61	6	3.65	
		EVP4CEPS212	61	12	3.65	
		EVP4CEPS218	94	18	3.65	
		EVP4CEPS224	94	24	3.65	

**EVP4CEPSA1 - ONE-WAY 45 DEGREE POST EXTENSION - SLOTTED - ALUMINUM TRIM**

- Connects at the end of a run of extension modules in a 135 degree configuration.
- Should not be used to attach a panel to a fixed wall.
- Includes one post, one slotted inline extension connector, connecting hardware and trim kit.
- Provides slotted support for worksurfaces and hang-on storage, up to 66"H.

	DESCRIPTION	PRODUCT CODE	LIST PRICE	DIMENSIONS/INCHES		
				H	W	D
	One-Way 45 Degree Post Extension - Slotted - Aluminum Trim	EVP4CEPSA106	59	6	3.65	
		EVP4CEPSA112	59	12	3.65	
		EVP4CEPSA118	73	18	3.65	
		EVP4CEPSA124	73	24	3.65	

**EVPUETA - UPMOUNT EXTENSION TRIM - ALUMINUM**

- Finishes the exposed connector above a shorter panel.
- Slotted connector not included.

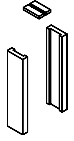
	DESCRIPTION	PRODUCT CODE	LIST PRICE	DIMENSIONS/INCHES		
				H	W	D
	Upmount Extension Trim - Aluminum	EVPUETA12	31	12	2.78	



**EVPERTA - END-OF-RUN TRIM - ALUMINUM**

- Finishes the exposed Connector at the end of a run.
- Slotted Connector not included.

	DESCRIPTION	PRODUCT CODE	LIST PRICE	DIMENSIONS/INCHES		
				H	W	D
	End-of-Run Trim - Aluminum	EVPERTA30	34	30	2 7/8	
		EVPERTA42	47	42	2 7/8	
		EVPERTA48	50	48	2 7/8	
		EVPERTA54	53	54	2 7/8	
		EVPERTA66	60	66	2 7/8	
		EVPERTA78	66	78	2 7/8	
		EVPERTA90	68	90	2 7/8	

**EVPLERTA - END-OF-RUN TRIM FOR LIGHT PANELS - ALUMINUM**

- Finishes the exposed Connector at the end of a run of the Light Panels.
- Slotted Connector not included.

	DESCRIPTION	PRODUCT CODE	LIST PRICE	DIMENSIONS/INCHES		
				H	W	D
	End-of-Run Trim for Light Panels - Aluminum	EVPLERTA30	35	26 1/4	2 7/8	
		EVPLERTA42	41	38 1/4	2 7/8	
		EVPLERTA48	47	44 1/4	2 7/8	
		EVPLERTA54	55	50 1/4	2 7/8	
		EVPLERTA66	60	62 1/4	2 7/8	
		EVPLERTA72	62	68 1/4	2 7/8	
		EVPLERTA78	64	74 1/4	2 7/8	
		EVPLERTA84	67	80 1/4	2 7/8	
		EVPLERTA90	70	86 1/4	2 7/8	

**EVPTVA - PANEL TRIM - VARIABLE HEIGHT - ALUMINUM**

- Attaches to the exposed end of the taller panel when 2 panels of different height meet in straight run.
- Slotted Connector not included.

	DESCRIPTION	PRODUCT CODE	LIST PRICE	DIMENSIONS/INCHES		
				H	W	D
	Panel Trim - Variable Height - Aluminum	EVPTVA06	12	6	2 7/8	
		EVPTVA12	18	12	2 7/8	
		EVPTVA18	23	18	2 7/8	
		EVPTVA24	30	24	2 7/8	
		EVPTVA30	35	30	2 7/8	
		EVPTVA36	41	36	2 7/8	

**EVPTEA - PANEL EXTENSION TRIM - ALUMINUM**

- Attaches to bottom of exposed end of panel to provide extension for End-of-Run post trim kit when using panel extensions.
- Does not include slotted connector nor connecting hardware.



DESCRIPTION	PRODUCT CODE	LIST PRICE	DIMENSIONS/INCHES		
			H	W	D
Panel Extension Trim - Aluminum	EVPTEA12	16	12	2 7/8	
	EVPTEA18	23	18	2 7/8	
	EVPTEA24	29	24	2 7/8	

**EVPVTF A - FLAT TRIM - ALUMINUM**

- To be used with 30"H posts as a replacement trim.
- For "U" trim configuration use three flat trim according to height specifications.
- For "L" trim configuration use two flat trim according to height configurations.



DESCRIPTION	PRODUCT CODE	LIST PRICE	DIMENSIONS/INCHES		
			H	W	D
Flat Trim - Aluminum	EVPVTF A30	9	29 1/8	2 7/8	
	EVPVTF A36	10	34 1/8	2 7/8	
	EVPVTF A42	12	41 1/8	2 7/8	
	EVPVTF A48	16	47 1/8	2 7/8	
	EVPVTF A54	16	53 1/8	2 7/8	
	EVPVTF A66	18	65 1/8	2 7/8	
	EVPVTF A78	19	77 1/8	2 7/8	
	EVPVTF A84	21	83 1/8	2 7/8	
	EVPVTF A90	20	89 1/8	2 7/8	
	EVPVTF A96	22	95 1/8	2 7/8	

**EVPVTF EA - FLAT EXTENSION TRIM - ALUMINUM**

- Finishes exposed faces of One-Way, Two-Way, Three-Way and Inline Panels.
- For reconfiguration and replacement use only.
- For "U" trim configuration use three flat trim according to height specification.
- For "L" trim configuration use two flat trim according to height specification.
- Aluminum Trim must be specified when using premium color paints.



DESCRIPTION	PRODUCT CODE	LIST PRICE	DIMENSIONS/INCHES		
			H	W	D
Flat Extension Trim - Aluminum	EVPVTF EA12	8	12 3/8	2 7/8	
	EVPVTF EA18	10	18 3/8	2 7/8	
	EVPVTF EA24	10	24 3/8	2 7/8	
	EVPVTF EA30	12	30 3/8	2 7/8	
	EVPVTF EA36	16	36 3/8	2 7/8	
	EVPVTF EA42	17	42 3/8	2 7/8	
	EVPVTF EA48	18	48 3/8	2 7/8	
	EVPVTF EA54	19	54 3/8	2 7/8	
	EVPVTF EA66	21	66 3/8	2 7/8	
	EVPVTF EA78	22	78 3/8	2 7/8	
	EVPVTF EA84	28	84 3/8	2 7/8	
	EVPVTF EA90	29	90 3/8	2 7/8	
	EVPVTF EA96	30	96 3/8	2 7/8	



**EVPLVTFA - FLAT TRIM FOR LIGHT PANELS - ALUMINUM**

- Finishes exposed faces of One-Way, Two-Way, Three-Way and Inline Panels.
- For reconfiguration and replacement use only.
- For "U" trim configuration use three flat trim according to height specification.
- For "L" trim configuration use two flat trim according to height specification.
- Aluminum Trim must be specified when using premium color paints.

DESCRIPTION	PRODUCT CODE	LIST PRICE	DIMENSIONS/INCHES		
			H	W	D
 Flat Trim for Light Panels - Aluminum	EVPLVTFA30	9	26 1/4	2 7/8	
	EVPLVTFA42	12	38 1/4	2 7/8	
	EVPLVTFA48	16	44 1/4	2 7/8	
	EVPLVTFA54	16	50 1/4	2 7/8	
	EVPLVTFA66	18	62 1/4	2 7/8	
	EVPLVTFA72	18	68 1/4	2 7/8	
	EVPLVTFA78	19	74 1/4	2 7/8	
	EVPLVTFA84	19	80 1/4	2 7/8	
	EVPLVTFA90	20	86 1/4	2 7/8	

**EVPTTA - PANEL TOP TRIM - ALUMINUM - FIELD INSTALLED**

- This trim can span an Inline Connector, but not a Post Connector.

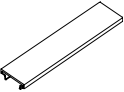
DESCRIPTION	PRODUCT CODE	LIST PRICE	DIMENSIONS/INCHES		
			H	W	D
 Panel Top Trim - Aluminum	EVPTTA18F	8	18	2 7/8	
	EVPTTA24F	12	24	2 7/8	
	EVPTTA30F	17	30	2 7/8	
	EVPTTA36F	19	36	2 7/8	
	EVPTTA42F	23	42	2 7/8	
	EVPTTA48F	29	48	2 7/8	
	EVPTTA54F	33	54	2 7/8	
	EVPTTA60F	37	60	2 7/8	
	EVPTTA66F	41	66	2 7/8	
	EVPTTA72F	46	72	2 7/8	
	EVPTTA78F	50	78	2 7/8	
	EVPTTA84F	55	84	2 7/8	
	EVPTTA90F	59	90	2 7/8	
	EVPTTA96F	64	96	2 7/8	

**EVPTNTA - PANEL TOP SINGLE NOTCHED TRIM - ALUMINUM - FIELD INSTALLED**

- Used when connecting a lower Panel to a higher Panel
- This trim can span an Inline Connector, but not a Post Connector.

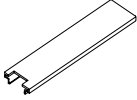
DESCRIPTION	PRODUCT CODE	LIST PRICE	DIMENSIONS/INCHES		
			H	W	D
 Panel Top Single Notched Trim - Aluminum	EVPTNTA18F	10	18	2 7/8	
	EVPTNTA24F	14	24	2 7/8	
	EVPTNTA30F	17	30	2 7/8	
	EVPTNTA36F	19	36	2 7/8	
	EVPTNTA42F	22	42	2 7/8	
	EVPTNTA48F	30	48	2 7/8	
	EVPTNTA54F	34	54	2 7/8	
	EVPTNTA60F	39	60	2 7/8	
	EVPTNTA66F	42	66	2 7/8	
	EVPTNTA72F	46	72	2 7/8	
	EVPTNTA78F	49	78	2 7/8	
	EVPTNTA84F	53	84	2 7/8	
	EVPTNTA90F	56	90	2 7/8	
	EVPTNTA96F	59	96	2 7/8	

**EVPTDNTA - PANEL TOP DOUBLE NOTCHED TRIM - ALUMINUM - FIELD INSTALLED**

- Used when connecting a lower Panel to a higher Panel
- This trim can span an Inline Connector, but not a Post Connector.

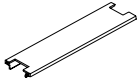
DESCRIPTION	PRODUCT CODE	LIST PRICE	DIMENSIONS/INCHES		
			H	W	D
 Panel Top Double Notched Trim - Aluminum	EVPTDNTA18F	12	18	2 7/8	
	EVPTDNTA24F	17	24	2 7/8	
	EVPTDNTA30F	19	30	2 7/8	
	EVPTDNTA36F	21	36	2 7/8	
	EVPTDNTA42F	23	42	2 7/8	
	EVPTDNTA48F	31	48	2 7/8	
	EVPTDNTA54F	35	54	2 7/8	
	EVPTDNTA60F	41	60	2 7/8	
	EVPTDNTA66F	45	66	2 7/8	
	EVPTDNTA72F	48	72	2 7/8	
	EVPTDNTA78F	52	78	2 7/8	
	EVPTDNTA84F	55	84	2 7/8	
	EVPTDNTA90F	58	90	2 7/8	
	EVPTDNTA96F	61	96	2 7/8	

**EVSC12 - SLOT COVER**

- Covers the slots of a slotted connector between modules as well as corner post situation.
- Available in all standard colors (Black, Charcoal Silver, Taupe, Tungsten, White and Nevada)
- Sold per foot. The desired quantity of the slot covers is the required length in feet.
- An easy way to calculate the required length is to sum the length of all inline connectors used in a project (including the posts) and multiply by 2.
- Should be field cut to required length.

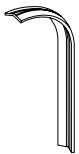
DESCRIPTION	PRODUCT CODE	LIST PRICE	DIMENSIONS/INCHES		
			H	W	D
 Slot Cover	EVSC12	3			



electrical

**STEP-BY-STEP SPECIFICATION – 8-WIRE ELECTRICAL SYSTEM**

**Step 1 Determine the location of the source power entering the Panel Run.**

1. At the base of the Panel.
  - (a) Use EVE8FR1 Reversible Floor Power Entry (default to EVE8FR1).
  - (b) Select the Panel to which the Floor Power Entry will be attached. This Panel requires an EVEPD Power Distribution Housing.
  - (c) Select the side of the Panel and the receptacle outlet to which the Floor Power Entry is to be attached.
2. From the ceiling.
  - (a) Use EVE8EC1 Ceiling Power Entry.
  - (b) Select the post through which to feed the Ceiling Power Entry.
  - (c) One Panel adjacent to the selected post requires an EVEPD Power Distribution Housing.
  - (d) Attach Ceiling Power entry to the nearest end of the Power Distribution Housing.

**Step 2 Determine which Panels are to be powered.**

1. Use EVE8PD Power Distribution Housing that corresponds with the width of the Panel.

**Step 3 Connect power to the powered Panels.**

1. Use EVE8CP16 Jumper Cable between two adjacent powered Panels, separated by an Inline Connector.
2. Use EVE8CP20 Jumper Cable between two adjacent powered Panels separated by a post.
3. Use EVE8CP Pass-Through Cables to connect powered Panels that are separated by one or more non-powered Panels (maximum distance between the powered Panels is 16 feet).
  - (a) The length of the Pass-Through Cable is calculated by adding together the widths of the non-powered Panels (that separate the two powered Panels) and applying an additional 16" to the total. (EVE8PD Power Distribution Housing is positioned 8" in from the ends of the powered Panel.) (b) An additional 3" must be added to the Pass-Through Cable for each post that the cable passes through.
4. From the price list, select the EVE8CP Pass-Through Cable that matches the calculated length. If the length is between listed sizes, use the next size up.

**Step 4 Determine the location and circuitry of the receptacles.**

1. Each powered Panel has four (4) potential locations for EVE8RD Duplex Receptacles – 2 per side. (Exception: 24" wide Panel has only two potential locations – 1 per side, 18" wide Panel has no locations for receptacles.)
2. At each receptacle location there is a choice of four circuit options. Select a circuit option for each location. Circuits one & two are utility circuits; circuits A & B are dedicated circuits.

**BELTLINE TIPS:**

**DO** - use a 17" long Mesh Beltline Jumper when making 90 degree turns in the Beltline raceways only.

**DO NOT** - use a 20" long Metal Flex Jumper when attempting to make 90 degree turns in the Beltline Raceways. The end connector is too long to make the turn.

**DO** - use a 20" long Metal Flex Jumper when traveling through a Beltline Post, in a straight line only.

**DO NOT** - use a 17" long Mesh Beltline Jumper Traveling through a Beltline Post, in a straight line only. The Jumper is too short to make the connection.

**EVOLVE'S MODIFIED 8-WIRE ELECTRICAL SYSTEM**

Evolve has modified its 8-Wire Electrical System to stay abreast of changing industry standards.

Evolve's electrical system allows for the integration of the commonly required "2+2" configuration (2 utility circuits, 2 dedicated circuits) found in the source power of most of today's North American buildings.

**This system is rated for connection to:**

1. A grounded 120/240V, single phase, 20 A, 60Hz
2. A 120/208V, 3 phase, 20 A, 60Hz branch circuit

**EQUIPMENT AMPERAGE**

Calculator .....	0.25
Electric Eraser .....	0.50
Pencil Sharpener .....	1.00
Radio .....	0.05
Paper Shredder.....	4.40 - 13.00
Electric Typewriter .....	1.20
Personal Computer.....	2.00 - 4.00
Video Display Terminal .....	0.08
Draft / Letter Quality Printer.....	1.20 - 3.00

**Data/Comm**

Evolve's duplex receptacle openings will now conform to the ANSI/TIA/EIA Furniture Opening Standard of 1.38 +/- .035 x 2.71 +/- .04. There will no longer be the need to use adapter plates to reduce the size of Evolve's raceway opening, or to use Evolve dedicated data plates for data/comm terminations.

**Transition**

A transition cable is available to connect the previous electrical system prior to April 1, 2005 to the current system when adding Panels to an existing installation. Also, new raceway covers with the smaller openings can be provided and applied to existing Panels when retrofitted with new electrics.

Fan.....	1.00
Heater.....	8.50 - 12.50
Coffee Pot.....	15.00
Task Light .....	1.00
Slide Projector.....	2.00 - 6.00
Laser Printer .....	5.00 - 8.00
Processor / Disk Unit .....	1.00 - 10.00
Desk Top Plotter.....	1.50

Some equipment, such as large copiers, printers, plotters, heaters and coffee makers may occupy most of the circuit capacity. It is recommended that such devices be supplied with the power directly from the wall or building receptacle.



WIRING SCHEMATIC

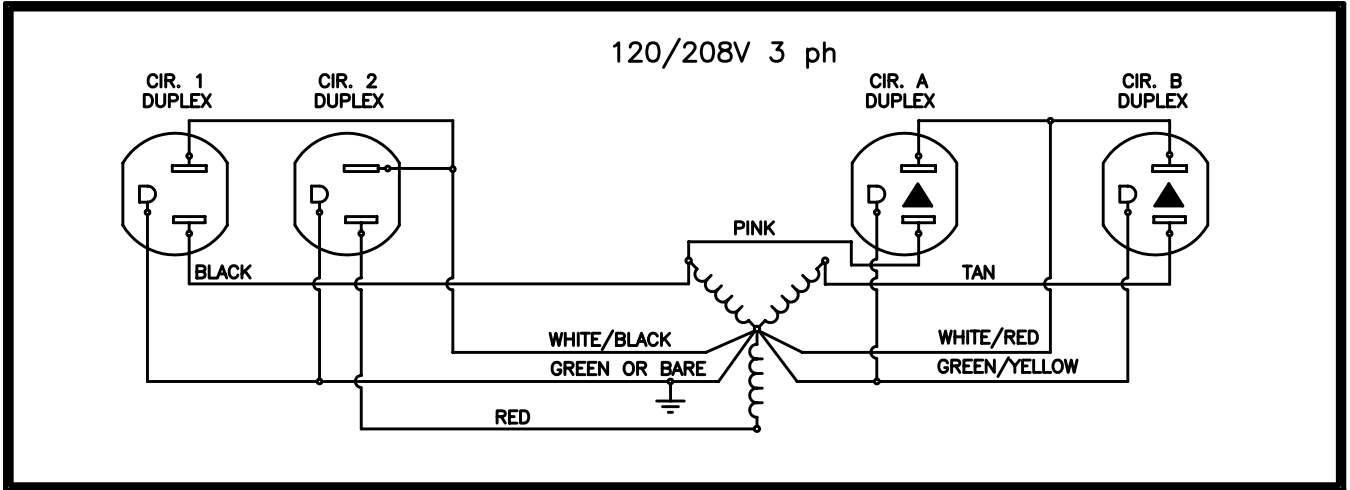
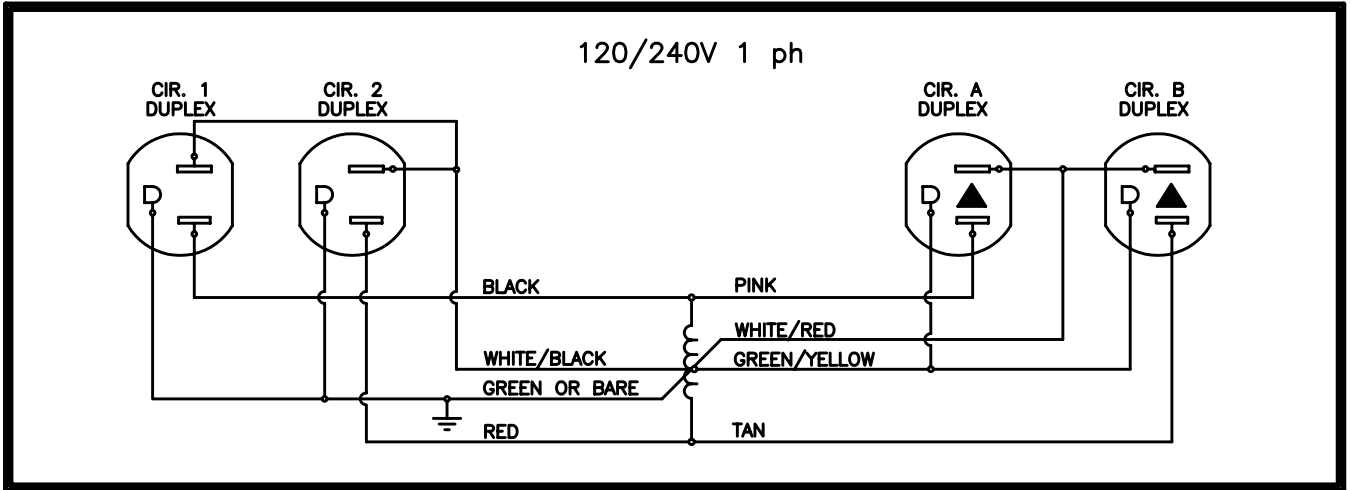

**DEFINING “2 + 2” WIRING CONFIGURATIONS**

**2 + 2 Configuration (8 wire, 4 circuit)**

Two Utility Circuits [Evolve’s #1 & #2 circuits] share one neutral wire and one ground wire.  
(2 hot [circuit] wires + 1 neutral wire\*\*\* + 1 green ground wire\* = 4 wires)

Two Dedicated Circuits [Evolve’s “A” & “B” circuits] share one neutral wire and one ground wire.  
(2 hot [circuit] wires + 1 neutral wire \*\*\* + 1 green/yellow ground wire\*\* = 4 wires)

**NOTE:**

It is the ground wire that makes the difference between “Utility” and “Dedicated” circuits. Refer to Wiring Schematics found in the Price List.

\* A Green ground wire is a “system” ground. This means it could be grounded to any piece of metal, including the Panel.

\*\* A Green/Yellow ground wire is isolated, within the wiring conduit, all the way back to the box at the source (building ground).

\*\*\* All Neutral Wires are 10 gauge rather than 12 gauge meaning they are larger than normal, allowing greater protection against “noise” or interference on the circuit.



This page provides an exploded view of a sample configuration highlighting each **Electrical** component required when specifying this configuration.

## Components

- A.** EVE8PD42 Power Distribution Housing  
Note: 8 wire, 4 circuits (3rd/4th circuits dedicated) labeled A or B.
- B.** EVE8CP16 Jumper Cable  
Note: EVE8CP16 connects two powered panels positioned side by side, separated by an Inline Connector  
EVE8CP20 connects two powered panels separated by a post.
- C.** EVE8RD Duplex Receptacle
- D.** EVE8CP Pass-Through Cable  
Note: Pass-Through Extension Cable (EVE8CPF154) available – extends power capability beyond 208".

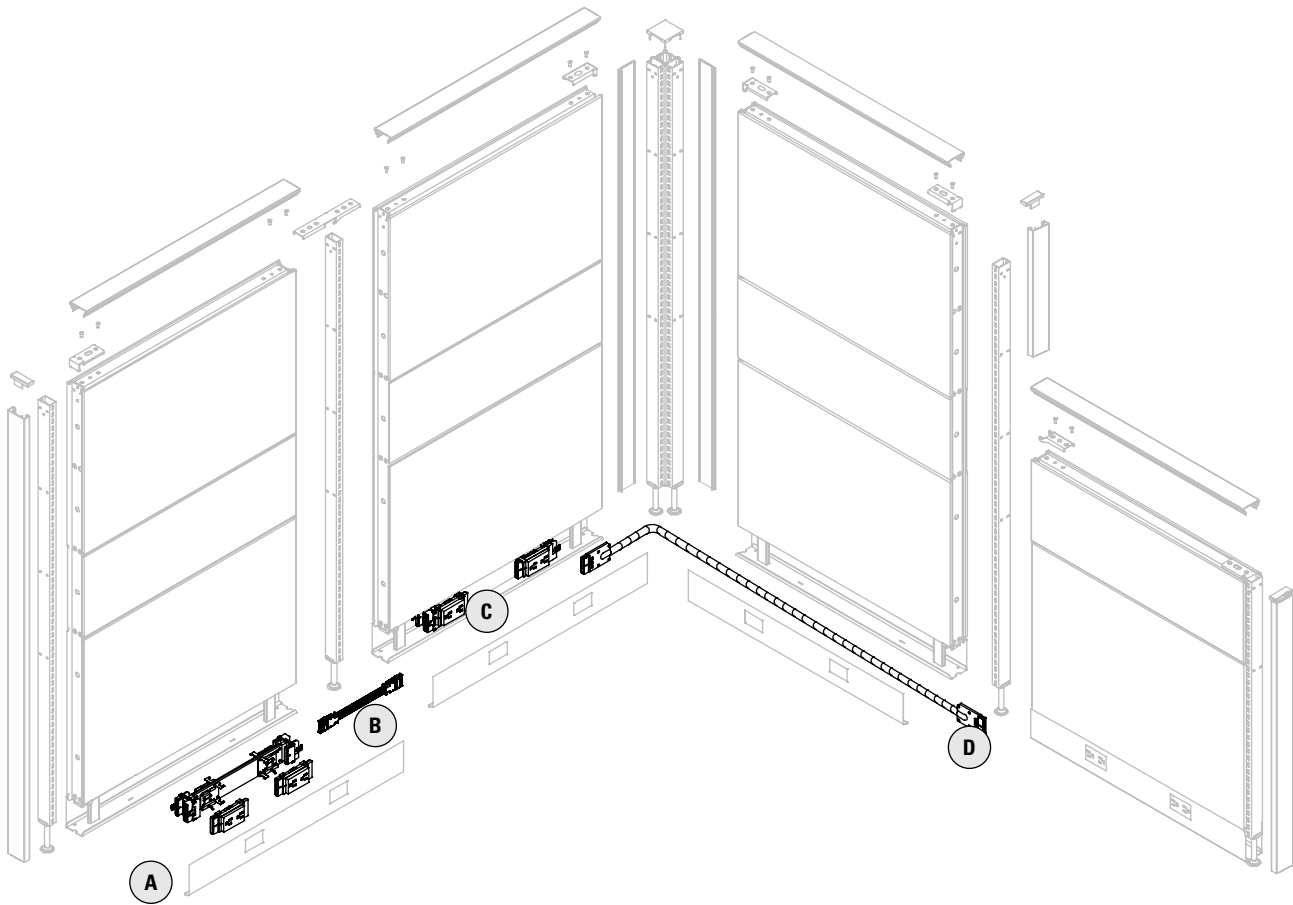

This page provides an exploded view of a sample configuration highlighting each **Beltline Power Panel** component required when specifying this configuration.

- |   |  |
|---|--|
| <p><b>A.</b> EVE8PD36 Power Distribution Housing<br/>Note: 8 wire, 4 circuits (3rd/4th circuits dedicated) labeled A or B.</p> <p><b>B.</b> EVE8CP17 Jumper Cable<br/>Note: EVE8CP16 connects two powered panels positioned side by side, separated by an Inline Connector</p> <p><b>C.</b> EVE8RD Duplex Receptacle</p> <p><b>D.</b> EVE8CP Pass-Through Cable<br/>Note: Pass-Through Extension Cable (EVE8CPF154) available – extends power capability beyond 208".</p> | <p><b>E.</b> EVE8CP20 Jumper Cable<br/>Note: EVE8CP20 connects two powered panels separated by a post, in a straight line.</p> <p><b>F.</b> EVE8CP917 Jumper Cable<br/>Note: EVE8CP20 connects two powered panels separated by a post, for turns through post.</p> <p><b>G.</b> EVE8CPCP Base to Belt Pass Through Kit<br/>Note: For use in Chimney Panels only.</p> |
|---|--|

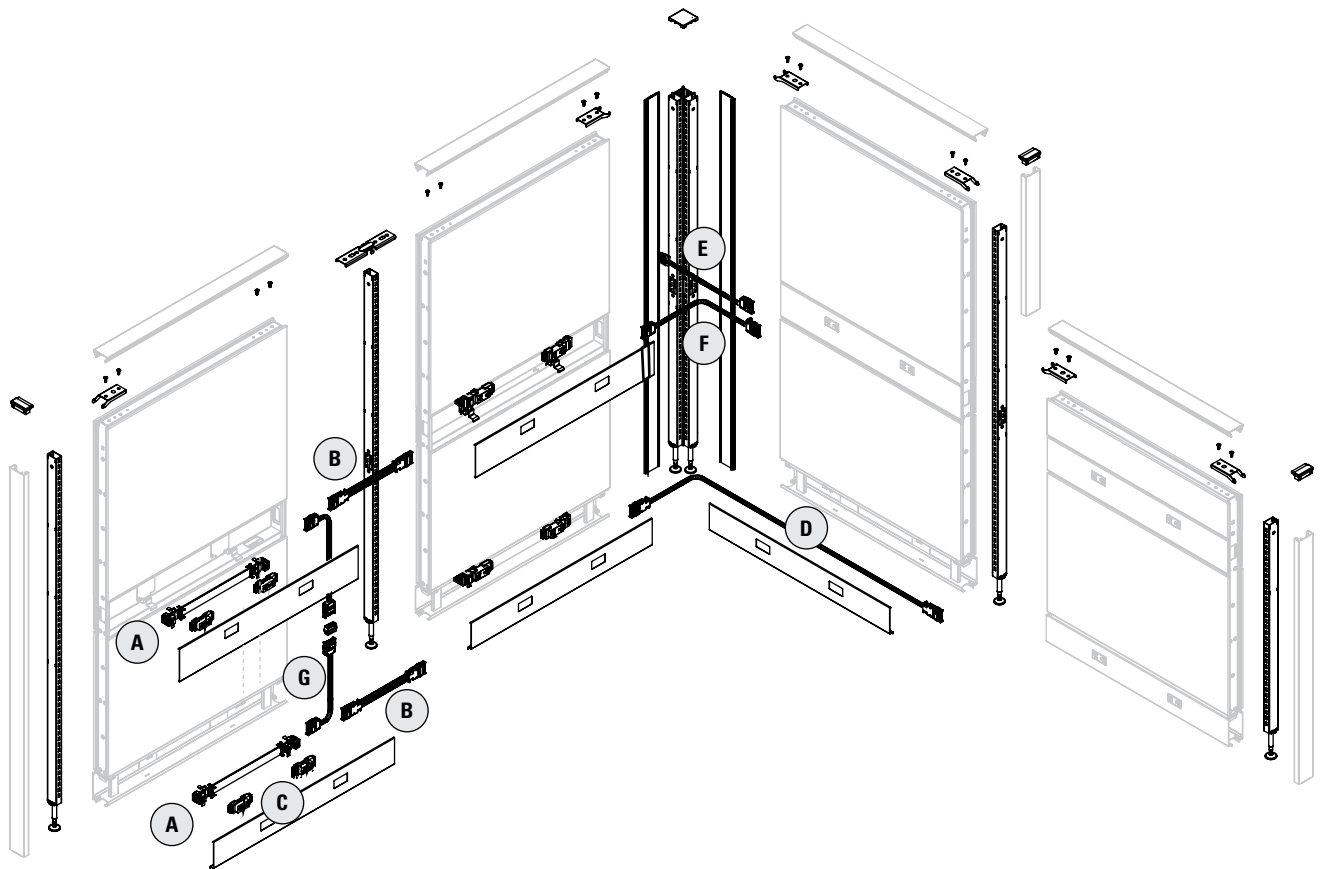

# ELECTRICAL

## EVE8PD - POWER DISTRIBUTION HOUSING

- Power housing is specified per panel size (e.g. EVE8PD36 is for use in a 36" panel).
- 8 wire, 4 circuits (2+2 configuration).
- Provides two duplex receptacles per panel side on all panel widths except the 24" wide panel.
- 24" wide panel allows for only one (1) duplex receptacle per panel side.
- Each power distribution housing supports 15-20 amps.

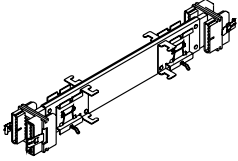
	DESCRIPTION	PRODUCT CODE	LIST PRICE	DIMENSIONS/INCHES		
				H	L	D
	Power Distribution Housing	EVE8PD24	109		6 1/4	
		EVE8PD30	147		11 1/2	
		EVE8PD36	155		17 1/2	
		EVE8PD42	158		23 1/2	
		EVE8PD48	170		29 1/2	
		EVE8PD54	171		39 1/4	
		EVE8PD60	172		41 1/2	

## EVE8CP - JUMPER CABLE

- The EVE8CP16 electrically connects two powered panels positioned side by side, separated by an Inline connector
- The EVE8CP20 electrically connects two powered panels separated by a post.

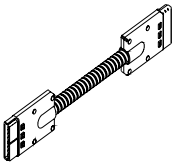
	DESCRIPTION	PRODUCT CODE	LIST PRICE	DIMENSIONS/INCHES		
				H	L	D
	Jumper Cable	EVE8CP16	90		16	
		EVE8CP20	105		20	

## EVE8CPCP - CHIMNEY PANEL JUMPER CABLE KIT

- Contains two (2) 17" flexible harnesses and one (1) "I" connector.
- Used to connect electric from the base to the beltline raceway in Beltline Powered Chimney panel.
- Must use in conjunction with base power distribution harness and beltline power distribution harness (sold separately)

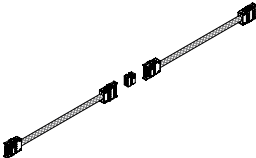
	DESCRIPTION	PRODUCT CODE	LIST PRICE	DIMENSIONS/INCHES		
				H	L	D
	Chimney Panel Jumper Cable Kit	EVE8CPCP	229			

## EVE8CP17 - FLEXIBLE MESH JUMPER CABLE

- One (1) 17.5" flexible harness
- Used to connect two power distribution housings at the beltline level at 90 degrees.

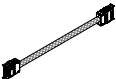
	DESCRIPTION	PRODUCT CODE	LIST PRICE	DIMENSIONS/INCHES		
				H	L	D
	Flexible Mesh Jumper Cable	EVE8CP17	83			



# ELECTRICAL

## EVE8CP - PASS-THROUGH CABLE

- Flexible metal conduit is used to distribute electrical power through non-powered panels.
- To calculate the length of a Pass-Through Cable, add the widths of the non-powered panels separating the powered panels (panels with distribution housing attached). To this, add 16" (distance from the edge of the panel to the distribution housing x 2).
- Add additional 3" when passing through a post. See the Tips at the beginning of the section for more details.
- Pass-Through Extension Cable connects to the end of a Pass-Through Cable to extend power capability beyond 208".

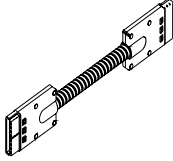
DESCRIPTION	PRODUCT CODE	LIST PRICE	DIMENSIONS/INCHES		
			H	L	D
 Pass-Through Cable	EVE8CP28	111	28	1/2	
	EVE8CP40	117	40	1/2	
	EVE8CP46	121	46	1/2	
	EVE8CP52	125	52	1/2	
	EVE8CP58	132	58	1/2	
	EVE8CP64	138	64	1/2	
	EVE8CP70	142	70	1/2	
	EVE8CP76	144	76	1/2	
	EVE8CP82	150	82	1/2	
	EVE8CP88	155	88	1/2	
	EVE8CP94	159	94	1/2	
	EVE8CP100	164	100	1/2	
	EVE8CP106	172	106	1/2	
	EVE8CP118	180	118	1/2	
	EVE8CP130	198	130	1/2	
	EVE8CP142	207	142	1/2	
	EVE8CP154	217	154	1/2	
	EVE8CP172	233	172	1/2	
	EVE8CP190	245	190	1/2	
	Pass-Through Extension Cable	EVE8CP208	253	208	1/2
EVE8CPF154		217	154	1/2	

## EVE8CI-1 - "I" CONNECTOR

- Female - Female connector used to connect two Pass-Through Cables

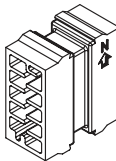
DESCRIPTION	PRODUCT CODE	LIST PRICE	DIMENSIONS/INCHES		
			H	W	D
 "I" Connector	EVE8CI-1	62			

## EVE8RD - DUPLEX RECEPTACLE

- Duplex receptacles are rated for 15 Amps.
- EVE8RD1 = Circuit #1 (utility circuit)
- EVE8RD2 = Circuit #2 (utility circuit)
- EVE8RDA = Circuit A (dedicated)
- EVE8RDB = Circuit B (dedicated)

### NOTE:

- EVE8RD1 and EVE8RD2 (#1 and #2 share common ground)
- EVE8RDA and EVE8RDB (A and B share common ground)
- Up to 6 receptacles per circuit (24 per infeed), not to exceed total of 15 Amps per circuit.
- Standard in black. Available in White or Nevada with upcharge, add \$3.00.

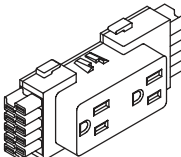
DESCRIPTION	PRODUCT CODE	LIST PRICE	DIMENSIONS/INCHES		
			H	W	D
 Duplex Receptacle	EVE8RD1	23	2	4 5/8	1 1/4
	EVE8RD2	23	2	4 5/8	1 1/4
	EVE8RDA	23	2	4 5/8	1 1/4
	EVE8RDB	23	2	4 5/8	1 1/4

# ELECTRICAL

## EVEUSB01 - USB MODULE

- Includes two USB ports.
- Available in White and Black.

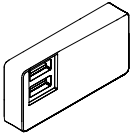
	DESCRIPTION	PRODUCT CODE	LIST PRICE	DIMENSIONS/INCHES		
				H	L	D
	USB Module - White	EVEUSB01WHT	150	2	4 5/8	1 1/4
	USB Module - Black	EVEUSB01BLK	150	2	4 5/8	1 1/4

## EVE8FR1 - REVERSIBLE FLOOR POWER ENTRY

- Takes the place of a duplex receptacle by snapping into the base power way or Beltline power way.
- Includes 72" long flexible vinyl conduit.
- Must be hard wired to source power by a licensed electrician.
- Diameter is 0.85"

## EVE8FR2 - REVERSIBLE FLOOR POWER ENTRY

- Takes the place of a duplex receptacle by snapping into the base power way or Beltline power way.
- Includes 144" long flexible vinyl conduit.
- Must be hard wired to source power by a licensed electrician.
- Diameter is 0.85"

	DESCRIPTION	PRODUCT CODE	LIST PRICE	DIMENSIONS/INCHES		
				H	L	D
	Reversible Floor Power Entry	EVE8FR1	246		72	
	Reversible Floor Power Entry	EVE8FR2	318		144	

## EVE8EC - CEILING POWER ENTRY

- Snaps into the end of a Power Distribution Housing.
- Flexible metal conduit extends into the ceiling through a corner post and post extension.
- Must be hard wired to source power by a licensed electrician.
- 4" junction box included.
- Post extension ordered separately
- Can feed directly into beltline power when Beltline Post Connectors are specified.
- Cannot feed through Inline or End-of-run Connectors.

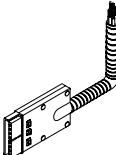
	DESCRIPTION	PRODUCT CODE	LIST PRICE	DIMENSIONS/INCHES		
				H	L	D
	Ceiling Power Entry	EVE8EC1	190		132	
		EVE8EC2	333		144	
		EVE8EC3	376		180	



# ELECTRICAL

## EVEENY-2 - HARDWARE POWER ENTRY BOX - NEW YORK

- A licensed electrician must provide hard wire connection within the junction box.
- Not for use in panels less than 36"W.

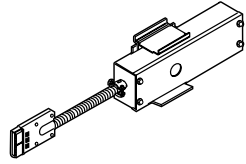

DESCRIPTION	PRODUCT CODE	LIST PRICE	DIMENSIONS/INCHES		
			H	W	D
Hardware Power Entry Box - New York	EVEENY2	315	3	28	2 1/5

## EVEJBC-1 - HARDWARE JUNCTION BOX - CHICAGO

- Can be retrofitted in any size of panel at the receptacle location.
- Gives access from one side only at each location.
- Customer to supply conduit, wiring, receptacle, and face plate.
- 2 per panel, except 24" panels only one is needed.
- A licensed electrician must provide hardware connection with the junction box.

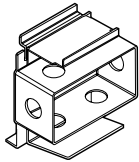

DESCRIPTION	PRODUCT CODE	LIST PRICE	DIMENSIONS/INCHES		
			H	W	D
Hardware Junction Box - Chicago	EVEJBC-1	70			

## EVDPE - POST EXTENSION DATA/COMM LAY-IN

- Attaches to the top of a post to bring power and/or data cables from the ceiling to the panel power way
- Three-sided power pole with snap-on fourth side.
- Post extension can be opened on one side for lay-in or power and/or data cables.
- Made of aluminum and can be field cut.
- Accommodates up to 25CAT 5 Cables with electric. Accommodates up to 45 CAT 5 Cables without electric.

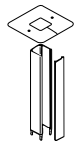

DESCRIPTION	PRODUCT CODE	LIST PRICE	DIMENSIONS/INCHES		
			H	W	D
Post Extension Data/Comm Lay-in	EVDPE64	121	64	2 7/8	
	EVDPE82	147	84	2 7/8	

## EVDPE6E - 60° POST EXTENSION DATA/COMM LAY-IN

- Attaches to the top of at 60° corner post to bring power and/or data cables from the ceiling to the panel power way.
- Two-sided power pole with snap-on third side.
- Post extension can be opened on one side for lay-in or power and/or data cables.
- Made of aluminum and can be field cut.
- Accommodates up to 6 CAT 5 Cables with electric. Accommodates up to 20 CAT 5 Cables without electric.



DESCRIPTION	PRODUCT CODE	LIST PRICE	DIMENSIONS/INCHES		
			H	W	D
60° Post Extension Data/Comm Lay-in	EVDPE6E64	121	64	2	
	EVDPE6E82	147	84	2	

# ELECTRICAL

## EVDP4E - 45° POST EXTENSION DATA/COMM LAY-IN

- Attaches to the top of at 45° corner post to bring power and/or data cables from the ceiling to the panel power way.
- Two-sided power pole with snap-on third side.
- Post extension can be opened on one side for lay-in or power and/or data cables.
- Made of aluminum and can be field cut.
- Accommodates up to 6 CAT 5 Cables with electric. Accommodates up to 20 CAT 5 Cables without electric.

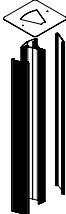
	DESCRIPTION	PRODUCT CODE	LIST PRICE	DIMENSIONS/INCHES		
				H	W	D
	45° Post Extension Data/Comm Lay-in	EVDP4E64	127	64	3.65	
		EVDP4E84	169	84	3.65	

## EVET5L - UNDER STORAGE LOW WATTAGE TASK LIGHT FOR ENVIRONMENTALLY FRIENDLY BENEFITS

- Task light must be at least 6" shorter than storage component to which it is attached.
- T5 rapid start fluorescent lamps
- Uses low wattage for energy efficient illumination
- Meets Chicago and NY electrical codes
- Electronic ballast
- Miniature rocker switch, positive position rocker
- 7 ft. black cord on all under storage models except 48". 48" models come with a 9 ft. cord.
- Available in black only
- Cannot be attached to Evolve 1600 Series Overhead Storage bins, without screws (not supplied).

	DESCRIPTION	PRODUCT CODE	LIST PRICE	DIMENSIONS/INCHES		
				H	W	D
	Under Storage Low Wattage Task Light for Environmentally Friendly Benefits	EVET5L18	136	1 1/4	19 1/5	4 1/4
		EVET5L24	143	1 1/4	24	4 1/4
		EVET5L36	153	1 1/4	36	4 1/4
		EVET5L48	171	1 1/4	48	4 1/4

## EVETL - UNDER STORAGE TASK LIGHT

- Task light must be at least 6" shorter than storage component to which it is attached.
- SP41 Rapid Start T8 lamp.
- Normal power factor ballast.
- 7 ft. black cord on all under storage models except 48". 48" models come with a 9 ft. cord.
- Available in black only.
- Cannot be attached to Evolve 1600 Series Overhead Storage bins, without screws (not supplied).

	DESCRIPTION	PRODUCT CODE	LIST PRICE	DIMENSIONS/INCHES		
				H	W	D
	Under Storage Task Light	EVETL18	194		19 1/2	
		EVETL24	211		24	
		EVETL36	231		36	
		EVETL48	247		48	



# ELECTRICAL

## EVELEDVS - VOYAGE LED SINGLE LIGHT FIXTURE

- Single arm option with 6 ft. cord.
- Touch & hold dimming capability.
- Brightness adjustment from 100% to 15%.
- Available in Designer White (WHT), Black (BLK) or Silver (SIL).
- Mercury free LEDs and 94% post consumer recyclability by weight.
- Mounting accessories sold separately.

	DESCRIPTION	PRODUCT CODE	LIST PRICE	DIMENSIONS/INCHES		
				H	W	D
	Voyage LED Single Light Fixture	EVELEDVS	511			
	Voyage LED Single Light Fixture w/Occupancy Sensor	EVELEDVSO	761			

## EVELEDVD - VOYAGE LED DOUBLE LIGHT FIXTURE

- Double arm option with 6 ft. cord.
- Touch & hold dimming capability.
- Brightness adjustment from 100% to 15%.
- Available in Designer White (WHT), Black (BLK) or Silver (SIL).
- Mercury free LEDs and 94% post consumer recyclability by weight.
- Mounting accessories sold separately.

	DESCRIPTION	PRODUCT CODE	LIST PRICE	DIMENSIONS/INCHES		
				H	W	D
	Voyage LED Double Light Fixture	EVELEDVD	521			
	Voyage LED Double Light Fixture w/Occupancy Sensor	EVELEDVDO	771			

## EVELEDRS - REVO LED SINGLE LIGHT FIXTURE

- Single arm option with 9 ft. cord.
- Touch & hold dimming capability.
- Brightness adjustment from 100% to 15%.
- Available in Designer White (WHT), Black (BLK) or Silver (SIL).
- Mercury free LEDs and 94% post consumer recyclability by weight.
- Mounting accessories sold separately.

	DESCRIPTION	PRODUCT CODE	LIST PRICE	DIMENSIONS/INCHES		
				H	W	D
	Revo LED Single Light Fixture	EVELEDRS	511			
	Revo LED Single Light Fixture w/Occupancy Sensor	EVELEDRSO	761			

## EVELEDRD - REVO LED DOUBLE LIGHT FIXTURE

- Double arm option with 9 ft. cord.
- Touch & hold dimming capability.
- Brightness adjustment from 100% to 15%.
- Available in Designer White (WHT), Black (BLK) or Silver (SIL).
- Mercury free LEDs and 94% post consumer recyclability by weight.
- Mounting accessories sold separately.

	DESCRIPTION	PRODUCT CODE	LIST PRICE	DIMENSIONS/INCHES		
				H	W	D
	Revo LED Double Light Fixture	EVELEDRD	521			
	Revo LED Double Light Fixture w/Occupancy Sensor	EVELEDRDO	771			



# ELECTRICAL

## EVELEDAFS - FREESTANDING BASE

DESCRIPTION	PRODUCT CODE	LIST PRICE	DIMENSIONS/INCHES		
			H	W	D
 Freestanding Base	EVELEDAFS	143			

## EVELEDACM - CLAMP MOUNT

DESCRIPTION	PRODUCT CODE	LIST PRICE	DIMENSIONS/INCHES		
			H	W	D
 Clamp Mount	EVELEDACM	129			

## EVELEDASW - SLATWALL MOUNT

DESCRIPTION	PRODUCT CODE	LIST PRICE	DIMENSIONS/INCHES		
			H	W	D
 Slatwall Mount	EVELEDASW	129			

## EVELEDAPM - PANEL MOUNT

DESCRIPTION	PRODUCT CODE	LIST PRICE	DIMENSIONS/INCHES		
			H	W	D
 Panel Mount	EVELEDAPM	129			

## EVELEDASM - SURFACE MOUNT

DESCRIPTION	PRODUCT CODE	LIST PRICE	DIMENSIONS/INCHES		
			H	W	D
 Surface Mount	EVELEDASM	129			



# ELECTRICAL

## EVECC - CORD COVER

- Attaches to panels vertically between modules to provide enclosures for power or data cords.
- Available in 21" and 36" lengths, 6 per pack.
- Can be field cut to required length.

	DESCRIPTION	PRODUCT CODE	LIST PRICE	DIMENSIONS/INCHES		
				H	W	D
	Inline Cord Cover	EVECC121	22	21		
	For use at panel Inline connections	EVECC136	33	36		
	Corner Cord Cover	EVECC221	22	21		
	For use at panel Inline connections	EVECC236	33	36		

## EVH8RC - RACEWAY COVERS

- Raceway Cover with 1.38" x 2.71" duplex receptacle openings.
- Raceway Covers are sold individually.
- Includes 2 receptacle opening shields.

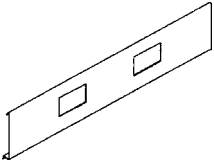
	DESCRIPTION	PRODUCT CODE	LIST PRICE	DIMENSIONS/INCHES		
				H	W	D
	Raceway Covers	EVH8RC18	14	6	18	
		EVH8RC24	23	6	24	
		EVH8RC30	31	6	30	
		EVH8RC36	35	6	36	
		EVH8RC42	39	6	42	
		EVH8RC48	43	6	48	
		EVH8RC54	50	6	54	
		EVH8RC60	55	6	60	



## EVEMAE - MINI-ADAPT POWER MODULE

- Attaches to scoop at the back of the worksurface.
- Available in black only.
- Includes two Simplex outlets.
- Note: Height (H) is measured above the worksurface.
- 6' black cord

	DESCRIPTION	PRODUCT CODE	LIST PRICE	DIMENSIONS/INCHES		
				H	W	D
	Mini-Adapt Power Module	EVEMAE1	156	2	3.58	3

## EVEMAD - MINI-ADAPT POWER MODULE

- Attaches to scoop at the back of the worksurface.
- Available in black only.
- Includes two Voice/Data Port, Voice/Data Adapter Kit.
- Note: Height (H) is measured above the worksurface.
- Accepts Cat3, Cat 5, Cat 5e, Cat 6 jacks.

	DESCRIPTION	PRODUCT CODE	LIST PRICE	DIMENSIONS/INCHES		
				H	W	D
 	Mini-Adapt Power Module	EVEMAD1	126	2	3.58	3

# ELECTRICAL

## EVEA - DESKTOP DATA/POWER RECEPTACLE

- Accessory Data/Power House
- Attaches to scoop at the back of a worksurface.
- Includes 2 Simplexes, 2 Voice/Data Ports Voice/Data Adapter Kit, 6' Power Cord
- Available in black only.
- Voice/Data jacks & cable not included.

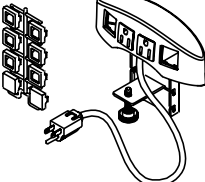
	DESCRIPTION	PRODUCT CODE	LIST PRICE	DIMENSIONS/INCHES		
				H	W	D
	Desktop Data/Power Receptacle	EVEA54	285	2.63	7 1/2	3

## EVEA - ADAPT POWER/DATA MODULE

### NOTE:

- Attaches to scoop at the back of a worksurface.
- Includes two Simplexes, two Voice/Data Ports, Voice/Data Adapter Kit, 6' Power Cord.
- Available in black polycarbonate only.
- Height (H) is measured above the worksurface

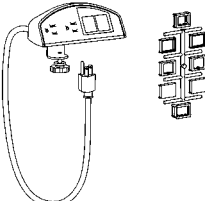
	DESCRIPTION	PRODUCT CODE	LIST PRICE	DIMENSIONS/INCHES		
				H	W	D
	Adapt Power/Data Module	EVEA44	265	2	3 5/8	3



# ELECTRICAL

## EVED - DUO POWER ADAPTER

- Includes two outlets and two USB ports.
- Clamp mounts above worksurface.
- Available in White only, with Tungsten support bracket.

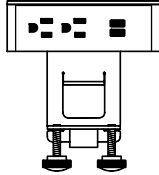
	DESCRIPTION	PRODUCT CODE	LIST PRICE	DIMENSIONS/INCHES		
				H	L	D
	Duo Power Adapter	EVED50	600	1.8	5.5	3.2

## EVEDU - DUO UNDER POWER ADAPTER

- Includes two outlets and two USB ports.
- Mounts underneath worksurface or table top with 4 screws.
- Available in White only.

	DESCRIPTION	PRODUCT CODE	LIST PRICE	DIMENSIONS/INCHES		
				H	L	D
	Duo Under Power Adapter	EVEDU51	525	1.8	6.5	2.8

## EVETP - TRIO POWER ADAPTER

- Includes three outlets, USB ports and data port.
- Clamp mounts above worksurface.
- Available in White only, with Tungsten support bracket.

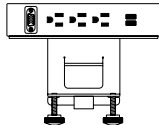
	DESCRIPTION	PRODUCT CODE	LIST PRICE	DIMENSIONS/INCHES		
				H	L	D
	Trio Power Adapter	EVETP53	675	1.8	8	3.2

## EVETPU - TRIO UNDER POWER ADAPTER

- Includes three outlets, USB ports and data port.
- Mounts underneath worksurface or table top with 4 screws.
- Available in White only.

	DESCRIPTION	PRODUCT CODE	LIST PRICE	DIMENSIONS/INCHES		
				H	L	D
	Trio Under Power Adapter	EVETPU55	630	1.8	8	3.9



worksurfaces

**THE INFORMATION LISTED BELOW PROVIDES YOU WITH BASIC FEATURES OF EVOLVE WORKSURFACES.**

- Evolve thermally fused worksurfaces are 1" thick, high pressure is 1 1/16" and 1 7/16" thick. These are finished with 3 mm PVC edging on all sides.
- Standard laminate offerings are available in thermally-fused (TF) and most high pressure laminates (HP). See laminate listings for details.
- Wood grain laminates on corner worksurfaces up to 42" available in laminate run diagonally for an upcharge. Otherwise, standard horizontal application of laminate will be used.
- To avoid unsatisfactory results in laminate application when attaching two corner surfaces side by side, select "WG" surfaces for matching grain.
- Some wood grain laminate worksurfaces will have matching wood grain PVC trim unless specified otherwise.
- The depth of the worksurface scoops are 1 1/8" when measured from the panel the worksurface is attached to.

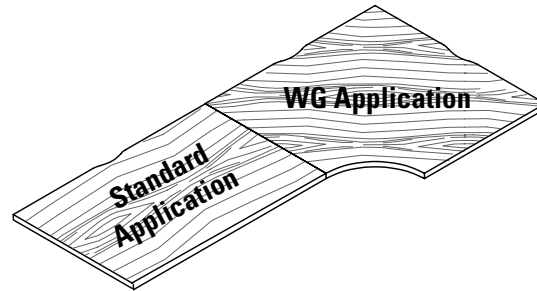

- All worksurfaces have threaded inserts for metal-to-metal connection for support hardware.
- All worksurfaces require support hardware. These are priced separately within this section.
- Communication and electrical wires are routed through a cable scoop located at the back of the worksurface. Depending on the specific surface, note that the number of cable scoops depends upon the width of the worksurface. All worksurface shapes have at least one scoop on the Panel edge.
- A 3/8" separation between the back of the worksurfaces and panels allows for cables to be moved to the panel seams and concealed by wire managers.
- Note: Wood veneer options for worksurfaces are available at an upcharge and with an extended lead time. Contact Evolve Customer Support for details.
- Tungsten (TUN) and Designer White (DWT) trim available at no charge.
- Note the following abbreviations:  
**TF = Thermally-Fused Laminate; (1") HP = High-Pressure Laminate (1 1/16"); HPW = High-Pressure Laminate (1 7/16"); WG = Wood Grain**

**One Scoop EVWS 24" - 48"**

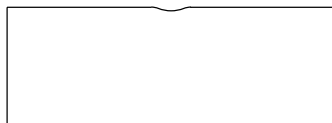

**Two Scoops EVWS 54" - 72"**

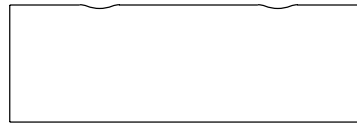

**One Scoop EVWL 24" - 48"**

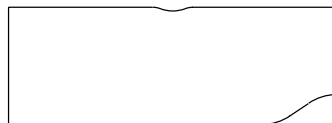

**Two Scoops EVWL 54" - 72"**

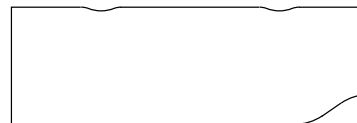

This page provides a three dimensional view of a sample configuration highlighting each **Worksurface** component required when specifying this configuration.

## Components

- A. EVWVL2436 Curvilinear Worksurface – Left  
Note: When deepest end equals 24", opposite depth is 18"  
When deepest end equals 30", opposite depth is 24"
- B. EVWCC3618 Corner Curved Worksurface
- C. EVWVR2436 Curvilinear Worksurface – Right
- D. EVWTEV1536 End Transaction Surface with Cut-out

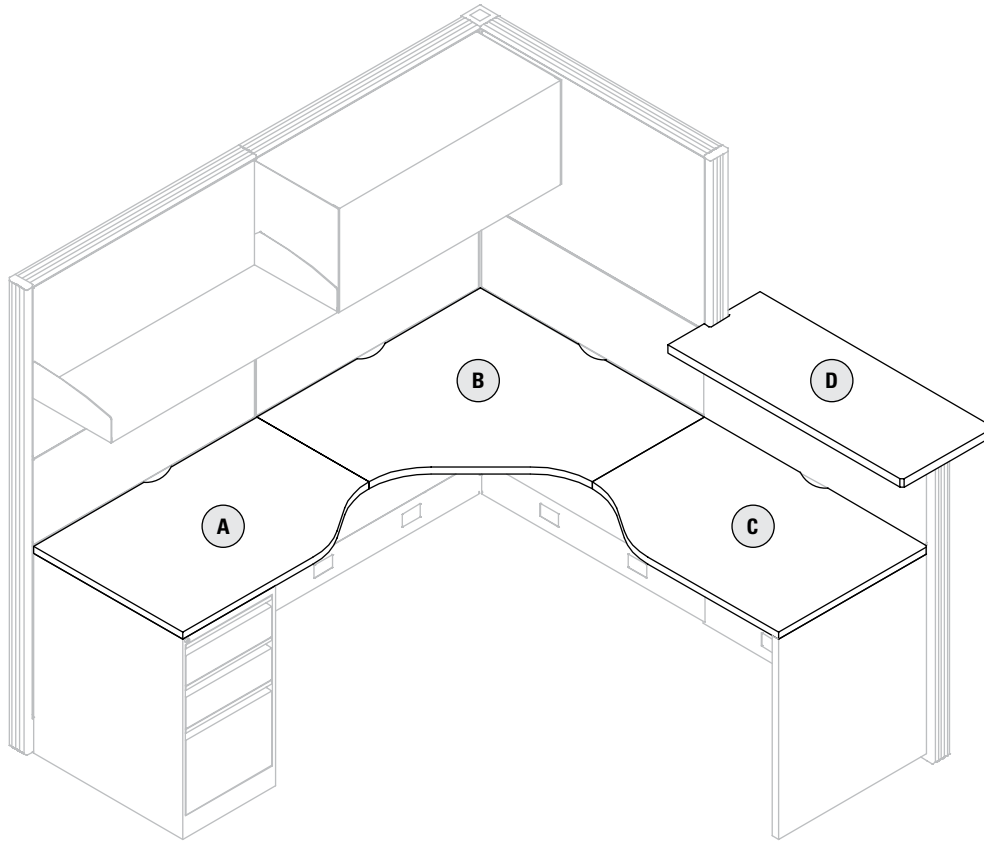



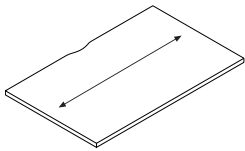

**EVWS Worksurfaces**

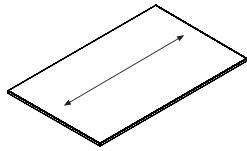

**EVWSNS Worksurfaces**

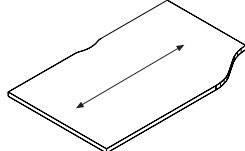

**EVWVR Worksurfaces**

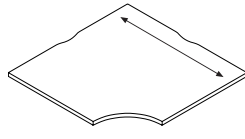

**EVWCC Worksurfaces**

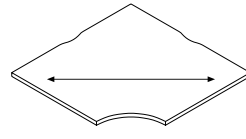

**EVWCCxxxWG Worksurfaces**

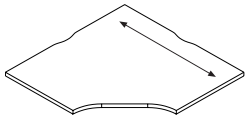

**EVWCK Worksurfaces**

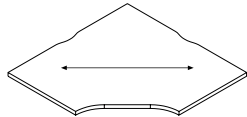

**EVWCKxxxWG Worksurfaces**



**EVWCF Worksurfaces**

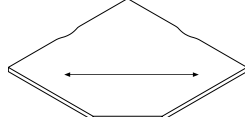

**EVWCFxxxWG Worksurfaces**

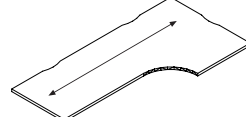

**EVWCE Worksurfaces**

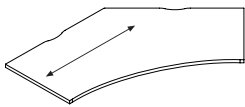

**EVWC4C Worksurfaces**

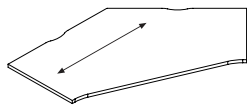

**EVWC4K Worksurfaces**

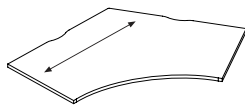

**EVWC6C Worksurfaces**

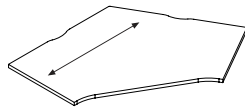

**EVWC6K Worksurfaces**

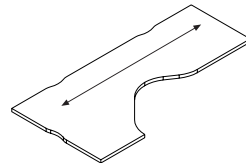

**EVWL Worksurfaces**

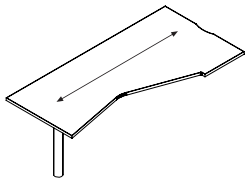

**EVWHL Worksurfaces**

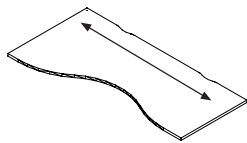

**EVWBTL/R Worksurfaces**

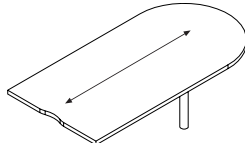

**EVWD Worksurfaces**

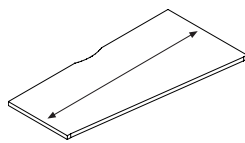

**EVWSWL/R Worksurfaces**

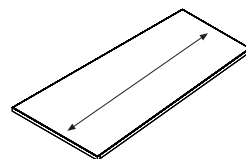

**EVWSWNSL/R Worksurfaces**

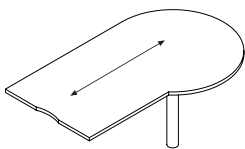

**EVWP Worksurfaces**

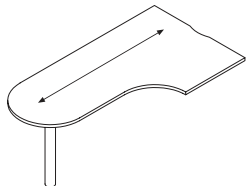

**EVWPL/R Worksurfaces**

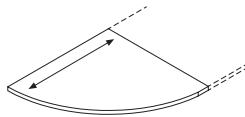

**EWWQR and EVWQRC Worksurfaces**

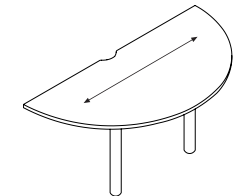

**EVWR Worksurfaces**

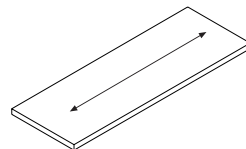

**EVWT, EVWTV, EVWTW, EWTEV, EVWTD, EVWTDV, EVWTDG Worksurfaces**

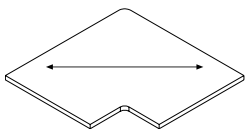

**EVWTCxxxWG Worksurfaces**

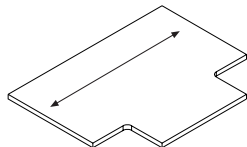

**EVWTC Worksurfaces**

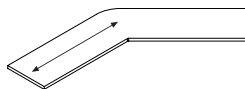

**EVW4T Worksurface**

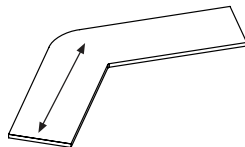

**EVW6T Worksurfaces**



# WORKSURFACES

## EVWS - STRAIGHT WORKSURFACE

- Support hardware must be ordered separately. See listing in this section of the price book.

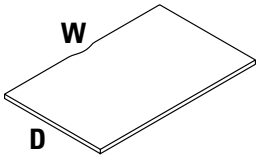
	DESCRIPTION	PRODUCT CODE	LIST PRICE			DIMENSIONS/INCHES		
			TF	HP	HPW	D	W	
	Straight Worksurface - 18" Deep	EVWS1824	96	132	198	18	24	
		EVWS1830	102	142	213	18	30	
		EVWS1836	116	159	239	18	36	
		EVWS1842	151	211	317	18	42	
		EVWS1848	182	252	379	18	48	
		EVWS1854	213	298	447	18	54	
		EVWS1860	239	332	499	18	60	
		EVWS1866	251	347	521	18	66	
		EVWS1872	261	362	542	18	72	
		EVWS1878	371	562	843	18	78	
		EVWS1884	399	606	909	18	84	
		EVWS1890	428	649	974	18	90	
		EVWS1896	456	692	1038	18	96	
		Straight Worksurface - 24" Deep	EVWS2424	98	134	201	24	24
			EVWS2430	105	144	216	24	30
EVWS2436	119		163	243	24	30		
EVWS2442	153		213	320	24	42		
EVWS2448	184		256	385	24	48		
EVWS2454	216		300	450	24	54		
EVWS2460	242		334	502	24	60		
EVWS2466	253		350	525	24	66		
EVWS2472	264		364	545	24	72		
EVWS2478	425		545	818	24	78		
EVWS2484	429		553	829	24	84		
EVWS2490	428		649	974	24	90		
EVWS2496	456		692	1038	24	96		
Straight Worksurface - 30" Deep	EVWS3024		116	158	237	30	24	
	EVWS3030		123	172	259	30	30	
	EVWS3036	146	200	301	30	36		
	EVWS3042	205	282	424	30	42		
	EVWS3048	216	300	450	30	48		
	EVWS3054	237	327	490	30	54		
	EVWS3060	253	350	525	30	60		
	EVWS3066	263	364	545	30	66		
	EVWS3072	278	386	580	30	72		
	EVWS3078	529	684	1025	30	78		
	EVWS3084	537	689	1034	30	84		
	EVWS3090	534	812	1218	30	90		
	EVWS3096	570	865	1298	30	96		

# WORKSURFACES

## EVWSNSC - STRAIGHT WORKSURFACE NO SCOOP

- There is no scoop on this work surface.
- Surfaces not available in HPW.
- Support hardware must be ordered separately. See listing in this section of the price book.

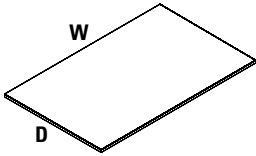
	DESCRIPTION	PRODUCT CODE	LIST PRICE		DIMENSIONS/INCHES	
			TF	HP	D	W
	Straight Worksurface No Scoops - 24" Deep	EVWSNSC2424	98	134	24	24
		EVWSNSC2430	105	144	24	30
		EVWSNSC2436	119	163	24	36
		EVWSNSC2442	153	213	24	42
		EVWSNSC2448	184	256	24	48
		EVWSNSC2454	216	300	24	54
		EVWSNSC2460	242	334	24	60
		EVWSNSC2466	253	350	24	66
		EVWSNSC2472	264	364	24	72
		EVWSNSC2478	425	545	24	78
		EVWSNSC2484	429	553	24	84
		EVWSNSC2490	428	649	24	90
		EVWSNSC2496	456	692	24	96
	Straight Worksurface No Scoops - 30" Deep	EVWSNSC3024	116	158	30	24
		EVWSNSC3030	123	172	30	30
		EVWSNSC3036	146	200	30	30
		EVWSNSC3042	205	282	30	42
		EVWSNSC3048	216	300	30	48
		EVWSNSC3054	237	327	30	54
EVWSNSC3060		253	350	30	60	
EVWSNSC3066		263	364	30	66	
EVWSNSC3072		278	386	30	72	
EVWSNSC3078		529	684	30	78	
EVWSNSC3084	537	689	30	84		
EVWSNSC3090	534	812	30	90		
EVWSNSC3096	570	865	30	96		



# WORKSURFACES

## EVWSP - STRAIGHT WORKSURFACE TO SPAN-A-POST

- Support hardware must be ordered separately. See listing in this section of the price book.

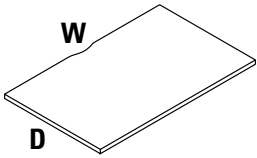
	DESCRIPTION	PRODUCT CODE	LIST PRICE			DIMENSIONS/INCHES	
			TF	HP	HPW	D	W
	Straight Worksurface to Span-a-Post - 18" Deep	EWWS1827	114	173	260	18	27
		EWWS1833	102	142	213	18	33
		EWWS1839	150	228	342	18	39
		EWWS1845	182	260	390	18	45
		EWWS1851	214	298	447	18	51
		EWWS1857	239	332	498	18	57
		EWWS1863	251	347	521	18	63
		EWWS1869	261	362	543	18	69
		EWWS1875	278	422	633	18	75
		EWWS1881	366	470	705	18	81
		EWWS1887	373	478	478	18	87
			Straight Worksurface to Span-a-Post - 24" Deep	EWWS2427	143	216	324
EWWS2433	171			260	390	24	33
EWWS2439	200			303	455	24	39
EWWS2445	228			346	519	24	42
EWWS2451	257			389	584	24	48
EWWS2457	285			433	650	24	57
EWWS2463	314			476	714	24	63
EWWS2469	342			519	779	24	69
EWWS2475	425			562	843	24	75
EWWS2481	429			606	909	24	81
EWWS2487	436			649	436	24	84
	Straight Worksurface to Span-a-Post - 30" Deep			EWWS3027	178	271	407
		EWWS3033	214	324	486	30	33
		EWWS3039	249	379	569	30	39
		EWWS3045	285	433	650	30	45
		EWWS3051	321	487	731	30	48
		EWWS3057	356	541	812	30	57
		EWWS3063	392	595	893	30	63
		EWWS3069	428	649	974	30	69
		EWWS3075	529	703	1055	30	75
		EWWS3081	537	718	1077	30	81
		EWWS3087	564	812	1218	30	87

# WORKSURFACES

## EVWVL - CURVILINEAR WORKSURFACE - LEFT

- When deepest end equals 24", the opposite depth is 18". When deepest end equals 30", the opposite depth is 24".
- Support hardware must be ordered separately. See listing in this section of the price book.

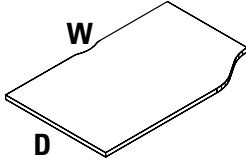
	DESCRIPTION	PRODUCT CODE	LIST PRICE			DIMENSIONS/INCHES	
			TF	HP	HPW	D	W
	Curvilinear Worksurface - 24" Deep	EVWVL2424	127	175	263	24	24
		EVWVL2430	132	181	273	24	30
		EVWVL2436	158	219	330	24	36
		EVWVL2442	184	256	385	24	42
		EVWVL2448	211	293	438	24	48
		EVWVL2454	237	327	490	24	54
		EVWVL2460	257	364	545	24	60
		EVWVL2466	284	399	599	24	66
		EVWVL2472	305	437	655	24	72
		EVWVL2478	425	545	818	24	78
	EVWVL2484	429	553	829	24	84	
	Curvilinear Worksurface - 30" Deep	EVWVL3024	132	181	273	30	24
		EVWVL3030	139	190	284	30	30
		EVWVL3036	166	234	350	30	36
		EVWVL3042	227	314	471	30	42
		EVWVL3048	237	327	490	30	48
		EVWVL3054	263	364	545	30	54
		EVWVL3060	284	399	599	30	60
		EVWVL3066	305	437	655	30	66
		EVWVL3072	324	472	708	30	72
		EVWVL3078	529	684	1025	30	78
		EVWVL3084	537	689	1034	30	84

## EVWVR - CURVILINEAR WORKSURFACE - RIGHT

- When deepest end equals 24", the opposite depth is 18". When deepest end equals 30", the opposite depth is 24".
- Support hardware must be ordered separately. See listing in this section of the price book.

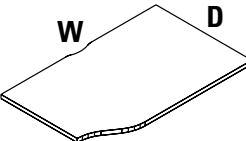
	DESCRIPTION	PRODUCT CODE	LIST PRICE			DIMENSIONS/INCHES	
			TF	HP	HPW	D	W
	Curvilinear Worksurface - 24" Deep	EVWVR2424	127	175	263	24	24
		EVWVR2430	132	181	273	24	30
		EVWVR2436	158	219	330	24	36
		EVWVR2442	184	256	385	24	42
		EVWVR2448	211	293	438	24	48
		EVWVR2454	237	327	490	24	54
		EVWVR2460	257	364	545	24	60
		EVWVR2466	284	399	599	24	66
		EVWVR2472	305	437	655	24	72
		EVWVR2478	425	545	818	24	78
	EVWVR2484	429	553	829	24	84	
	Curvilinear Worksurface - 30" Deep	EVWVR3024	132	181	273	30	24
		EVWVR3030	139	190	284	30	30
		EVWVR3036	166	234	350	30	36
		EVWVR3042	227	314	471	30	42
		EVWVR3048	237	327	490	30	48
		EVWVR3054	263	364	545	30	54
		EVWVR3060	284	399	599	30	60
		EVWVR3066	305	437	655	30	66
		EVWVR3072	324	472	708	30	72
		EVWVR3078	529	684	1025	30	78
		EVWVR3084	537	689	1034	30	84



# WORKSURFACES

## EVWCC - CORNER CURVED WORKSURFACE

- When specifying woodgrain laminate (WG) for corner worksurfaces 42" wide or less, choose from a diagonally run grain for an upcharge or standard application at no upcharge.
- Support hardware must be ordered separately. See listings in this section.

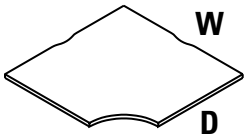
	DESCRIPTION	PRODUCT CODE	LIST PRICE			DIMENSIONS/INCHES	
			TF	HP	HPW	D	W
	Corner Curved Worksurface - 36"	EWCC3618	334	441	662	18	36
		EWCC3624	366	485	729	24	36
		EWCC3618WG	373	493	740	18	36
		EWCC3624WG	411	543	815	24	36
	Corner Curved Worksurface - 42"	EWCC4224	496	656	986	24	42
		EWCC4230	539	711	1066	30	42
		EWCC4224WG	555	766	1151	24	42
		EWCC4230WG	604	796	1194	30	42
	Corner Curved Worksurface - 48"	EWCC4824	579	752	1128	24	48
		EWCC4830	607	867	1301	30	48

## EVWCC - CORNER ASYMMETRICAL WORKSURFACE

- When specifying woodgrain laminate (WG) for corner worksurfaces 42" wide or less, choose from a diagonally run grain for an upcharge or standard application at no upcharge.
- Support hardware must be ordered separately. See listings in this section.

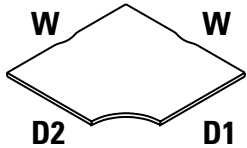
	DESCRIPTION	PRODUCT CODE	LIST PRICE			DIMENSIONS/INCHES		
			TF	HP	HPW	D1	D2	W
	Corner Worksurface - 36" x 36" x 18" x 24"	EWCC36361824	371	457	687	18	24	36
		EWCC36362418	371	457	687	24	18	36
		EWCC36361824WG	415	512	768	18	24	36
		EWCC36362418WG	415	512	768	24	18	36
	Corner Worksurface - 36" x 36" x 24" x 30"	EWCC36362430	401	483	726	24	30	36
		EWCC36363024	401	483	726	30	24	36
		EWCC36362430WG	449	541	812	24	30	36
		EWCC36363024WG	449	541	812	30	24	36
	Corner Worksurface - 42" x 42" x 18" x 24"	EWCC42421824	507	679	1019	18	24	42
		EWCC42422418	507	679	1019	24	18	42
		EWCC42421824WG	568	761	1142	18	24	42
		EWCC42422418WG	568	761	1142	24	18	42
	Corner Worksurface - 42" x 42" x 24" x 30"	EWCC42422430	548	847	1271	24	30	42
		EWCC42423024	548	847	1271	30	24	42
		EWCC42422430WG	614	948	1421	24	30	42
		EWCC42423024WG	614	948	1421	30	24	42
	Corner Worksurface - 48" x 48" x 24" x 30"	EWCC48482430	701	963	1444	24	30	42
		EWCC48483024	701	963	1444	30	24	42

# WORKSURFACES

## EVWCK - CORNER KEYBOARD WORKSURFACE

- When specifying woodgrain laminate (WG) for corner worksurfaces 42" wide or less, choose from a diagonally run grain for an upcharge or standard application at no upcharge.
- Support hardware must be ordered separately. See listings in this section.

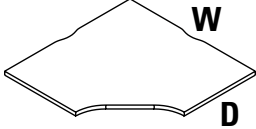
	DESCRIPTION	PRODUCT CODE	LIST PRICE			DIMENSIONS/INCHES	
			TF	HP	HPW	D	W
	Corner Keyboard Worksurface - 36"	EWWCK3618	340	448	672	18	36
		EWWCK3624	437	558	837	24	36
		EWWCK3618WG	381	502	753	18	36
		EWWCK3624WG	490	625	937	24	36
	Corner Keyboard Worksurface - 42"	EWWCK4224	501	665	998	24	42
		EWWCK4230	571	786	1180	30	42
		EWWCK4224WG	561	744	1117	24	42
		EWWCK4230WG	639	881	1320	30	42
	Corner Keyboard Worksurface - 48"	EWWCK4824	611	874	1313	24	48
		EWWCK4830	680	959	1440	30	48

## EVWCF - FIVE-SIDED WORKSURFACE

- When specifying woodgrain laminate (WG) for corner worksurfaces 42" wide or less, choose from a diagonally run grain for an upcharge or standard application at no upcharge.
- Support hardware must be ordered separately. See listings in this section.

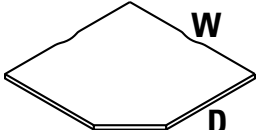
	DESCRIPTION	PRODUCT CODE	LIST PRICE			DIMENSIONS/INCHES	
			TF	HP	HPW	D	W
	Five-Sided Keyboard Worksurface - 36"	EWWCF3012	231	299	308	12	30
	Five-Sided Keyboard Worksurface - 36"	EWWCF3612	308	396	408	12	30
		EWWCF3618	334	441	662	18	36
		EWWCF3624	366	485	729	24	36
		EWWCF3618WG	373	494	742	18	36
	EWWCF3624WG	411	543	815	24	36	
	Five-Sided Keyboard Worksurface - 42"	EWWCF4224	496	656	986	24	42
		EWWCF4230	539	711	1066	30	42
		EWWCF4224WG	554	734	1102	24	42
		EWWCF4230WG	604	795	1193	30	42
	Five-Sided Keyboard Worksurface - 48"	EWWCF4824	579	752	1128	24	48
		EWWCF4830	607	867	1301	30	48



# WORKSURFACES

## EVWCCEL - EXTENDED CURVED CORNER - LEFT

- There are three cable scoops on this worksurface.
- Support hardware must be ordered separately. See listing in this section of the price book.
- Wood Grain Laminates do not run diagonally on Extended Curved Corners.

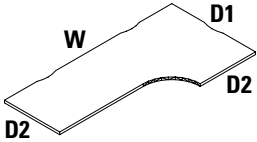
	DESCRIPTION	PRODUCT CODE	LIST PRICE			DIMENSIONS/INCHES		
			TF	HP	HPW	D1	D2	W
	Extended Curved Corner - 36" x 24"	EVWCCEL362448	453	579	868	36	24	48
		EVWCCEL362460	494	633	951	36	24	60
		EVWCCEL362466	543	697	1046	36	24	66
		EVWCCEL362472	601	773	1159	36	24	72
		EVWCCEL362478	642	825	1238	36	24	78
		EVWCCEL362484	691	889	1334	36	24	84
	Extended Curved Corner - 42" x 24"	EVWCCEL422460	520	666	999	42	24	60
		EVWCCEL422466	571	735	1103	42	24	66
		EVWCCEL422472	632	812	1216	42	24	72
		EVWCCEL422478	675	867	1301	42	24	78
		EVWCCEL422484	728	935	1404	42	24	84
	Extended Curved Corner - 42" x 30"	EVWCCEL423060	585	754	1131	42	30	60
		EVWCCEL423066	642	825	1238	42	30	66
		EVWCCEL423072	701	901	1352	42	30	72
		EVWCCEL423078	752	966	1449	42	30	78
		EVWCCEL423084	801	1030	1544	42	30	84
	Extended Curved Corner - 48" x 24"	EVWCCEL482460	616	762	1144	48	24	60
		EVWCCEL482466	666	849	1274	48	24	66
		EVWCCEL482472	715	927	1391	48	24	72
		EVWCCEL482478	786	990	1485	48	24	78
		EVWCCEL482484	818	1050	1574	48	24	84
	Extended Curved Corner - 48" x 30"	EVWCCEL483060	651	838	1258	48	30	60
		EVWCCEL483066	709	915	1372	48	30	66
		EVWCCEL483072	770	991	1486	48	30	72
		EVWCCEL483078	827	1065	1599	48	30	78
		EVWCCEL483084	873	1125	1687	48	30	84



# WORKSURFACES

## EVWCER - EXTENDED CURVED CORNER - RIGHT

- There are three cable scoops on this worksurface.
- Support hardware must be ordered separately. See listing in this section of the price list.
- Wood Grain Laminates do not run diagonally on Extended Curved Corners.

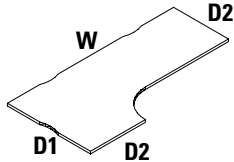
	DESCRIPTION	PRODUCT CODE	LIST PRICE			DIMENSIONS/INCHES		
			TF	HP	HPW	D1	D2	W
	Extended Curved Corner - 36" x 24"	EVWCER362448	453	579	868	36	24	48
		EVWCER362460	494	633	951	36	24	60
		EVWCER362466	543	697	1046	36	24	66
		EVWCER362472	601	773	1159	36	24	72
		EVWCER362478	642	825	1238	36	24	78
		EVWCER362484	691	889	1334	36	24	84
	Extended Curved Corner - 42" x 24"	EVWCER422460	520	666	999	42	24	60
		EVWCER422466	571	735	1103	42	24	66
		EVWCER422472	632	812	1216	42	24	72
		EVWCER422478	675	867	1301	42	24	78
		EVWCER422484	728	935	1404	42	24	84
			Extended Curved Corner - 42" x 30"	EVWCER423060	585	754	1131	42
EVWCER423066	642			825	1238	42	30	66
EVWCER423072	701			901	1352	42	30	72
EVWCER423078	752			966	1449	42	30	78
EVWCER423084	801			1030	1544	42	30	84
	Extended Curved Corner - 48" x 24"			EVWCER482460	616	762	1144	48
		EVWCER482466	666	849	1274	48	24	66
		EVWCER482472	715	927	1391	48	24	72
		EVWCER482478	786	990	1485	48	24	78
		EVWCER482484	818	1050	1574	48	24	84
			Extended Curved Corner - 48" x 30"	EVWCER483060	651	838	1258	48
EVWCER483066	709			915	1372	48	30	66
EVWCER483072	770			991	1486	48	30	72
EVWCER483078	827			1065	1599	48	30	78
EVWCER483084	873			1125	1687	48	30	84

## EVWC4C - CURVED CORNER SURFACE FOR 45° POST

- Support hardware must be ordered separately. See the listing in this section.

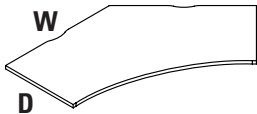
	DESCRIPTION	PRODUCT CODE	LIST PRICE			DIMENSIONS/INCHES	
			TF	HP	HPW	D	W
	Corner Curved Surface for 45° Post - 18"	EVWC4C1824	319	411	617	18	24
		EVWC4C1830	492	633	951	18	30
		EVWC4C1836	701	903	1355	18	36
		EVWC4C1842	875	1127	1690	18	42
		EVWC4C1848	1021	1314	1971	18	48
	Corner Curved Surface for 45° Post - 24"	EVWC4C2424	383	493	740	24	24
		EVWC4C2430	574	740	1109	24	30
		EVWC4C2436	802	1033	1550	24	36
		EVWC4C2442	875	1127	1690	24	42
		EVWC4C2448	1149	1478	2219	24	48
	Corner Curved Surface for 45° Post - 30"	EVWC4C3024	446	576	863	30	24
		EVWC4C3030	709	845	1268	30	30
		EVWC4C3036	802	1033	1550	30	36
		EVWC4C3042	984	1268	1901	30	42
		EVWC4C3048	1276	1643	2465	30	48



# WORKSURFACES

## EVWC4K - KEYBOARD CORNER SURFACE FOR 45° POST

- Support hardware must be ordered separately. See the listing in this section.

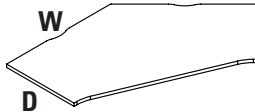
	DESCRIPTION	PRODUCT CODE	LIST PRICE			DIMENSIONS/INCHES	
			TF	HP	HPW	D	W
	Keyboard Curved Surface for 45° Post - 18"	EVWC4K1824	319	411	617	18	24
		EVWC4K1830	492	525	788	18	30
		EVWC4K1836	701	915	1372	18	36
		EVWC4K1842	875	1127	1690	18	42
		EVWC4K1848	1021	1314	1971	18	48
	Keyboard Curved Surface for 45° Post - 24"	EVWC4K2424	383	493	740	24	24
		EVWC4K2430	574	740	1109	24	30
		EVWC4K2436	802	1033	1550	24	36
		EVWC4K2442	875	1127	1690	24	42
		EVWC4K2448	1149	1478	2219	24	48
Keyboard Curved Surface for 45° Post - 30"	EVWC4K3024	446	576	863	30	24	
	EVWC4K3030	656	845	1268	30	30	
	EVWC4K3036	802	1033	1550	30	36	
	EVWC4K3042	984	1268	1901	30	42	
	EVWC4K3048	1276	1643	2465	30	48	

## EVWC6C - CURVED CORNER SURFACE FOR 60° POST

- Support hardware must be ordered separately. See the listing in this section.

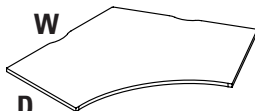
	DESCRIPTION	PRODUCT CODE	LIST PRICE			DIMENSIONS/INCHES	
			TF	HP	HPW	D	W
	Curved Curved Surface for 60° Post - 18"	EVWC6C1824	255	340	510	18	24
		EVWC6C1830	400	453	680	18	30
		EVWC6C1836	601	680	1021	18	36
		EVWC6C1842	734	831	1248	18	42
		EVWC6C1848	1001	1134	1703	18	48
	Curved Curved Surface for 60° Post - 24"	EVWC6C2424	300	341	512	24	24
		EVWC6C2430	533	605	907	24	30
		EVWC6C2436	601	680	1021	24	36
		EVWC6C2442	918	1039	1559	24	42
		EVWC6C2448	1001	1134	1703	24	48
Curved Curved Surface for 60° Post - 30"	EVWC6C3024	300	341	512	30	24	
	EVWC6C3030	533	605	907	30	30	
	EVWC6C3036	601	680	1021	30	36	
	EVWC6C3042	918	1039	1559	30	42	
	EVWC6C3048	1001	1134	1703	30	48	

## EVWC6K - CURVED CORNER SURFACE FOR 60° POST

- Support hardware must be ordered separately. See the listing in this section.

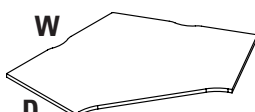
	DESCRIPTION	PRODUCT CODE	LIST PRICE			DIMENSIONS/INCHES	
			TF	HP	HPW	D	W
	Keyboard Curved Surface for 60° Post - 18"	EVWC6K1824	250	283	425	18	24
		EVWC6K1830	400	453	680	18	30
		EVWC6K1836	601	680	1021	18	36
		EVWC6K1842	734	831	1248	18	42
		EVWC6K1848	1001	1134	1703	18	48
	Keyboard Curved Surface for 60° Post - 24"	EVWC6K2430	533	605	907	24	30
		EVWC6K2436	601	680	1021	24	36
		EVWC6K2442	918	1039	1559	24	42
		EVWC6K2448	1001	1134	1703	24	48
		Keyboard Curved Surface for 60° Post - 30"	EVWC6K3030	533	605	907	30
EVWC6K3036	599		797	1196	30	36	
EVWC6K3042	819		1093	1639	30	42	
EVWC6K3048	992		1331	1995	30	48	

# WORKSURFACES

## EVWL - "L" WORKSURFACE

- There are three cable scoops on this worksurface.
- Support hardware must be ordered separately. See listing in this section of the price list.
- Must be specified either left or right handed.
- Wood Grain Laminates do not run diagonally on Extended Curved Corners.

DESCRIPTION	PRODUCT CODE	LIST PRICE			DIMENSIONS/INCHES	
		TF	HP	HPW	D	W
"L" Worksurface	EWLL2472	513	705	1057	24	72
	EWLNR2472	513	705	1057	24	72

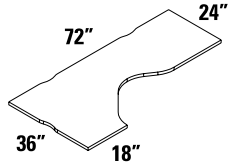

Right shown

## EVWBT - 30" TRANSITION WORKSURFACE

- Support hardware must be ordered separately. See the listing in this section of the price list.
- Opposing side of 30" deep (D1) Transition Worksurface has depth of 24" (D2).
- Scoops located on back edge only.
- Must be specified as right or left handed.

DESCRIPTION	PRODUCT CODE	LIST PRICE			DIMENSIONS/INCHES		
		TF	HP	HPW	D1	D2	W
Transition Worksurface - Left - 30"	EVWBTL3060	404	520	781	30	24	60
	EVWBTL3066	445	572	858	30	24	66
	EVWBTL3072	485	625	938	30	24	72
Transition Worksurface - Right - 30"	EVWBTR3060	404	520	781	30	24	60
	EVWBTR3066	445	572	858	30	24	66
	EVWBTR3072	485	625	938	30	24	72

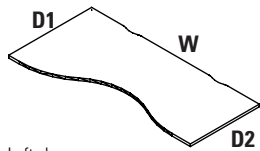

Left shown

## EVWBT - 36" TRANSITION WORKSURFACE

- Support hardware must be ordered separately. See the listing in this section of the price list.
- Opposing side of 36" deep (D1) Transition Worksurface has depth of 30" (D2).
- Scoops located on back edge only.
- Must be specified as right or left handed.

DESCRIPTION	PRODUCT CODE	LIST PRICE			DIMENSIONS/INCHES		
		TF	HP	HPW	D1	D2	W
Transition Worksurface - Left - 36"	EVWBTL3660	485	625	938	36	30	60
	EVWBTL3666	533	687	1031	36	30	66
	EVWBTL3672	582	750	1125	36	30	72
Transition Worksurface - Right - 36"	EVWBTR3660	485	625	938	36	30	60
	EVWBTR3666	533	687	1031	36	30	66
	EVWBTR3672	582	750	1125	36	30	72

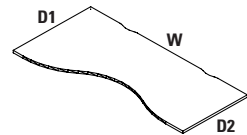

Left shown

## EVWSH - HATCHET WORKSURFACE

- Cable scoop is in the center of the 36" wide edge.
- Support hardware must be ordered separately. See listing in this section of the price list.
- Monoleg is included.
- Must be specified either left or right handed.
- Wood Grain Laminates do not run diagonally on Extended Curved Corners.

DESCRIPTION	PRODUCT CODE	LIST PRICE			DIMENSIONS/INCHES		
		TF	HP	HPW	D1	D2	W
Hatchet Worksurface - Left	EVWSHL3672	784	1010	1515	36	30	72
Hatchet Worksurface - Right	EVWSHR3672	784	1010	1515	36	30	72

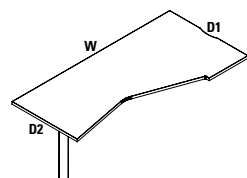

Right shown



# WORKSURFACES

## EVWD - "D" WORKSURFACE

- Support hardware must be ordered separately. See listing in this section of the price list.
- Monoleg is included

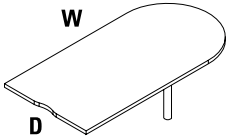
	DESCRIPTION	PRODUCT CODE	LIST PRICE			DIMENSIONS/INCHES	
			TF	HP	HPW	D	W
	"D" Worksurface - 24"	EVWD2442	366	510	764	24	42
		EVWD2448	378	521	782	24	48
		EVWD2460	396	547	821	24	60
		EVWD2472	425	589	885	24	72
	"D" Worksurface - 30"	EVWD3048	403	563	846	30	48
		EVWD3060	425	589	885	30	60
		EVWD3072	470	652	979	30	72

## EVWPTR - "P" TOP - RIGHT

- There is one scoop on this worksurface.
- Must be specified either left or right handed.
- Support hardware must be ordered separately. See listing in this section of the price book.
- Monoleg is included.

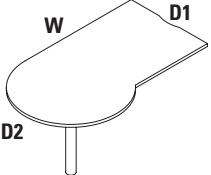
	DESCRIPTION	PRODUCT CODE	LIST PRICE			DIMENSIONS/INCHES		
			TF	HP	HPW	D1	D2	W
	"P" Top Worksurface - 24"	EVWPTR245430	561	723	1086	24	30	54
		EVWPTR246030	602	762	1144	24	30	60
		EVWPTR246630	630	802	1204	24	30	66
		EVWPTR247230	665	843	1264	24	30	72
	"P" Top Worksurface - 30"	EVWPTL306036	665	837	1256	30	36	60
		EVWPTL306636	718	885	1327	30	36	66
		EVWPTL307236	768	928	1392	30	36	72

## EVWPTL - "P" TOP - LEFT

- There is one scoop on this worksurface.
- Must be specified either left or right handed.
- Support hardware must be ordered separately. See listing in this section of the price book.
- Monoleg is included.

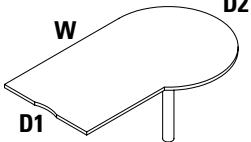
	DESCRIPTION	PRODUCT CODE	LIST PRICE			DIMENSIONS/INCHES		
			TF	HP	HPW	D1	D2	W
	"P" Top Worksurface - 24"	EVWPTL245430	561	723	1086	24	30	54
		EVWPTL246030	602	762	1144	24	30	60
		EVWPTL246630	630	802	1204	24	30	66
		EVWPTL247230	665	843	1264	24	30	72
	"P" Top Worksurface - 30"	EVWPTL306036	665	837	1256	30	36	60
		EVWPTL306636	718	885	1327	30	36	66
		EVWPTL307236	768	928	1392	30	36	72

# WORKSURFACES

## EVWSW - STRAIGHT WEDGE WORKSURFACES

- There is one scoop on this worksurface.
- Must be specified either left or right handed.
- Support hardware must be ordered separately. See listing in this section of the price book.

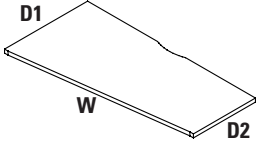
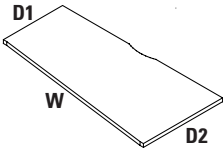
	DESCRIPTION	PRODUCT CODE	LIST PRICE			DIMENSIONS/INCHES			
			TF	HP	HPW	D1	D2	W	
	Straight Wedge Worksurface - Left	EVWSW241848	258	331	496	24	18	48	
		EVWSW241854	290	373	560	24	18	54	
		EVWSW241860	321	415	623	24	18	60	
		EVWSW241866	355	456	685	24	18	66	
		EVWSW241872	386	499	749	24	18	72	
			EVWSW302448	321	415	623	30	24	48
			EVWSW302454	362	467	699	30	24	54
			EVWSW302460	403	518	778	30	24	60
			EVWSW302466	443	570	856	30	24	66
			EVWSW302472	484	622	933	30	24	72
	Straight Wedge Worksurface - Right	EVWSW182448	258	331	496	18	24	48	
		EVWSW182454	290	373	560	18	24	54	
		EVWSW182460	321	415	623	18	24	60	
		EVWSW182466	355	456	685	18	24	66	
		EVWSW182472	386	499	749	18	24	72	
			EVWSW243048	321	415	623	24	30	48
			EVWSW243054	362	467	699	24	30	54
			EVWSW243060	403	518	778	24	30	60
			EVWSW243066	443	570	856	24	30	66
			EVWSW243072	484	622	933	24	30	72

## EVWSWNSC - STRAIGHT WEDGE WORKSURFACES NO SCOOPS

- There is no scoop on this worksurface.
- Support hardware must be ordered separately. See listing in this section of the price book.
- Must be specified either left or right handed.
- Surfaces not available in HPW.

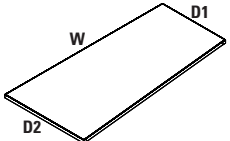
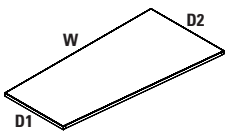
	DESCRIPTION	PRODUCT CODE	LIST PRICE		DIMENSIONS/INCHES			
			TF	HP	D1	D2	W	
	Straight Wedge Worksurface No Scoops - Left	EVWSWNSC241848	258	331	24	18	48	
		EVWSWNSC241854	290	373	24	18	54	
		EVWSWNSC241860	321	415	24	18	60	
		EVWSWNSC241866	355	456	24	18	66	
		EVWSWNSC241872	386	499	24	18	72	
			EVWSWNSC302448	321	415	30	24	48
			EVWSWNSC302454	362	467	30	24	54
			EVWSWNSC302460	403	518	30	24	60
			EVWSWNSC302466	443	570	30	24	66
			EVWSWNSC302472	484	622	30	24	72
	Straight Wedge Worksurface No Scoops - Right	EVWSWNSC182448	258	331	18	24	48	
		EVWSWNSC182454	290	373	18	24	54	
		EVWSWNSC182460	321	415	18	24	60	
		EVWSWNSC182466	355	456	18	24	66	
		EVWSWNSC182472	386	499	18	24	72	
			EVWSWNSC243048	321	415	24	30	48
			EVWSWNSC243054	362	467	24	30	54
			EVWSWNSC243060	403	518	24	30	60
			EVWSWNSC243066	443	570	24	30	66
			EVWSWNSC243072	484	622	24	30	72



# WORKSURFACES

## EVWPL - PIANO TOP - LEFT

- There is one scoop on this worksurface. Monoleg is included.
- Wood Grain Laminates do not run diagonally on Extended Curved Corners
- Support hardware must be ordered separately. See listing in this section of the price book.

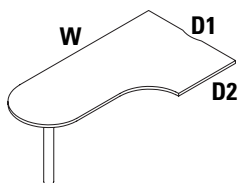
	DESCRIPTION	PRODUCT CODE	LIST PRICE			DIMENSIONS/INCHES		
			TF	HP	HPW	D1	D2	W
	Piano Top - Left - 36" x 18"	EVWPL361848	509	671	1006	36	18	48
		EVWPL361854	557	711	1066	36	18	54
		EVWPL361860	601	753	1129	36	18	60
		EVWPL361866	647	793	1190	36	18	66
		EVWPL361872	690	833	1249	36	18	72
	Piano Top - Left - 36" x 24"	EVWPL362448	513	675	1012	36	24	48
		EVWPL362454	561	715	1073	36	24	54
		EVWPL362460	606	756	1134	36	24	60
		EVWPL362466	652	798	1197	36	24	66
		EVWPL362472	694	837	1256	36	24	72
Piano Top - Left - 42" x 24"	EVWPL422454	690	771	1158	42	24	54	
	EVWPL422460	732	816	1224	42	24	60	
	EVWPL422466	810	865	1298	42	24	66	
	EVWPL422472	860	908	1363	42	24	72	
Piano Top - Left - 42" x 30"	EVWPL423060	749	834	1251	42	30	60	
	EVWPL423066	828	882	1323	42	30	66	
	EVWPL423072	877	929	1394	42	30	72	
Piano Top - Left - 48" x 24"	EVWPL482460	775	935	1404	48	24	60	
	EVWPL482466	859	991	1486	48	24	66	
	EVWPL482472	910	1048	1573	48	24	72	
Piano Top - Left - 48" x 30"	EVWPL483066	863	994	1491	48	30	66	
	EVWPL483072	915	1053	1579	48	30	72	

## EVWPR - PIANO TOP - RIGHT

- There is one scoop on this worksurface.
- Monoleg is included.
- Support hardware must be ordered separately. See listing in this section of the price book.

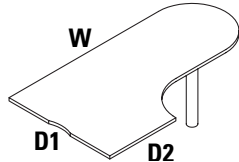
	DESCRIPTION	PRODUCT CODE	LIST PRICE			DIMENSIONS/INCHES		
			TF	HP	HPW	D1	D2	W
	Piano Top - Right - 36" x 18"	EVWPR361848	509	671	1006	36	18	48
		EVWPR361854	557	711	1066	36	18	54
		EVWPR361860	601	753	1129	36	18	60
		EVWPR361866	647	793	1190	36	18	66
		EVWPR361872	690	833	1249	36	18	72
	Piano Top - Right - 36" x 24"	EVWPR362448	513	675	1012	36	24	48
		EVWPR362454	561	715	1073	36	24	54
		EVWPR362460	606	756	1134	36	24	60
		EVWPR362466	652	798	1197	36	24	66
		EVWPR362472	694	837	1256	36	24	72
Piano Top - Right - 42" x 24"	EVWPR422454	690	771	1158	42	24	54	
	EVWPR422460	732	816	1224	42	24	60	
	EVWPR422466	810	865	1298	42	24	66	
	EVWPR422472	860	908	1363	42	24	72	
Piano Top - Right - 42" x 30"	EVWPR423060	749	834	1251	42	30	60	
	EVWPR423066	828	882	1323	42	30	66	
	EVWPR423072	877	929	1394	42	30	72	
Piano Top - Right - 48" x 24"	EVWPR482460	775	935	1404	48	24	60	
	EVWPR482466	859	991	1486	48	24	66	
	EVWPR482472	910	1048	1573	48	24	72	
Piano Top - Right - 48" x 30"	EVWPR483066	863	994	1491	48	30	66	
	EVWPR483072	915	1053	1579	48	30	72	

# WORKSURFACES

## EVWQR - QUARTER ROUND PANEL WORKSURFACE

- The worksurface edge running along the panel is a slightly different length than that of the worksurface end, causing the surface to be handed.
- Left hand surface shown.
- The user edge abutting the adjacent worksurface runs straight for 3" before starting to curve.
- Support hardware must be ordered separately. See listing in this section of the price book.

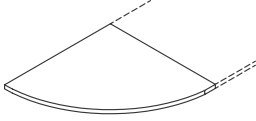
	DESCRIPTION	PRODUCT CODE	LIST PRICE			DIMENSIONS/INCHES	
			TF	HP	HPW	D	W
	Quarter Round Panel Worksurface - Left	EWQRL1818	109	144	216	18	18
		EWQRL2424	153	204	307	24	24
		EWQRL3030	202	263	394	30	30
	Quarter Round Panel Worksurface - Right	EWQRR1818	109	144	216	18	18
		EWQRR2424	153	204	307	24	24
		EWQRR3030	202	263	394	30	30

## EVWQRC - QUARTER ROUND PANEL CORNER WORKSURFACE

- Wraps around a 90° corner post.
- The user edge abutting the adjacent worksurface runs straight for 3" before starting to curve.
- Support hardware must be ordered separately. See the listing in this section.

	DESCRIPTION	PRODUCT CODE	LIST PRICE			DIMENSIONS/INCHES	
			TF	HP	HPW	D	W
	Quarter Round Panel Corner Worksurface	EVWQRC1818	127	168	252	18	18
		EVWQRC2424	183	241	363	24	24
		EVWQRC3030	226	299	448	30	30

## EVWR - RADIUS WORKSURFACE

- Support hardware must be ordered separately. See listing in this section of the price book.
- Monoleg is included.
- Notched end is not finished.
- 18" and 24" come with one monoleg.
- 30" comes with two monolegs.

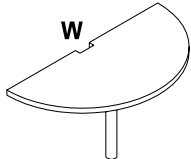
	DESCRIPTION	PRODUCT CODE	LIST PRICE			DIMENSIONS/INCHES	
			TF	HP	HPW	D	W
	Radius Worksurface	EVWR18	315	437	655	18	39
		EVWR24	365	507	761	24	51
		EVWR30	657	911	1366	30	63

## EVWKLL - "L" KEYBOARD WORKSURFACE

- Creates wrap around keyboard worksurface.
- For use with flat screen monitor.
- Note: Keyboard mechanism and tray must be specified separately.
- Use 12" cantilever supports on shorter 13" depth
- Support hardware must be order separately. See the listing in the section.

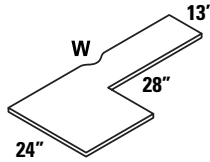
	DESCRIPTION	PRODUCT CODE	LIST PRICE		DIMENSIONS/INCHES	
			LP	HP	D	W
	"L" Keyboard Worksurface - Left	EVWKLL3624	170	226	24	36
		EVWKLL4224	198	263	24	42
		EVWKLL4824	227	302	24	48
	"L" Keyboard Worksurface - Right	EVWKLR3624	170	226	24	36
		EVWKLR4224	198	263	24	42
		EVWKLR4824	227	302	24	48

Right shown



# WORKSURFACES

## EVWIR - "T" ISLAND WORKSURFACE

- Creates efficient two person workstation when combined with "L" Keyboard Worksurface.
- Support hardware must be order separately. See the listing in the section.

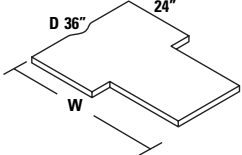
	DESCRIPTION	PRODUCT CODE	LIST PRICE		DIMENSIONS/INCHES	
			LP	HP	D	W
	"T" Island Worksurface	EWWIR244236	396	527	36	42
		EWWIR244836	453	602	36	48

## EVWSAC - ARC FRONT WORKSURFACE

- Use 12" cantilever supports on shorter 13" depth
- Support hardware must be order separately. See the listing in the section.

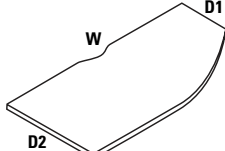
	DESCRIPTION	PRODUCT CODE	LIST PRICE		DIMENSIONS/INCHES		
			LP	HP	D1	D2	W
	Arc Front Worksurface - Left	EVWSAC122430	165	323	12	24	30
		EVWSAC122436	195	277	12	24	36
		EVWSAC122442	228	328	12	24	42
		EVWSAC122448	261	369	12	24	48
		EVWSAC122454	294	414	12	24	54
		EVWSAC122460	321	461	12	24	60
Left shown	Arc Front Worksurface - Right	EVWSAC241230	165	232	12	24	30
		EVWSAC241236	195	277	12	24	36
		EVWSAC241242	228	328	12	24	42
		EVWSAC241248	261	369	12	24	48
		EVWSAC241254	294	414	12	24	54
		EVWSAC241260	321	461	12	24	60

## EVWKE - EXTENDED CORNER WORKSURFACE

- Creates efficient two person workstation when combined with "L" Keyboard Worksurface.
- Support hardware must be order separately. See the listing in the section.

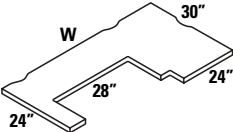
	DESCRIPTION	PRODUCT CODE	LIST PRICE		DIMENSIONS/INCHES	
			LP	HP	D	W
	Extended Corner Worksurface - Right	EVWKE663024	572	757	30	66
		EVWKE723024	624	827	30	72
		EVWKE783024	675	896	30	78
Left shown	Extended Corner Worksurface - Left	EVWKE306624	572	757	30	66
		EVWKE307224	624	827	30	72
		EVWKE307824	675	896	30	78



# WORKSURFACES

## EVWKKR - ANGLE FRONT EDGE WORKSURFACE

- To be used with EVWCF3012 and EVWCF3612 Corner Worksurface.
- Creates an efficient, compact keyboard corner worksurface.
- Use 12" cantilever supports on shorter 12" depth
- For use with flat screen monitor.
- Support hardware must be order separately. See the listing in the section.

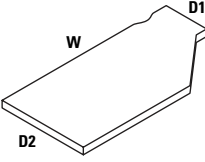
	DESCRIPTION	PRODUCT CODE	LIST PRICE		DIMENSIONS/INCHES		
			LP	HP	D1	D2	W
	Angle Front Edge Worksurface - Right	EVWKKR2436	170	226	12	24	36
		EVWKKR2442	198	263	12	24	42
		EVWKKR2448	227	302	12	24	48
	Angle Front Edge Worksurface - Left	EVWKKL2436	170	226	12	24	36
		EVWKKL2442	198	263	12	24	42
		EVWKKL2448	227	302	12	24	48

Left shown

## EVWT - STRAIGHT TRANSACTION WORKSURFACE

- Support hardware must be ordered separately. See listing in this section of the price book.

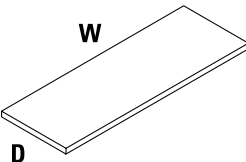
	DESCRIPTION	PRODUCT CODE	TF	LIST PRICE		DIMENSIONS/INCHES	
				HP	HPW	D	W
	Straight Transaction Worksurface	EVWT1512	43	61	91	15	12
		EVWT1518	57	78	116	15	18
		EVWT1524	68	95	143	15	24
		EVWT1530	82	112	169	15	30
		EVWT1536	93	129	194	15	36
		EVWT1542	106	147	220	15	42
		EVWT1548	120	164	245	15	48
		EVWT1554	130	180	272	15	54
		EVWT1560	145	199	299	15	60
		EVWT1566	156	217	327	15	66
		EVWT1572	169	234	350	15	72
		EVWT1578	182	250	375	15	78
		EVWT1584	193	268	403	15	84

## EVWTV - STRAIGHT TRANSACTION WORKSURFACE WITH CUT-OUT

- Used when mounted to a panel that has a taller panel against it in a straight run at an inline.
- Support hardware must be ordered separately. See listing in this section of the price book.

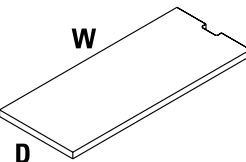
	DESCRIPTION	PRODUCT CODE	TF	LIST PRICE		DIMENSIONS/INCHES	
				HP	HPW	W	D
	Straight Transaction Worksurface with Cut-Out	EVWTV1524	78	102	152	15	24
		EVWTV1530	88	121	180	15	30
		EVWTV1536	101	136	204	15	36
		EVWTV1542	114	155	233	15	42
		EVWTV1548	127	173	260	15	48
		EVWTV1554	139	188	282	15	54
		EVWTV1560	151	201	302	15	60
		EVWTV1566	166	236	353	15	66
		EVWTV1572	175	241	363	15	72



# WORKSURFACES

## EVWTCL - "L" CORNER TRANSACTION SURFACE

- When specifying this item along with a straight surface, deduct 12" from each return side.
- Support hardware must be ordered separately. See listing in this section of the price book.

DESCRIPTION	PRODUCT CODE	LIST PRICE			DIMENSIONS/INCHES	
		TF	HP	HPW	D	W

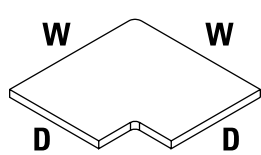

"L" Corner Transaction Surface	EVWTCL90	128	170	255	15	21
--------------------------------	----------	-----	-----	-----	----	----

## EVWTCT - "T" CORNER TRANSACTION SURFACE

- When specifying this item along with a straight surface, deduct 12" from each return side.
- Support hardware must be ordered separately. See listing in this section of the price book.

DESCRIPTION	PRODUCT CODE	LIST PRICE			DIMENSIONS/INCHES	
		TF	HP	HPW	D	W

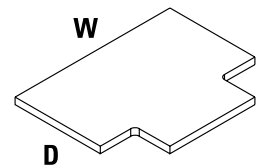

"T" Corner Transaction Surface	EVWTCT90	113	155	233	15	27
--------------------------------	----------	-----	-----	-----	----	----

## EVWTE - END TRANSACTION SURFACE

- Extends 1" past end of run.
- Support hardware must be ordered separately. See listing in this section of the price book.

DESCRIPTION	PRODUCT CODE	LIST PRICE			DIMENSIONS/INCHES	
		TF	HP	HPW	D	W

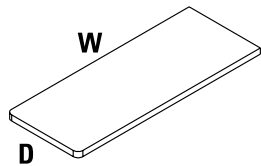

End Transaction Surface	EVWTE1512	57	78	116	15	14
	EVWTE1518	68	95	143	15	20
	EVWTE1524	82	112	169	15	26
	EVWTE1530	93	129	194	15	32
	EVWTE1536	106	147	220	15	38
	EVWTE1542	120	164	245	15	44
	EVWTE1548	130	180	272	15	50
	EVWTE1554	145	199	299	15	56
	EVWTE1560	156	217	327	15	62
	EVWTE1566	169	234	350	15	68
	EVWTE1572	182	250	375	15	74

## EVWTEV - END TRANSACTION SURFACE WITH CUT-OUT

- Used when mounted to a panel that has a taller panel against it in a straight run at an inline.
- Support hardware must be ordered separately. See listing in this section of the price book.
- Notched end is not finished.
- Extends 1" past end of run.

DESCRIPTION	PRODUCT CODE	LIST PRICE			DIMENSIONS/INCHES	
		TF	HP	HPW	D	W

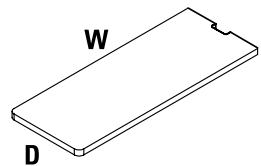

End Transaction Surface with Cut-Out	EVWTEV1524	88	121	180	15	26
	EVWTEV1530	101	136	204	15	32
	EVWTEV1536	114	155	233	15	38
	EVWTEV1542	127	173	260	15	44
	EVWTEV1548	139	188	282	15	50
	EVWTEV1554	151	208	311	15	56
	EVWTEV1560	166	224	337	15	62
	EVWTEV1566	175	242	364	15	68
	EVWTEV1572	189	260	389	15	74

# WORKSURFACES

## EVWTD - "D" TRANSACTION SURFACE

- Support hardware must be ordered separately. See listing in this section of the price book.

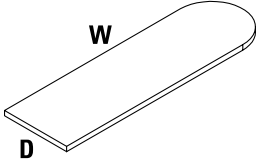
	DESCRIPTION	PRODUCT CODE	LIST PRICE			DIMENSIONS/INCHES	
			TF	HP	HPW	D	W
	"D" Transaction Surface	EVWTD1530	105	144	216	15	37
		EVWTD1536	113	156	234	15	43
		EVWTD1542	125	173	260	15	49
		EVWTD1548	139	190	284	15	55
		EVWTD1554	150	209	314	15	61
		EVWTD1560	166	228	341	15	67
		EVWTD1566	176	245	369	15	73
		EVWTD1572	192	267	402	15	79

## EVWTDV - END "D" TRANSACTION SURFACE WITH CUT-OUT

- Notched end is not finished.
- Used when mounted to a panel that has a taller panel against it in a straight run at an inline.
- Support hardware must be ordered separately. See listing in this section of the price book.

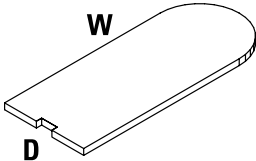
	DESCRIPTION	PRODUCT CODE	LIST PRICE			DIMENSIONS/INCHES	
			TF	HP	HPW	D	W
	End "D" Transaction Surface with Cut-Out	EVWTDV1530	113	151	228	15	37
		EVWTDV1536	120	163	243	15	43
		EVWTDV1542	132	179	269	15	49
		EVWTDV1548	146	198	298	15	55
		EVWTDV1554	156	214	321	15	61
		EVWTDV1560	171	235	352	15	67

## EVWTD - DOUBLE "D" TRANSACTION SURFACE

- Support hardware must be ordered separately. See listing in this section of the price book.

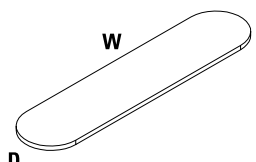
	DESCRIPTION	PRODUCT CODE	LIST PRICE			DIMENSIONS/INCHES	
			TF	HP	HPW	D	W
	Double "D" Transaction Surface	EVWTD1548	156	217	327	15	48
		EVWTD1560	182	250	375	15	60
		EVWTD1572	211	293	438	15	72

## EVW4T - CORNER TRANSACTION SURFACE FOR 45° POST

- Support hardware must be ordered separately. See listing in this section of the price book.

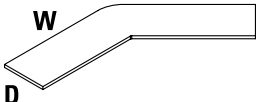
	DESCRIPTION	PRODUCT CODE	LIST PRICE			DIMENSIONS/INCHES	
			TF	HP	HPW	W	D
	Corner Transaction Surface for 45° Post	EVW4T1524	438	563	846	15	24
		EVW4T1530	547	705	1057	15	30
		EVW4T1536	765	986	1478	15	36
		EVW4T1542	1021	1314	1971	15	42
		EVW4T1548	1094	1408	2113	15	48



# WORKSURFACES

## EVW6T - CORNER TRANSACTION SURFACE FOR 60° POST

- Support hardware must be ordered separately. See listing in this section of the price book.

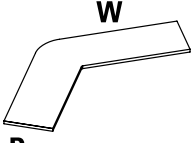
	DESCRIPTION	PRODUCT CODE	LIST PRICE			DIMENSIONS/INCHES	
			TF	HP	HPW	D	W
	Corner Transaction Surface for 60° Post	EVW6T1518	255	338	506	15	18
		EVW6T1524	401	535	801	15	24
		EVW6T1530	523	697	1046	15	30
		EVW6T1536	727	970	1455	15	36
		EVW6T1542	792	1057	1585	15	42
		EVW6T1548	1036	1383	2075	15	48

## EVW9T - CORNER TRANSACTION SURFACE FOR 90° POST

- Support hardware must be ordered separately. See listing in this section of the price book.

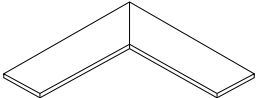
	DESCRIPTION	PRODUCT CODE	LIST PRICE			DIMENSIONS/INCHES	
			TF	HP	HPW	D	W
	Corner Transaction Surface for 90° Post - Left	EVW9TL1524	249	379	569	15	24
		EVW9TL1530	299	458	687	15	30
		EVW9TL1536	349	530	795	15	36
		EVW9TL1542	399	606	909	15	42
		EVW9TL1548	449	682	1023	15	48
	Corner Transaction Surface for 90° Post - Right	EVW9TR1524	249	379	569	15	24
		EVW9TR1530	299	458	687	15	30
		EVW9TR1536	349	530	795	15	36
		EVW9TR1542	399	606	909	15	42
		EVW9TR1548	449	682	1023	15	48

## EVWMP - WORKSURFACE MODESTY PANEL

- Modesty panel fastens to the worksurface and monoleg to provide additional privacy and support
  - Made of cold rolled steel
  - Metal finish is durable epoxy powder coated.

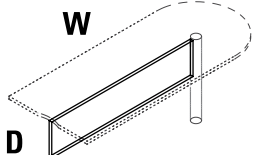
	DESCRIPTION	PRODUCT CODE	LIST PRICE		DIMENSIONS/INCHES	
					D	W
	Worksurface Modesty Panel	EVWMP1242	84		12	26
		EVWMP1248	94		12	32
		EVWMP1260	100		12	44
		EVWMP1272	113		12	56

## EVHEP - END PANEL

- Supports the worksurface and enhances the stability of connected panels.
  - Includes flat brackets and hardware.
- Provides solid support at the end of a run of worksurfaces.
  - End panel height is inclusive of panel glides extended to their fullest height.
- Finished in thermally-fused laminate.
  - If wood grains is selected, grain runs vertically.

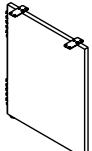
	DESCRIPTION	PRODUCT CODE	LIST PRICE		DIMENSIONS/INCHES	
					D	H
	End Panel - 29" High	EVHEP2918	127		18	28
		EVHEP2924	187		24	28
		EVHEP2930	219		30	28

# WORKSURFACES

## EVTHLEG - EVOLVE BRIDGES LEG

- Leg assembly attaches to panel for application which requires functionality of panels with environment of bridges tables.
- One leg with horizontal member connection to 1" increment slots in connector. Provides support to panel and panel connected worksurface at end of run- design coordinated with Bridges freestanding tables.
- Supports 24" and 30" deep worksurface
- One leg can support 2 adjoining worksurfaces by specifying 2 flat brackets.
- Leveling glides is standard
- No worksurface supporting beams, use panel cantilever and storage for worksurface support.
- One aluminum leg with steel structure - specify left or right and 24" or 30" deep for corresponding worksurface depth.
- Panel bracket, dislodgment clip and worksurface hardware included.
- Anodized aluminum upcharge \$32.00.
- Please specify paint finish.

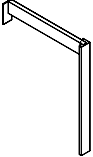
	DESCRIPTION	PRODUCT CODE	LIST PRICE	DIMENSIONS/INCHES		
				H	D	W
	Evolve Bridges Leg	EVTHLEG24LL	294	29	2.5	24
		EVTHLEG24RL	294	29	2.5	24
		EVTHLEG30LL	294	29	2.5	30
		EVTHLEG30RL	294	29	2.5	30

## EVHPL - EVOLVE PRINCETON LEG

- Princeton leg supports Evolve worksurfaces
- Includes leveling glides
- Available in standard paint finishes

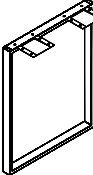
	DESCRIPTION	PRODUCT CODE	LIST PRICE	DIMENSIONS/INCHES		
				H	D	W
	Evolve Princeton Leg	EVHPL24	280	27.5	6.75	24
		EVHPL30	290	27.5	6.75	30

## EVHMEGR - METAL END GABLE - RIGHT

- Supports the worksurface and enhances the stability of connected panels.
- Includes a levelling glide and decorative PVC sleeve to cover the glide.
- Available in standard paint colors.

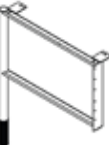
	DESCRIPTION	PRODUCT CODE	LIST PRICE	DIMENSIONS/INCHES		
				H	D	W
	Metal End Gable - Right	EVHMEG18R	184	28	17	4
		EVHMEG24R	195	28	23	4
		EVHMEG30R	206	28	29	4



# WORKSURFACES

## EVHMEGL - METAL END GABLE - LEFT

- Supports the worksurface and enhances the stability of connected panels.
- Includes a levelling glide and decorative PVC sleeve to cover the glide.
- Available in standard paint colors.

	DESCRIPTION	PRODUCT CODE	LIST PRICE	DIMENSIONS/INCHES		
				H	W	D
	Metal End Gable - Left	EVHMEG18L	184	28	17	4
		EVHMEG24L	195	28	23	4
		EVHMEG30L	206	28	29	4

## EVHMSL - METAL SUPPORT LEG

- Supports two adjoining worksurfaces and enhances the stability of connected panels.
- Includes a levelling glide and decorative PVC sleeve to cover the glide.
- Flat brackets recommended to ensure alignment of neighboring surface.
- Available in standard paint colors.
- Not designed for use at the end of a worksurface.
- Handedness of support leg cannot be changed.
- Not designed to be used with radius worksurfaces.

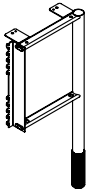
	DESCRIPTION	PRODUCT CODE	LIST PRICE	DIMENSIONS/INCHES		
				H	W	D
	Metal Support Leg	EVHMSL12	163	28	11	4

## EVHC - CANTILEVER FOR KEYBOARD WORKSURFACES

- Attaches a worksurface to a panel connector.
- Used to support two convergent worksurfaces.
- 2 flat brackets are included.
- Priced individually
- Specify handedness of each cantilever
- Available in standard paint colors.

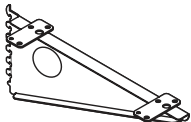
	DESCRIPTION	PRODUCT CODE	LIST PRICE	DIMENSIONS/INCHES	
				D	W
	Cantilever for Keyboard Worksurfaces	EVHC12L/R	72	12	6
		EVHC18L/R	72	18	6
		EVHC24L/R	83	24	6

## EVHS - SUPPORT LEG

- Used in conjunction with a EVHC cantilever.
- Provides extra support where needed.
- Used to help support two convergent worksurfaces.
- Available in standard paint colors.

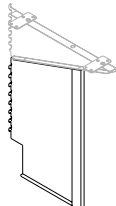
	DESCRIPTION	PRODUCT CODE	LIST PRICE	DIMENSIONS/INCHES		
				H	W	D
	Support Leg - Left	EVHSL2918	67	23.38	0.75	12.5
		EVHSL2924	67	23.38	0.75	12.5
	Support Leg - Right	EVHSR2918	67	23.38	0.75	12.5
		EVHSR2924	67	23.38	0.75	12.5

# WORKSURFACES

## EVHCL - CORNER LEG WITH LEVELER

- Provides support for a worksurface.
- Includes leveling glide, PVC Sleeve and attachment plate.
- 1.5" diameter
- Available in standard paint colors.
- Legs can be used in the corner of a single worksurface or be rotated 45 degrees to support the corners of two worksurfaces.

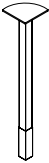
		DESCRIPTION	PRODUCT CODE	LIST PRICE	DIMENSIONS/INCHES H
 Round		Corner Leg Round	EVHCL1	87	28
	 Square	Corner Leg Square	EVHCL2	87	28

## EVHML - MONOLEG

- Provides support for a worksurface.
- Includes an adjustable foot and an attachment plate.
- 3" diameter.
- Available in standard paint colors.

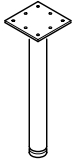
		DESCRIPTION	PRODUCT CODE	LIST PRICE	DIMENSIONS/INCHES H
		Monoleg	EVHML1	151	28

## EVHMSL - MID SUPPORT LEG

- Provides support for a worksurface.
- Includes leveling glide, PVC Sleeve and 4.8" x 4.8" attachment plate.
- 1.5" diameter.
- Available in standard paint colors.

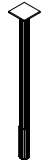
		DESCRIPTION	PRODUCT CODE	LIST PRICE	DIMENSIONS/INCHES H
		Mid Support Leg - Round	EVHMSL1	62	28
		Mid Support Leg - Square	EVHMSL2	62	28

## EVWS - 5" SURFACE TO STORAGE SUPPORT LEG

- Provides support for a worksurface.
- Includes leveling glide, PVC Sleeve and 4.8" x 4.8" attachment plate.
- 1.5" diameter.
- Available in standard paint colors.

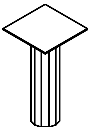
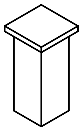
		DESCRIPTION	PRODUCT CODE	LIST PRICE	DIMENSIONS/INCHES H
 Round		5" Surface to Storage Support Leg - Round	EVWSRL01	37	4.5
 Square		5" Surface to Storage Support Leg - Square	EVWSSL01	37	4.5



### EVHCB - CORNER BRACKETS

- Attaches the corner of any worksurface to a panel connector.
- Priced and shipped in pairs.
- Available in standard paint colors.

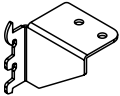
	DESCRIPTION	PRODUCT CODE	LIST PRICE	DIMENSIONS/INCHES	
				D	W
	Corner Brackets	EVHCB2	20	2.5	3.5

### EVHTB - TRANSACTION BRACKETS

- Securely attaches a transaction surface to the top of a panel.
- One pair must be on each side of transaction surface.
- Priced and shipped in pairs.
- Available in standard paint colors.

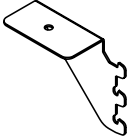
	DESCRIPTION	PRODUCT CODE	LIST PRICE	DIMENSIONS/INCHES	
				D	W
	Transaction Brackets	EVHTB2	20	2.5	3.5

### EVHFB - FLAT BRACKET

- Must be used in conjunction with cantilevers or transaction brackets to ensure alignment of neighboring surfaces.
- Priced individually
- Available in Black only.

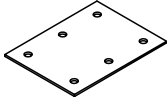
	DESCRIPTION	PRODUCT CODE	LIST PRICE	DIMENSIONS/INCHES	
				D	W
	Flat Bracket	EVHFB1	12	3	4

### EVHPB - PEDESTAL BRACKET

- Attaches to back edge of a pedestal and connects a pedestal to panel connector.
- Available in standard paint colors.

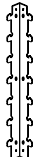
	DESCRIPTION	PRODUCT CODE	LIST PRICE	DIMENSIONS/INCHES	
				H	
	Pedestal Bracket	EVHPB1	23	11	



# NOTES

## EVHWSC - WORKSURFACE SUPPORT CHANNEL

- Support channel attaches to underside of worksurface with screws
- Support channel should be 14" shorter than top length.
- Screws are included.
- Only available in Black.
- Tops with post legs should be specified with support channel for structural reinforcement.

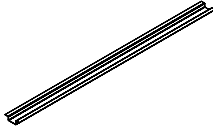
DESCRIPTION	PRODUCT CODE	LIST PRICE	DIMENSIONS/INCHES	
			L	D
 Worksurface Support Channel	EVHWSC40 - for 54" wide table	51	40	5
	EVHWSC46 - for 60" wide table	56	46	5
	EVHWSC52 - for 66" wide table	61	52	5
	EVHWSC58 - for 72" wide table	68	58	5
	EVHWSC64 - for 78" wide table	76	64	5
	EVHWSC70 - for 84" wide table	84	70	5

## EVHWCB1 - WORKSURFACE TO STORAGE BRACKETS

- Bracket connects Worksurface to Storage Towers and eStor as additional support.
- Bracket EVHWCB1 cannot fully support a Worksurface. It is to be used in conjunction with a Cantilever.
- Available in standard paint colors.

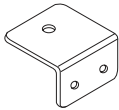
DESCRIPTION	PRODUCT CODE	LIST PRICE	DIMENSIONS/INCHES		
			H	D	W
 Worksurface to Storage Brackets	EVHWCB1	6	1.25	2	2

## EVHV - SINGLE SLOTTED WALL ADAPTER

- To attach system components to a fixed wall. The vertical wall adapter is a "U" shaped channel with a vertical row of 1" slots on center.
  - Mounting hardware not included. Mounting hardware selection to be based on wall material.
  - Use of wall rack requires lower tooth of top hook on cantilever or shelf to be notched in the field.
  - Available in standard paint colors.
  - Shipped & priced per pair.
- NOTE:**
- Care should be taken to mount adapters only to wall studs using correct fasteners. Failure to do this may result in collapse of the unit and subsequent possible personal injury.

DESCRIPTION	PRODUCT CODE	LIST PRICE	DIMENSIONS/INCHES	
			H	D
 Single Slotted Wall Track	EVHV01	61	60	.5

## EVSPD2015 - PENCIL DRAWER

- Accommodates writing instruments and small items at the workspace.
- Attaches to underside of a worksurface with drawer slides.
- Available in Black ABS plastic only.

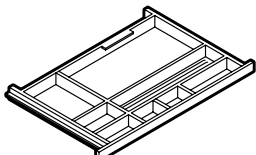
DESCRIPTION	PRODUCT CODE	LIST PRICE	DIMENSIONS/INCHES		
			H	D	W
 Pencil Drawer	EVSPD2015	127	1.5	22.5	17.75



freestanding

## EVD FSC - FIVE SIDED CORNER CHASSIS

- Five Sided Corner Chassis with 10" deep end panels for 18" & 24" deep tops and 14" end panels for 30" deep tops.
- Includes all supporting hardware. However a 2" "Z" bracket may be required depending on the adjacent connected unit (must be ordered separately).
- 1 7/16" high pressure worksurfaces cannot mount on chassis.
- All Freestanding products are available in thermally fused thickness only.

## NOTE:

- Add either "H" (half modesty) fo "F" (full modesty) to the end of the product code (i.e. EVD FSC3618H).
- Worksurface must be ordered separately.

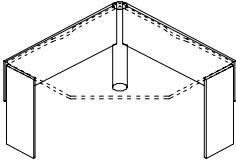
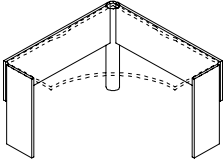
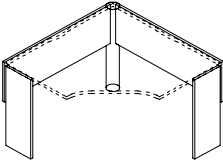
	DESCRIPTION	PRODUCT CODE	LIST PRICE		DIMENSIONS/INCHES		
			H	F	D	W	H
	Five Sided Corner Chassis - 36"	EVD FSC3618	596	773	18	36	29
		EVD FSC3624	596	773	24	36	29
	Five Sided Corner Chassis - 42"	EVD FSC4224	609	809	24	42	29
		EVD FSC4230	675	873	30	42	29
	Five Sided Corner Chassis - 48"	EVD FSC4824	639	866	24	48	29
		EVD FSC4830	705	929	30	48	29



**EVDRL - RETURN - LEFT**

- Return Chassis with one full end panel and modesty panel
- Includes all supporting hardware. However a 2" "Z" bracket may be required depending on the adjacent connected unit (must be ordered separately).
- 1 7/16" high pressure worksurfaces cannot mount on chassis.
- All Freestanding products are available in thermally fused thickness only.

**NOTE:**

- Add either "H" (half modesty) fo "F" (full modesty) to the end of the product code (i.e. EVDRL2436H).
- Worksurface must be ordered separately. Choose from Rectangular or Curved Surfaces.
- A "Z" Bracket (EVDHZ) is required where a modesty panel connects to an end panel (must be orderd separately).

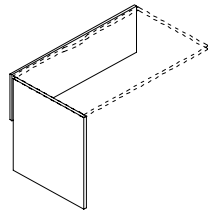

DESCRIPTION	PRODUCT CODE	LIST PRICE		DIMENSIONS/INCHES		
		H	F	D	W	H
Return - Left - 18"	EVDRL1824	249	317	18	24	29
	EVDRL1830	260	338	18	30	29
	EVDRL1836	273	361	18	36	29
	EVDRL1842	285	382	18	42	29
	EVDRL1848	327	434	18	48	29
	EVDRL1854	337	449	18	54	29
	EVDRL1860	354	484	18	60	29
	EVDRL1866	362	497	18	66	29
	EVDRL1872	379	524	18	72	29
Return - Left - 24"	EVDRL2424	256	325	24	24	29
	EVDRL2430	266	343	24	30	29
	EVDRL2436	281	368	24	36	29
	EVDRL2442	293	390	24	42	29
	EVDRL2448	333	440	24	48	29
	EVDRL2454	343	456	24	54	29
	EVDRL2460	362	492	24	60	29
	EVDRL2466	369	505	24	66	29
	EVDRL2472	386	533	24	72	29
Return - Left - 30"	EVDRL3024	279	344	30	24	29
	EVDRL3030	286	364	30	30	29
	EVDRL3036	302	302	30	36	29
	EVDRL3042	314	412	30	42	29
	EVDRL3048	353	460	30	48	29
	EVDRL3054	363	477	30	54	29
	EVDRL3060	381	514	30	60	29
	EVDRL3066	389	525	30	66	29
	EVDRL3072	408	553	30	72	29

**EVDRR - RETURN - RIGHT**

- Return Chassis with one full end panel and modesty panel
- Includes all supporting hardware. However a 2" "Z" bracket may be required depending on the adjacent connected unit (must be ordered separately).
- 1 7/16" high pressure worksurfaces cannot mount on chassis.
- All Freestanding products are available in thermally fused thickness only.

**NOTE:**

- Add either "H" (half modesty) fo "F" (full modesty) to the end of the product code (i.e. EVDRL2436H).
- Worksurface must be ordered separately. Choose from Rectangular or Curved Surfaces.
- A "Z" Bracket (EVDHZ) is required where a modesty panel connects to an end panel (must be ordered separately).

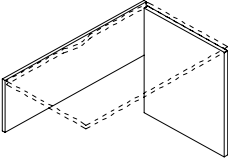
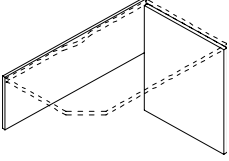
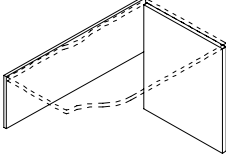
	DESCRIPTION	PRODUCT CODE	LIST PRICE		DIMENSIONS/INCHES		
			H	F	D	W	H
	Return - Right - 18"	EVDRR1824	249	317	18	24	29
		EVDRR1830	260	338	18	30	29
		EVDRR1836	273	361	18	36	29
		EVDRR1842	285	382	18	42	29
		EVDRR1848	327	434	18	48	29
		EVDRR1854	337	449	18	54	29
		EVDRR1860	354	484	18	60	29
		EVDRR1866	362	497	18	66	29
EVDRR1872	379	524	18	72	29		
	Return - Right - 24"	EVDRR2424	256	325	24	24	29
		EVDRR2430	266	343	24	30	29
		EVDRR2436	281	368	24	36	29
		EVDRR2442	293	390	24	42	29
		EVDRR2448	333	440	24	48	29
		EVDRR2454	343	456	24	54	29
		EVDRR2460	362	492	24	60	29
		EVDRR2466	369	505	24	66	29
EVDRR2472	386	533	24	72	29		
	Return - Right - 30"	EVDRR3024	279	344	30	24	29
		EVDRR3030	286	364	30	30	29
		EVDRR3036	302	389	30	36	29
		EVDRR3042	314	412	30	42	29
		EVDRR3048	353	460	30	48	29
		EVDRR3054	363	477	30	54	29
		EVDRR3060	381	514	30	60	29
		EVDRR3066	389	525	30	66	29
EVDRR3072	408	553	30	72	29		



## EVDB - BRIDGE CHASSIS - MODESTY

- Bridge Chassis includes modesty panel
- Add either "H" (half modesty) or "F" (full modesty to the end of the product code. (i.e. EVDB24H)
- Worksurface must be ordered separately. Choose from Rectangular or Curved Surfaces.
- Includes all supporting hardware including interconnection plates.
- A "Z" bracket (EVDHZ) is required where a modesty panel connects to an end panel (must be ordered separately).
- 1 7/16" high pressure worksurfaces cannot mount on chassis.
- All Freestanding products are available in thermally fused thickness only.

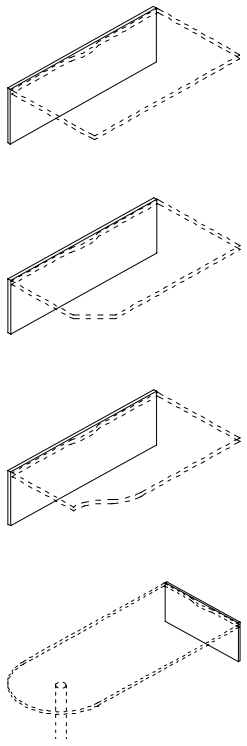
DESCRIPTION	PRODUCT CODE	LIST PRICE		DIMENSIONS/INCHES		
		H	F	D	W	H
	EVDB24	88	181	14/28	24	29
	EVDB30	96	192	14/28	30	29
	EVDB36	106	203	14/28	36	29
	EVDB42	124	233	14/28	42	29
	EVDB48	168	288	14/28	48	29
	EVDB54	187	322	14/28	54	29
	EVDB60	200	350	14/28	60	29
	EVDB66	221	382	14/28	66	29
EVDB72	234	412	14/28	72	29	

**EVDSRL - SUPPORTED RETURN - LEFT**

- Supported Return Chassis with full end panel, mid support panel modesty panel
- Add either "H" (half modesty) or "F" (full modesty to the end of the product code. (i.e. EVDSRL2436H)
- Worksurface must be ordered separately. Choose from Rectangular or Curved Surfaces.
- Includes 10" mid support panel where worksurface is 24" deep or for "D" top applications
- Includes 14" mid support panel where work surface is 30" deep
- Includes all supporting hardware. However a 2" "Z" bracket may be required depending on the adjacent connected unit (must be ordered separately).
- A "Z" Bracket (EVDHZ) is required where a modesty panel connects to an end panel (must be ordered separately).
- 1 7/16" high pressure worksurfaces cannot mount on chassis.
- All Freestanding products are available in thermally fused thickness only.

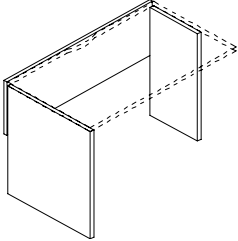
DESCRIPTION	PRODUCT CODE	LIST PRICE		DIMENSIONS/INCHES			
		H	F	D	W	H	
	Supported Return - Left - 24"	EVDSRL2424	361	426	24	24	29
	EVDSRL2430	371	447	24	30	29	
	EVDSRL2436	382	471	24	36	29	
	EVDSRL2442	396	494	24	42	29	
	EVDSRL2448	436	543	24	48	29	
	EVDSRL2454	446	560	24	54	29	
	EVDSRL2460	466	595	24	60	29	
	EVDSRL2466	471	609	24	66	29	
	EVDSRL2472	489	633	24	72	29	
Supported Return - Left - 30"	EVDSRL3024	413	481	24	24	29	
	EVDSRL3030	423	500	24	30	29	
	EVDSRL3036	436	522	24	36	29	
	EVDSRL3042	449	545	24	42	29	
	EVDSRL3048	489	596	24	48	29	
	EVDSRL3054	499	612	24	54	29	
	EVDSRL3060	518	648	24	60	29	
	EVDSRL3066	524	595	24	66	29	
	EVDSRL3072	541	688	24	72	29	



## EVDSRR - SUPPORTED RETURN - RIGHT

- Supported Return Chassis with full end panel, mid support panel modesty panel
- Add either "H" (half modesty) of "F" (full modesty to the end of the product code. (i.e. EVDSRL2436H)
- Worksurface must be ordered separately. Choose from Rectangular or Curved Surfaces.
- Includes 10" mid support panel where worksurface is 24" deep or for "D" top applications
- Includes 14" mid support panel where work surface is 30" deep
- Includes all supporting hardware. However a 2" "Z" bracket may be required depending on the adjacent connected unit (must be ordered separately).
- A "Z" Bracket (EVDHZ) is required where a modesty panel connects to an end panel (must be ordered separately).
- 1 7/16" high pressure worksurfaces cannot mount on chassis
- All Freestanding products are available in thermally fused thickness only.

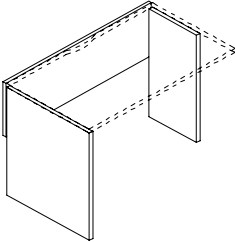
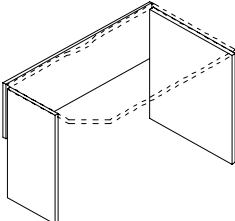
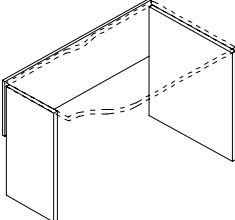
	DESCRIPTION	PRODUCT CODE	LIST PRICE		DIMENSIONS/INCHES		
			H	F	D	W	H
	Supported Return - Right - 24"	EVDSRR2424	361	426	24	24	29
		EVDSRR2430	371	447	24	30	29
		EVDSRR2436	382	471	24	36	29
		EVDSRR2442	396	494	24	42	29
		EVDSRR2448	436	543	24	48	29
		EVDSRR2454	446	560	24	54	29
		EVDSRR2460	466	595	24	60	29
		EVDSRR2466	471	609	24	66	29
	EVDSRR2472	489	633	24	72	29	
	Supported Return - Right - 30"	EVDSRR3024	413	481	30	24	29
		EVDSRR3030	423	500	30	30	29
		EVDSRR3036	436	522	30	36	29
		EVDSRR3042	449	545	30	42	29
		EVDSRR3048	489	596	30	48	29
		EVDSRR3054	499	612	30	54	29
		EVDSRR3060	518	648	30	60	29
		EVDSRR3066	524	595	30	66	29
		EVDSRR3072	541	688	30	72	29
							



**EVDSB - SUPPORTED BRIDGE CHASSIS**

- Supported Bridge Chassis with two mid support panels and modesty panel
- Add either "H" (half modesty) or "F" (full modesty to the end of the product code. (i.e. EVDSB2436H)
- Worksurface must be ordered separately. Choose from Rectangular or Curved Surfaces.
- Note: Includes 10" mid support panel where worksurface is 24" deep or for "D" top applications
- Includes 14" mid support panel where work surface is 30" deep
- Includes all supporting hardware. However a 2" "Z" bracket may be required depending on the adjacent connected unit (must be ordered separately).
- A "Z" Bracket (EVDHZ) is required where a modesty panel connects to an end panel (must be ordered separately).
- 1 7/16" high pressure worksurfaces cannot mount on chassis.
- All Freestanding products are available in thermally fused thickness only.

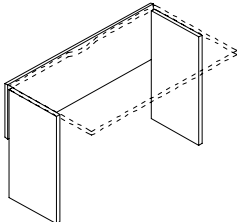
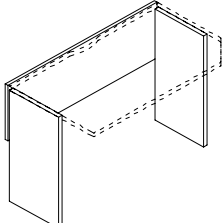
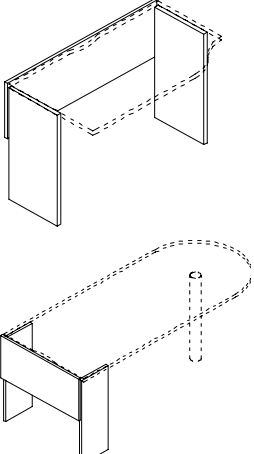
	DESCRIPTION	PRODUCT CODE	LIST PRICE		DIMENSIONS/INCHES				
			H	F	D	W	H		
	Supported Bridge Chassis - 24"	EVDSB2424	281	350	10	24	29		
		EVDSB2430	289	371	10	30	29		
		EVDSB2436	304	394	10	36	29		
		EVDSB2442	316	418	10	42	29		
		EVDSB2448	355	469	10	48	29		
		EVDSB2454	366	484	10	54	29		
		EVDSB2460	384	520	10	60	29		
		EVDSB2466	391	536	10	66	29		
	Supported Bridge Chassis - 30"	EVDSB3024	346	415	14	24	29		
		EVDSB3030	355	436	14	30	29		
		EVDSB3036	369	460	14	36	29		
		EVDSB3042	381	483	14	42	29		
		EVDSB3048	422	534	14	48	29		
		EVDSB3054	430	552	14	54	29		
		EVDSB3060	449	586	14	60	29		
		EVDSB3066	456	600	14	66	29		
				EVDSB3072	473	627	14	72	29



## EVDUD - RECTANGULAR DESK CHASSIS

- Desk Chassis with full end panels and modesty panel
- Add either "H" (half modesty) or "F" (full modesty to the end of the product code. (i.e. EVDUD2436H)
- Worksurface must be ordered separately.
- Includes all supporting hardware. However a 2" "Z" bracket may be required depending on the adjacent connected unit (must be ordered separately).
- A "Z" Bracket (EVDHZ) is required where a modesty panel connects to an end panel (must be ordered separately).
- 1 7/16" high pressure worksurfaces cannot mount on chassis.
- All Freestanding products are available in thermally fused thickness only.

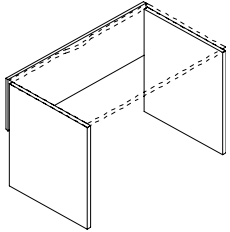
DESCRIPTION	PRODUCT CODE	LIST PRICE		DIMENSIONS/INCHES			
		H	F	D	W	H	
	Rectangular Desk Chassis - 18"	EVDUD1836	450	534	18	36	29
	EVDUD1842	466	556	18	42	29	
	EVDUD1848	504	607	18	48	29	
	EVDUD1854	515	624	18	54	29	
	EVDUD1860	533	656	18	60	29	
	EVDUD1866	540	668	18	66	29	
	EVDUD1872	556	696	18	72	29	
	EVDUD1878	568	720	18	78	29	
	EVDUD1884	577	736	18	84	29	
	Rectangular Desk Chassis - 24"	EVDUD2436	462	552	24	36	29
EVDUD2442		474	574	24	42	29	
EVDUD2448		516	624	24	48	29	
EVDUD2454		524	640	24	54	29	
EVDUD2460		543	674	24	60	29	
EVDUD2466		552	688	24	66	29	
EVDUD2472		568	714	24	72	29	
EVDUD2478		579	737	24	78	29	
Rectangular Desk Chassis - 30"	EVDUD2484	587	755	24	84	29	
	EVDUD3036	504	589	30	36	29	
	EVDUD3042	517	612	30	42	29	
	EVDUD3048	556	663	30	48	29	
	EVDUD3054	567	680	30	54	29	
	EVDUD3060	584	715	30	60	29	
	EVDUD3066	590	729	30	66	29	
	EVDUD3072	609	755	30	72	29	
	EVDUD3078	620	779	30	78	29	
	EVDUD3084	627	794	30	84	29	

**EVDECCL - EXTENDED CORNER CHASSIS - LEFT**

- Extended Corner Chassis with 10" or 14" deep end panel at (C) and full end panel at (D) and with half height modesty panels
- Add either "H" (half modesty) of "F" (full modesty to the end of the product code. (i.e. EVDECCL362448H)
- Worksurface must be ordered separately. Use 10" End Panels where work surface is 18" or 24" deep. Use 14" End Panels where work surface is 30" deep.
- Includes all supporting hardware. However a 2" "Z" bracket may be required depending on the adjacent connected unit (must be ordered separately).
- A "Z" Bracket (EVDHZ) is required where a modesty panel connects to an end panel (must be ordered separately).
- 1 7/16" high pressure worksurfaces cannot mount on chassis.
- All Freestanding products are available in thermally fused thickness only.

	DESCRIPTION	PRODUCT CODE	LIST PRICE		DIMENSIONS/INCHES		
			H	F	D	W	H
	Extended Corner Chassis - Left - 36"	EVDECCL362448	735	953	24	48	29
		EVDECCL362460	756	988	24	60	29
		EVDECCL362466	769	1015	24	66	29
		EVDECCL362472	790	1046	24	72	29
		EVDECCL362478	802	1073	24	78	29
	Extended Corner Chassis - Left - 42" x 24"	EVDECCL422460	773	1016	24	60	29
		EVDECCL422466	784	1042	24	66	29
		EVDECCL422472	802	1078	24	72	29
		EVDECCL422478	818	1105	24	78	29
		EVDECCL422484	831	1132	24	84	29
Extended Corner Chassis - Left - 42" x 30"	EVDECCL423060	870	1067	30	60	29	
	EVDECCL423066	926	1097	30	66	29	
	EVDECCL423072	961	1130	30	72	29	
	EVDECCL423078	989	1158	30	78	29	
	EVDECCL423084	1019	1185	30	84	29	
Extended Corner Chassis - Left - 48" x 30"	EVDECCL483060	916	1125	30	60	29	
	EVDECCL483066	971	1154	30	66	29	
	EVDECCL483072	1002	1188	30	72	29	
	EVDECCL483078	1033	1213	30	78	29	
	EVDECCL483084	1064	1239	30	84	29	



**EVDECCR - EXTENDED CORNER CHASSIS - RIGHT**

- Extended Corner Chassis with 10" or 14" deep end panel at (C) and full end panel at (D) and with half height modesty panels
- Add either "H" (half modesty) or "F" (full modesty to the end of the product code. (i.e. EVDECCCL362448H)
- Worksurface must be ordered separately. Use 10" End Panels where work surface is 18" or 24" deep. Use 14" End Panels where work surface is 30" deep.
- Includes all supporting hardware. However a 2" "Z" bracket may be required depending on the adjacent connected unit (must be ordered separately).
- A "Z" Bracket (EVDHZ) is required where a modesty panel connects to an end panel (must be ordered separately).
- 1 7/16" high pressure worksurfaces cannot mount on chassis.
- All Freestanding products are available in thermally fused thickness only.

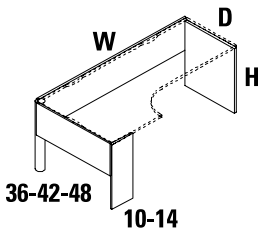
DESCRIPTION	PRODUCT CODE	LIST PRICE		DIMENSIONS/INCHES			
		H	F	D	W	H	
 <p>36-42-48 10-14</p>	Extended Corner Chassis - Right - 36"	EVDECCR362448	735	953	24	48	29
	EVDECCR362460	756	988	24	60	29	
	EVDECCR362466	769	1015	24	66	29	
	EVDECCR362472	790	1046	24	72	29	
	EVDECCR362478	802	1073	24	78	29	
	EVDECCR362484	816	1101	24	84	29	
	Extended Corner Chassis - Right - 42" x 24"	EVDECCR422460	773	1016	24	60	29
	EVDECCR422466	784	1042	24	66	29	
	EVDECCR422472	802	1078	24	72	29	
	EVDECCR422478	818	1105	24	78	29	
	EVDECCR422484	831	1132	24	84	29	
		Extended Corner Chassis - Right - 42" x 30"	EVDECCR423060	870	1067	30	60
EVDECCR423066		926	1097	30	66	29	
EVDECCR423072		961	1130	30	72	29	
EVDECCR423078		989	1158	30	78	29	
EVDECCR423084		1019	1185	30	84	29	
		Extended Corner Chassis - Right - 48" x 30"	EVDECCR483060	916	1125	30	60
	EVDECCR483066	971	1154	30	66	29	
	EVDECCR483072	1002	1188	30	72	29	
	EVDECCR483078	1033	1213	30	78	29	
	EVDECCR483084	1064	1239	30	84	29	

**EVDCCL - CONFERENCE TOP CHASSIS - LEFT**

- Conference Top Chassis is use to support Hatchet Tops, "D" Tops and similar worksurfaces that are also supported by mono legs. Incorporates 10" deep end panel at (C) and corner leg at (B) and modesty panel at (D)
- Add either "H" (half modesty) or "F" (full modesty to the end of the product code. (i.e. EVDCCL3024H)
- Note: Worksurface must be ordered separately. Mono Leg is included with Hatchet Top Worksurface
- Includes all supporting hardware.
- 1 7/16" high pressure worksurfaces cannot mount on chassis.
- All Freestanding products are available in thermally fused thickness only.

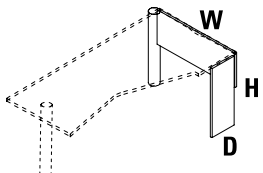
DESCRIPTION	PRODUCT CODE	LIST PRICE		DIMENSIONS/INCHES			
		H	F	D	W	H	
	Conference Top Chassis - Left	EVDCCL3024	362	452	24	30	29
	EVDCCL3624	375	471	24	36	29	
	Conference Top Chassis - Right	EVDCR3024	362	452	24	30	29
	EVDCR3624	375	471	24	36	29	

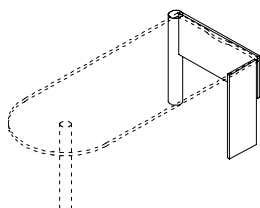

**EVDSHF - HUTCH - SINGLE DOOR**

- Desk Hutch with metal end panels, shelves and doors
- Full height back panel is thermally fused laminate
- Includes lock
- Ships Knocked Down.
- Includes all supporting hardware.
- All Freestanding products are available in thermally fused thickness only.

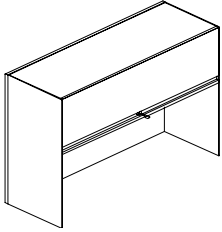
DESCRIPTION	PRODUCT CODE	LIST PRICE	DIMENSIONS/INCHES			
			H	D	W	H
 Hutch - Single Door	EVDSHF1336	839	13	36	36 3/4	
	EVDSHF1342	918	13	42	36 3/4	
	EVDSHF1348	973	13	48	36 3/4	
	EVDSHF1354	1031	13	54	36 3/4	
	EVDSHF1360	1084	13	60	36 3/4	

**EVDSHF - HUTCH - DOUBLE DOOR**

- Desk Hutch with metal end panels, shelves and doors
- Full height back panel is thermally fused laminate
- Includes lock
- Ships Knocked Down.
- Includes all supporting hardware
- All Freestanding products are available in thermally fused thickness only.

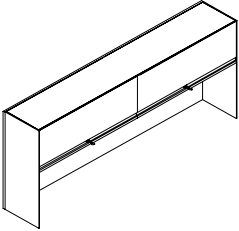
DESCRIPTION	PRODUCT CODE	LIST PRICE	DIMENSIONS/INCHES			
			H	D	W	H
 Hutch - Double Door	EVDSHF1372	1355	13	72	36 3/4	
	EVDSHF1378	1404	13	78	36 3/4	
	EVDSHF1384	1506	13	84	36 3/4	



**EVDTB - FREESTANDING TACK BOARD - HUTCH**

- Provides a tackable surface for notes and memos in work area.
- Includes two pairs of hutch mounted brackets.
- Fabric must be specified.

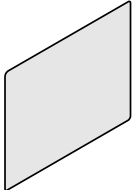
	DESCRIPTION	PRODUCT CODE	LIST PRICE		DIMENSIONS/INCHES	
			Gr1	Gr2	W	H
	Freestanding Tack Board - Hutch	EVDTB1836	219	225	36	17
		EVDTB1842	250	258	42	17
		EVDTB1848	280	289	48	17
		EVDTB1854	308	321	54	17
		EVDTB1860	339	351	60	17

**EVDTB - FREESTANDING DOUBLE TACK BOARD - HUTCH**

- Includes 2 separate tack boards that are mounted side-by-side to make up total length.
- Provides a tackable surface for notes and memos in work area.
- Includes mounting hardware.. However a 2" bracket may be required depending on the adjacent connected unit.
- Fabric must be specified.

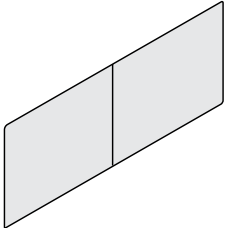
	DESCRIPTION	PRODUCT CODE	LIST PRICE		DIMENSIONS/INCHES	
			Gr1	Gr2	W	H
	Freestanding Double Tack Board - Hutch	EVDTB1872	437	448	72	17
		EVDTB1878	468	483	78	17
		EVDTB1884	497	517	84	17

**EVDTB18-H - HALF WIDTH - TACK BOARD - HUTCH**

- Tack Board is to be mounted on the back wall of the FS Hutch (EVDSHF13).
- Tack board may be used in conjunction with EVALB2-H.
- Designed to cover only half width of the back wall.
- Use EVDTB18 Tack Boards to cover the whole back of the FS Hutch.
- Provides a tackable surface for notes and memos in working area.
- Includes two pairs of hutch mounting brackets.
- Fabric must be specified.

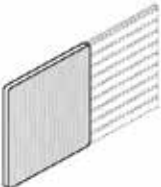
	DESCRIPTION	PRODUCT CODE	LIST PRICE		DIMENSIONS/INCHES	
			Gr1	Gr2	W	H
	Half Width - Tack Board - Hutch	EVDTB18-H18	180	184	17	18
		EVDTB18-H21	185	188	20	18
		EVDTB18-H24	188	194	23	18
		EVDTB18-H27	197	202	25	18
		EVDTB18-H30	204	211	29	18
		EVDTB18-H36	233	239	35	18
		EVDTB18-H39	247	259	38	18
		EVDTB18-H42	265	276	41	18

**EVALB2-H - HALF WIDTH - GANGING LOAD BAR - HUTCH**

- Ganging Load Bar is to be mounted on the back wall of the FS Hutch (EVDSHF13).
- To be used in conjunction with EVDTB18-H Tack Board.
- Load Bar enables accessory items to be hung off it.
- Priced per single load bar.
- 9 Ganging Load Bars will match EVDTB18-H full height.

DESCRIPTION	PRODUCT CODE	LIST PRICE	DIMENSIONS/INCHES	
			W	H
 Half Width - Ganging Load Bar - Hutch	EVALB2-H18	55	18	2 1/4
	EVALB2-H21	58	21	2 1/4
	EVALB2-H24	59	24	2 1/4
	EVALB2-H27	61	26	2 1/4
	EVALB2-H30	62	30	2 1/4
	EVALB2-H36	66	36	2 1/4
	EVALB2-H39	68	39	2 1/4
	EVALB2-H42	70	42	2 1/4

**EVALB2-4 - GANGING LOAD BAR - HUTCH**

- Load Bar is to be mounted on the back wall of the FS Hutch (EVDSHF13).
- Load Bar enables accessory items to be hung off it.
- Designed to cover the full width of the back wall of the FS Hutch (EVDSHF13).
- Do not use in conjunction with the Tack Boards.
- Priced per single load bar.

DESCRIPTION	PRODUCT CODE	LIST PRICE	DIMENSIONS/INCHES	
			W	H
 Ganging Load Bar - Hutch	EVALB2-436	88	36	2 1/4
	EVALB2-442	94	42	2 1/4
	EVALB2-448	100	48	2 1/4
	EVALB2-454	104	54	2 1/4
	EVALB2-460	107	60	2 1/4
	EVALB2-472	117	72	2 1/4
	EVALB2-478	123	78	2 1/4
	EVALB2-484	126	84	2 1/4

**EVDSHD01 - OVERHEAD DIVIDER - HUTCH**

- Attaches to overhead top shelf inside the FS Hutch.
- Provides rigid division for books and binders.

DESCRIPTION	PRODUCT CODE	LIST PRICE	DIMENSIONS/INCHES	
			W	H
Overhead Divider - Hutch	EVDSHD01	47	3/16	10

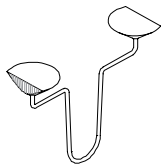

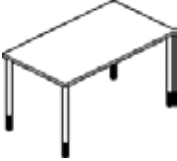
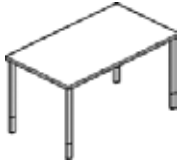

**EWWFR - RECTANGULAR FREESTANDING WORKSURFACE WITH CORNER LEGS**

- Worksurface include 6 threaded-metal inserts in corners, to allow for metal-to-metal connections.
- Worksurface is available in 1-1/16" thick High Pressure laminate only.
- Legs are 1.5" diameter and include leveling glide, PVC sleeve and attachment plate. PVC sleeve available in Evolve standard colors only.
- Legs can be used in the corner of a single worksurface, or rotated 45 degrees to support the corners of two worksurfaces.
- Ships Knocked Down.
- All Freestanding products are available in thermally fused thickness only.

	DESCRIPTION	PRODUCT CODE	LIST PRICE	DIMENSIONS/INCHES		
				D	W	H
	Rectangular Freestanding Worksurface with Round Corner Legs	EWWFR2448HP	598	24	48	29
		EWWFR2460HP	693	24	60	29
		EWWFR3048HP	650	30	48	29
		EWWFR3060HP	711	30	60	29
	Rectangular Freestanding Worksurface with Square Corner Legs	EWWFRS2448HP	598	24	48	29
		EWWFRS2460HP	693	24	60	29
		EWWFRS3048HP	650	30	48	29
		EWWFRS3060HP	711	30	60	29

**EWWFS - SQUARE FREESTANDING WORKSURFACE WITH CORNER LEGS**

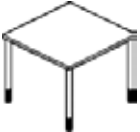

- Worksurface include 6 threaded-metal inserts in corners, to allow for metal-to-metal connections.
- Worksurface is available in 1-1/16" thick High Pressure laminate only.
- Legs are 1.5" diameter and include leveling glide, PVC sleeve and attachment plate. PVC sleeve available in Evolve standard colors only.
- Legs can be used in the corner of a single worksurface, or rotated 45 degrees to support the corners of two worksurfaces.
- Ships Knocked Down.
- All Freestanding products are available in thermally fused thickness only.

	DESCRIPTION	PRODUCT CODE	LIST PRICE	DIMENSIONS/INCHES		
				D	W	H
	Square Freestanding Worksurface with Round Corner Legs	EWWFS36HP	631	36	36	29
		EWWFS42HP	725	42	42	29
		EWWFS48HP	856	48	48	29
	Square Freestanding Worksurface with Square Corner Legs	EWWFSS36HP	631	36	36	29
		EWWFSS42HP	725	42	42	29
		EWWFSS48HP	856	48	48	29





**EVWFC - ROUND FREESTANDING WORKSURFACE WITH CORNER LEGS**

- Worksurface include 6 threaded-metal inserts in corners, to allow for metal-to-metal connections.
- Worksurface is available in 1-1/16" thick High Pressure laminate only.
- Legs are 1.5" diameter and include leveling glide, PVC sleeve and attachment plate.
- Legs can be used in the corner of a single worksurface, or rotated 45 degrees to support the corners of two worksurfaces.
- Ships Knocked Down.
- All Freestanding products are available in thermally fused thickness only.

	DESCRIPTION	PRODUCT CODE	LIST PRICE	DIMENSIONS/INCHES	
				W	H
	Round Freestanding Worksurface with Corner Legs	EWWFC36HP	673	36	29
		EWWFC42HP	810	42	29
		EWWFC48HP	968	48	29
	Round Freestanding Worksurface with Square Corner Legs	EWWFCS36HP	673	36	29
		EWWFCS42HP	810	42	29
		EWWFCS48HP	968	48	29

**EVWFD - PANEL MOUNTED WORKSURFACE WITH CORNER LEGS**

- "D" top table with 2 legs, panel mounted.
- Support hardware must be ordered separately. See the listings in this section.
- Worksurface include 6 threaded-metal inserts in corners, to allow for metal-to-metal connections.
- Worksurface is available in 1-1/16" thick High Pressure laminate only.
- Legs are 1.5" diameter and include leveling glide, PVC sleeve and attachment plate.
- Legs can be used in the corner of a single worksurface, or rotated 45 degrees to support the corners of two worksurfaces.
- Ships Knocked Down.
- All Freestanding products are available in thermally fused thickness only.

	DESCRIPTION	PRODUCT CODE	LIST PRICE	DIMENSIONS/INCHES		
				D	W	H
	Panel Mounted Worksurface with Corner Legs	EWWFD2448HP	488	24	48	29
		EWWFD2460HP	571	24	60	29
		EWWFD3048HP	584	30	48	29
		EWWFD3060HP	617	30	60	29
	Panel Mounted Worksurface with Square Corner Legs	EWWFDS2448HP	488	24	48	29
		EWWFDS2460HP	571	24	60	29
		EWWFDS3048HP	584	30	48	29
		EWWFDS3060HP	617	30	60	29



**EVHCL - CORNER LEG WITH LEVELER**

- Provides support for a work surface.
- Includes leveling glide, PVC Sleeve and attachment plate. PVC sleeve available in Evolve standard colors only.
- 1.5" diameter
- Available in standard paint colors.
- Legs can be used in the corner of a single work surface or be rotated 45 degrees to support the corners of two work surfaces.

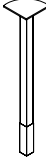
DESCRIPTION		PRODUCT CODE	LIST PRICE	DIMENSIONS/INCHES H
	Corner Leg Round	EVHCL1	87	28
	Corner Leg Square	EVHCL2	87	28

Round

Sqaure

**EVDMPCL - CORNER MODESTY PANEL - LEFT**

- Corner modesty panel connects to the corner leg on one side, and to inter connect panel/end panel on the other.
- Note: Add either "H" (half modesty) or "F" (full modesty to the end of the product code. (i.e. EVDMPCL36H)
- Includes all supporting hardware including interconnection plates. However a 2" "Z" bracket may be required depending on the adjacent connected unit (must be ordered separately).
- All Freestanding products are available in thermally fused thickness only.

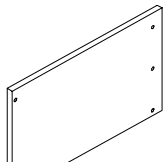
DESCRIPTION	PRODUCT CODE	LIST PRICE		DIMENSIONS/INCHES	
		H	F	W	H
	EVDMPCL36	106	203	36	14/28
	EVDMPCL42	124	233	42	14/28
	EVDMPCL48	168	288	48	14/28
	EVDMPCL54	187	322	54	14/28
	EVDMPCL60	200	350	60	14/28
	EVDMPCL66	221	382	66	14/28
	EVDMPCL72	234	412	72	14/28

Half Modesty

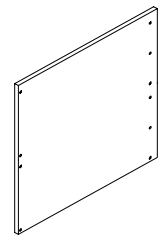

Full Modesty

**EVDMPCR - CORNER MODESTY PANEL - RIGHT**

- Corner modesty panel connects to the corner leg on one side, and to inter connect panel/end panel on the other.
- Note: Add either "H" (half modesty) or "F" (full modesty to the end of the product code. (i.e. EVDMPCL36H)
- Includes all supporting hardware including interconnection plates
- All Freestanding products are available in thermally fused thickness only.

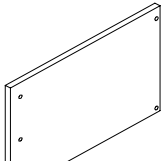
DESCRIPTION	PRODUCT CODE	LIST PRICE		DIMENSIONS/INCHES		
		H	F	W	H	
	Corner Modesty Panel - Right	EVDMPCR36	106	203	36	14/28
		EVDMPCR42	124	233	42	14/28
		EVDMPCR48	168	288	48	14/28
		EVDMPCR54	187	322	54	14/28
		EVDMPCR60	200	350	60	14/28
		EVDMPCR66	221	382	66	14/28
	EVDMPCR72	234	412	72	14/28	

Half Modesty

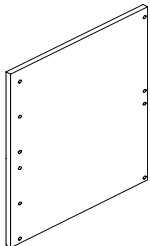

Full Modesty

**EVDEP - END PANEL**

- Supports worksurface
- Includes two end panel brackets, and two levelling glides
- Must be ordered left or right
- End panel height is inclusive of panel glides extended to their fullest height.
- All Freestanding products are available in thermally fused thickness only.

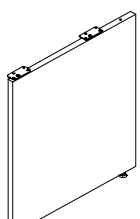
DESCRIPTION	PRODUCT CODE	LIST PRICE		DIMENSIONS/INCHES		
		H	F	W	H	
	End Panel - Left	EVDEPL2924	198		24	28
		EVDEPL2930	218		30	28
		EVDEPL2624	177		24	28
		EVDEPL2630	207		30	28
End Panel - Right		EVDEPR2924	198		24	28
		EVDEPR2930	218		30	28
		EVDEPR2624	177		24	28
		EVDEPR2630	207		30	28



**EVDCP - CENTRAL SUPPORT PANEL**

- Supports and connects 2 worksurfaces
- Includes two end panel brackets, two levelling glides and modesty inter connect bracket (EVDECCR)
- Attaches to modesty panel
- End panel height is inclusive of panel glides extended to their fullest height
- All Freestanding products are available in thermally fused thickness only.

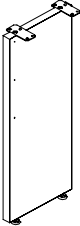
	DESCRIPTION	PRODUCT CODE	LIST PRICE H	DIMENSIONS/INCHES	
				W	H
	Central Support Panel	EVDCP2910	119	10	28
		EVDCP2914	151	14	28
		EVDCP2610	106	10	28
		EVDCP2614	142	14	28

**EVDHMSB - MID SUPPORT BRACKET**

- Provides mid support for worksurfaces
- Recommended for any lengths over 42"

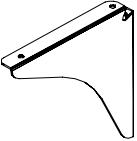
	DESCRIPTION	PRODUCT CODE	LIST PRICE	DIMENSIONS/INCHES		
				D	W	H
	Mid Support Bracket	EVDHMSB	35	7 1/2	7 1/2	1/2

**EVDHZ - "Z" BRACKET**

- Attaches modesty panel to front edge of end panel
- To be used when a return is attached to a rectangular desk
- Available in black only

	DESCRIPTION	PRODUCT CODE	LIST PRICE	DIMENSIONS/INCHES		
				D	W	H
	"Z" Bracket	EVDHZ	19	1	12 1/2	1/2

**EVHFB1 - FLAT BRACKET**

- Must be used in conjunction with Mid panels to ensure alignment of neighboring surfaces
- Three flat brackets must be used to support a return worksurface

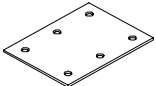
	DESCRIPTION	PRODUCT CODE	LIST PRICE	DIMENSIONS/INCHES	
				D	W
	Flat Bracket	EVHFB1	12	5	3

**EVDHSP1 - SCREW PACK**

- 3 screws #10 x 5/8" for Pedestal to Modesty Panel connection

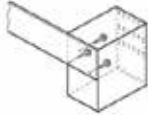
	DESCRIPTION	PRODUCT CODE	LIST PRICE	DIMENSIONS/INCHES	
				W	
	Screw Pack	EVDHSP1	8	5/8	

**EVDECCR - MODESTY INTER-CONNECT BRACKET**

- Attaches two modesty panels to a mid support panel

	DESCRIPTION	PRODUCT CODE	LIST PRICE	DIMENSIONS/INCHES	
				W	H
	Modesty Inter-Connect Bracket	EVDECCR	19	12 1/2	4

**EVDHPMPR - PANEL MOUNT BRACKET**

- Attaches modesty panel to and Evolve Inline Connector

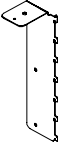
	DESCRIPTION	PRODUCT CODE	LIST PRICE	DIMENSIONS/INCHES		
				D	W	H
	Panel Mount Bracket - Right	EVDHPMPR	24	3	13	3 1/2
	Panel Mount Bracket - Left	EVDHPMPL	24	3	13	3 1/2

**EVDHLB - END PANEL "L" BRACKET**

- Attaches a modesty panel to an end panel

	DESCRIPTION	PRODUCT CODE	LIST PRICE	DIMENSIONS/INCHES		
				D	W	H
	End Panel "L" Bracket	EVDHLB	20	1 1/2	12	1 1/2



storage

## LATERAL FILE FEATURES

### LATERAL FILES

- Binder storage
- EDP storage (with optional EDP sides)
- Lifetime Warranty (see Terms & Conditions)
- Counterweights must be specified on lateral files with pull out drawers, unless worksurface supporting, ganged together or anchored to the floor or wall.

### DRAWERS/SHELVES

- Drawer interlocking system
- Three-stage, anti-bounceback suspension
- Pre-installed file bars
- Side-to-side file bars for letter, legal and A4
- Looped full pull
- Front-to-back file bars – optional
- Label holder
- Fixed front drawers – available
- Receding door, roll-out shelves – available
- Slotted, pull-out shelves with rolled edge
- Full-height dividers – optional

### LATERAL FILES 1200 SERIES

- Receding door series features 16 gauge, spring loaded hinges
- Mig welded top corners
- Thicker receding door with redesigned pivot motion to prevent door rub
- Half height drawers - optional
- Premium drawer slides with black zinc coating for smoother, quieter

### MOTION

- Salt spray resistance treatment
- Durable epoxy powder coating
- Superior locking system with anti-lift mechanism
- Large standard color palette
- ANSI / BIFMA approved
- CSGB approved

### CONSTRUCTION

- Top stiffener bar
- Corner gussets
- 18 – 20 gauge cold-rolled steel
- Four (4) ganging drill points are marked to ensure correct positioning
- Cam lock included
- Leveling glides
- Counterweights are recommended in all heights/widths – optional

## STANDARD PAINT COLORS

Evolve Colors		Evolve Colors (10% upcharge)	
BLK	Black	TUN	Tungsten
CHR	Charcoal		
SIL	Silver		
TPE	Taupe		
NEV	Nevada		
DWT	Designer White		
STL	Steel		

## ADDITIONAL STANDARD COLORS (FOR STORAGE ITEMS ONLY)

### GLOBAL COLORS

DPT	Desert Putty
TSA	Tahiti Sand
LGR	Light Grey
BGR	Business Grey
GRY	Grey

### PREMIUM COLORS

F05	Moss
F07	Metro
F09	Claret
F19	Navy
F23	Cloud
F28	Willow
F29	Bone
F30	Ivory
F32	Stone
F33	Ice
F35	Oyster

### TEXTURED COLORS

U04	Black Coffee
T19	Dark Chocolate
T20	Cappacino
J52	Mocha
J23	Vanilla

\*Extended lead times for premium paints apply. Contact Evolve Customer Support for details.

Global matte paint finishes are available on most Evolve Storage pieces without an up charge regardless of quantities.

All Mica and Metallic paint finishes will incur a minimum up charge of 10%.

All non-standard paint finishes must be approved by Evolve prior to placing an order.

## GENERAL WARRANTY INFORMATION

- Evolve warrants all components of metal storage and filing for the lifetime of the product to the original purchaser.



This page provides a three dimensional view of a sample configuration highlighting each storage component required when specifying this configuration.

## Components

- A. EVS12BBF      Box, Box, File Pedestal
- B. EVSSL          Low-Profile Shelf
- C. EVSOF          Overhead Flipper Door Storage Unit

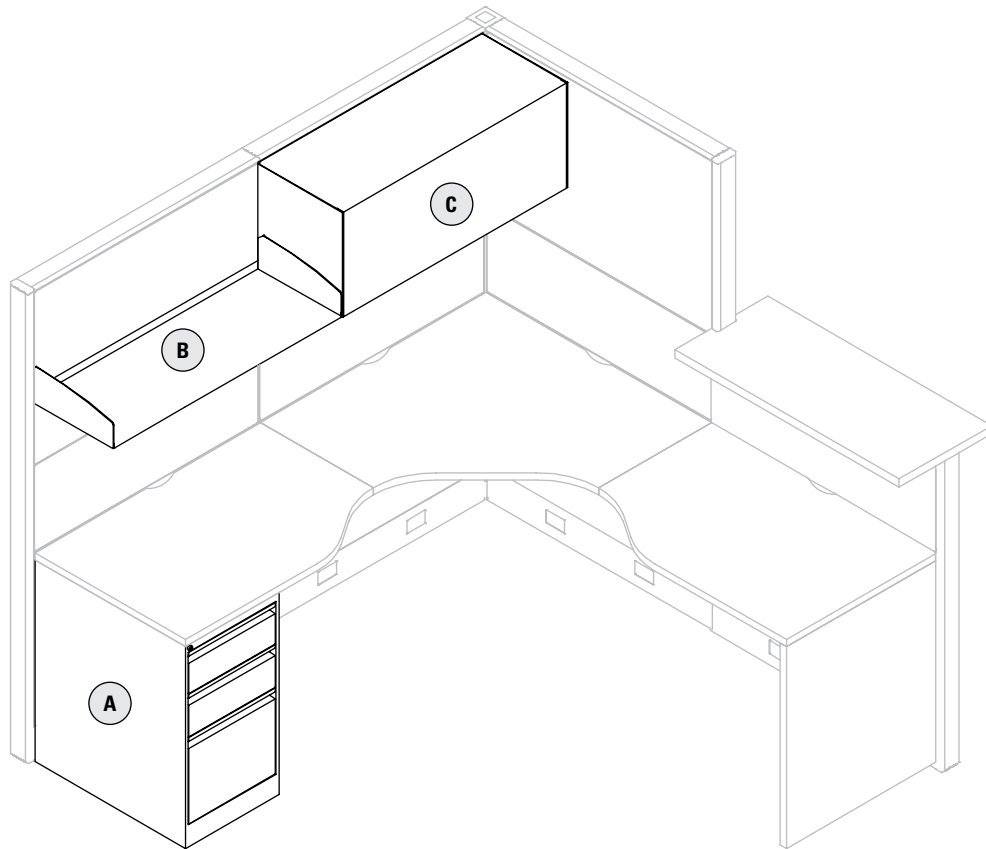



## INTERIOR CLEAR OPENING HEIGHT DIMENSIONS

### "B" Opening

Fixed Front Drawer	13"
Receding Door and Roll-Out Shelf	12 1/8"
Receding Door and Fixed Shelf	12"
Fixed Shelf and no Receding Door	12 3/4"

### "B" and "L" Opening

Drawer – Depth	15 3/4"
Roll-Out Shelf – Depth	15 3/4"
Fixed Shelf – Depth	15 3/4"

### "L" Opening

Fixed Front Drawer	10 7/8"
Receding Door and Roll-Out Shelf	10"
Receding Door and Fixed Shelf	9 7/8"
Fixed Shelf and no Receding Door	10 5/8"

## INTERIOR CLEAR OPENING WIDTH DIMENSIONS AND FILING CAPACITY

### 30" Wide Cabinet

Fixed Front Drawer	26 9/16"
Receding Door and Roll-Out Shelf	26 9/16"
Receding Door and Fixed Shelf	26 9/16"

### 42" Wide Cabinet

Fixed Front Drawer	38 9/16"
Receding Door and Roll-Out Shelf	38 9/16"
Receding Door and Fixed Shelf	38 9/16"

### 36" Wide Cabinet

Fixed Front Drawer	32 9/16"
Receding Door and Roll-Out Shelf	32 9/16"
Receding Door and Fixed Shelf	32 3/16"

## OPENING CAPACITIES 30" WIDE UNITS

### Letter

"B" and "L" Openings  
Fixed Front Drawers and  
Roll-Out Shelves

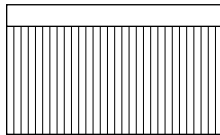

Capacity — 26 9/16"  
Accessories required HFB30

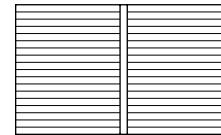

Capacity — 26 1/2"  
Accessories required HFB30 and one pair of FBB  
Not recommended for "L" openings with Roll-Out Shelves

### Legal

"B" and "L" Openings  
Fixed Front Drawers and  
Roll-Out Shelves

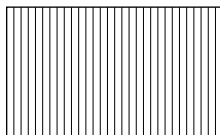

Capacity — 26 9/16"  
Accessories required HFB30

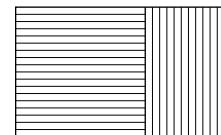

Capacity — 26 5/16"  
Accessories required HFB30 and one pair FBB  
Not recommended for "L" openings with Roll-Out Shelves

### EDP

"B" Opening  
Fixed Front Drawer ONLY

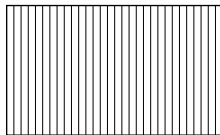

Capacity — 26 9/16"  
Accessories required HFB30 and one pair EDPS



**OPENING CAPACITIES 36" WIDE UNITS**

**Letter**

"B" and "L" Openings  
Fixed Front Drawers and  
Roll-Out Shelves

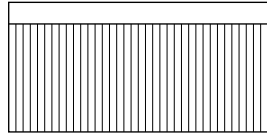

Capacity — 32 9/16"  
Accessories required HFB36

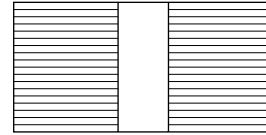

Capacity — 31 1/2"  
Accessories required HFB36 and one pair of FBB  
Not recommended for "L" openings with Roll-Out Shelves

**Legal**

"B" and "L" Openings  
Fixed Front Drawers and  
Roll-Out Shelves

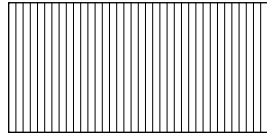

Capacity — 32 9/16"  
Accessories required HFB36

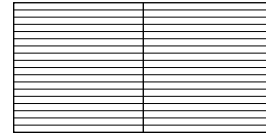

Capacity — 31 1/2"  
Accessories required HFB36 and one pair FBB  
Not recommended for "L" openings with Roll-Out Shelves

**EDP**

"B" Opening  
Fixed Front Drawer ONLY

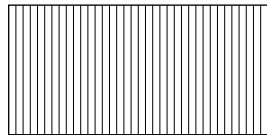

Capacity — 32 9/16"  
Accessories required HFB36 and one pair EDPS

**OPENING CAPACITIES 42" WIDE UNITS**

**Letter**

"B" and "L" Openings  
Fixed Front Drawers and  
Roll-Out Shelves

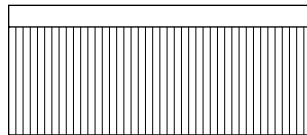

Capacity — 38 9/16"  
Accessories required HFB42

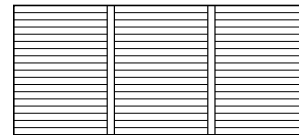

Capacity — 47 1/4"  
Accessories required HFB30 and one pair of FBB  
Not recommended for "L" openings with Roll-Out Shelves

**Legal**

"B" and "L" Openings  
Fixed Front Drawers and  
Roll-Out Shelves

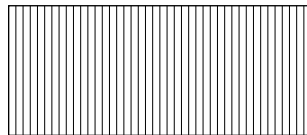

Capacity — 38 9/16"  
Accessories required HFB42

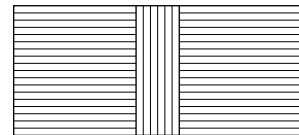

Capacity — 31 1/2"  
Accessories required HFB36 and one pair FBB  
Not recommended for "L" openings with Roll-Out Shelves

**EDP**

"B" Opening  
Fixed Front Drawer ONLY

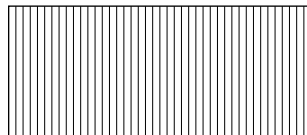

Capacity — 38 9/16"  
Accessories required HFB42 and one pair EDPS

**EVSOFF - OVERHEAD FLIPPER DOOR STORAGE UNIT**

- Door retracts up and over the cabinet.
- Ready for quick assembly on site.
- Quality steel construction.
- 60" unit is reinforced for proper weight distribution.
- Inside dimensions: 12" H x 11.75" D.
- Lock not included (specify EVSLK12).

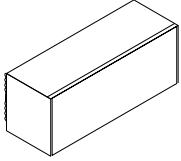
	DESCRIPTION	PRODUCT CODE	LIST PRICE	DIMENSIONS/INCHES		
				H	D	W
	Overhead Flipper Door Storage Unit	EVSOFF1224	327	14.5	12	24
		EVSOFF1230	338	14.5	12	30
		EVSOFF1236	375	14.5	12	36
		EVSOFF1242	413	14.5	12	42
		EVSOFF1248	449	14.5	12	48
		EVSOFF1254	488	14.5	12	54
		EVSOFF1260	524	14.5	12	60

**EVSOFF - FULL PULL OVERHEAD FLIPPER DOOR STORAGE UNIT**

- Door retracts up and over the cabinet.
- Ready for quick assembly on site.
- Quality steel construction.
- 60" unit is reinforced for proper weight distribution.
- Inside dimensions: 13.25" H x 12.75" D
- Includes lock
- When ordering EVSOFF13 lock only, specify part code EVSLK13 (\$69 list).

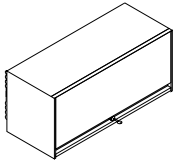
	DESCRIPTION	PRODUCT CODE	LIST PRICE	DIMENSIONS/INCHES		
				H	D	W
	Full Pull Overhead Flipper Door Storage Unit	EVSOFF1324	438	16	14.5	24
		EVSOFF1330	445	16	14.5	30
		EVSOFF1336	459	16	14.5	36
		EVSOFF1342	483	16	14.5	42
		EVSOFF1348	515	16	14.5	48
		EVSOFF1354	544	16	14.5	54
		EVSOFF1360	574	16	14.5	60

**EVSOFF - 17" OVERHEAD FLIPPER DOOR STORAGE UNIT**

- Door retracts up and over the cabinet.
- Ready for quick assembly on site.
- Quality steel construction.
- Inside dimensions: 15" H x 13" D.
- Lock not included (specify EVSLK12).

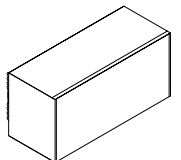
	DESCRIPTION	PRODUCT CODE	LIST PRICE	DIMENSIONS/INCHES		
				H	D	W
	17" Overhead Flipper Door Storage Unit	EVSOFF1724	1046	17	14.5	24
		EVSOFF1730	1083	17	14.5	30
		EVSOFF1736	1136	17	14.5	36
		EVSOFF1742	1195	17	14.5	42
		EVSOFF1748	1270	17	14.5	48



**EVSOFF - OVERHEAD FLIPPER DOOR STORAGE UNIT - FULLY ASSEMBLED**

- Quality steel construction.
- 60" unit is reinforced for proper weight distribution.
- Inside dimensions: 14" H x 14.75" D.
- Door retracts inside storage unit.
- Lock is included
- Task lights must be screwed into support channel underneath shelf, standard spring mounts will not work.

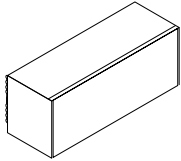
	DESCRIPTION	PRODUCT CODE	LIST PRICE	DIMENSIONS/INCHES		
				H	D	W
	Overhead Flipper Door Storage Unit - Fully Assembled	EVSOFF1624	582	17.5	16	24
		EVSOFF1630	597	17.5	16	30
		EVSOFF1636	627	17.5	16	36
		EVSOFF1642	666	17.5	16	42
		EVSOFF1648	710	17.5	16	48
		EVSOFF1654	750	17.5	16	54
		EVSOFF1660	782	17.5	16	60

**EVSOGD - OVERHEAD WITH SLIDING GLASS DOORS**

- Sliding overheads are specially designed EVSOFF12 cabinets with sliding/glass doors.
- Glass overheads available in standard widths of 24" - 60".
- Inside depth - 12"; Inside height - 12".
- Available in Tempered Frosted Glass option only.
- Overhead unit does not come with a lock option.
- Body of unit made of quality steel construction.
- Tracks for sliding glass door available in Tungsten only.

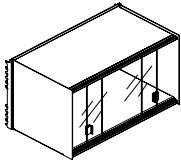
	DESCRIPTION	PRODUCT CODE	LIST PRICE	DIMENSIONS/INCHES		
				H	D	W
	Overhead with Sliding Glass Doors	EVSOGD1224	712	14.5	12	24
		EVSOGD1230	720	14.5	12	30
		EVSOGD1236	747	14.5	12	36
		EVSOGD1242	790	14.5	12	42
		EVSOGD1248	844	14.5	12	48
		EVSOGD1254	872	14.5	12	54
		EVSOGD1260	903	14.5	12	60

**EVSOGDL - OVERHEAD WITH SLIDING GLASS DOORS WITH LOCK UNIT**

- Sliding overheads are specially designed EVSOFF12 cabinets with sliding/glass doors.
- Glass Overheads available in standard widths of 24" - 60".
- Inside depth - 12"; Inside height - 12".
- Available in Tempered Frosted Glass option only
- Body of unit made of quality steel construction.
- Tracks for sliding glass door available in Tungsten only
- Push in lock. No keys alike.

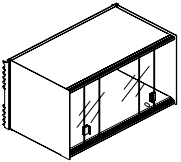
	DESCRIPTION	PRODUCT CODE	LIST PRICE	DIMENSIONS/INCHES		
				H	D	W
	Overhead with Sliding Glass Doors (Lockable)	EVSOGDL1224	744	14.5	12	24
		EVSOGDL1230	753	14.5	12	30
		EVSOGDL1236	779	14.5	12	36
		EVSOGDL1242	822	14.5	12	42
		EVSOGDL1248	877	14.5	12	48
		EVSOGDL1254	905	14.5	12	54
		EVSOGDL1260	935	14.5	12	60

**EVSOD - DOUBLE WALL OVERHEAD FLIPPER DOOR STORAGE UNIT**

- Easy and quick assembly on site.
- Quality steel construction.
- Inside height - 13"; Inside depth - 13"
- Includes lock.
- This model is subject to minimum quantity requirements, when ordering in a premium paint finish. See page 242 for more details.

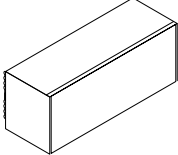
	DESCRIPTION	PRODUCT CODE	LIST PRICE	DIMENSIONS/INCHES		
				H	D	W
	Double Wall Overhead Flipper Door Storage Unit	EVSOD1330	552	15.4	14.7	30
		EVSOD1336	568	15.4	14.7	36
		EVSOD1342	585	15.4	14.7	42
		EVSOD1348	633	15.4	14.7	48
		EVSOD1354	651	15.4	14.7	54
		EVSOD1360	672	15.4	14.7	60

**EVSODS - DOUBLE WALL OVERHEAD WITH SHELF FLIPPER DOOR STORAGE UNIT**

- Easy and quick assembly on site.
- Quality steel construction.
- Inside height - 13".
- Inside depth - 13".
- Includes lock.
- This model is subject to minimum quantity requirements, when ordering in a premium paint finish. See page 242 for more details.

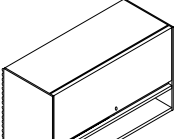
	DESCRIPTION	PRODUCT CODE	LIST PRICE	DIMENSIONS/INCHES		
				H	D	W
	Double Wall Overhead with Shelf Flipper Door Storage Unit	EVSODS1330	627	22.4	14.7	30
		EVSODS1336	650	22.4	14.7	36
		EVSODS1342	676	22.4	14.7	42
		EVSODS1348	733	22.4	14.7	48
		EVSODS1354	758	22.4	14.7	54
		EVSODS1360	785	22.4	14.7	60

**EVSODGD - DOUBLE WALL OVERHEAD GLASS SLIDING DOOR UNIT**

- Sliding overheads are specially designed EVSOD cabinets with sliding/glass doors.
- Available in Tempered Frosted Glass option only.
- Glass Overheads available in standard widths of 30"- 60".
- Quality steel construction.
- Panel mount (mounting brackets are included).
- Inside height - 13".
- Inside depth - 13".
- Tracks for sliding glass door available in Tungsten only.
- This model is subject to minimum quantity requirements, when ordering in a premium paint finish. See page 242 for more details.

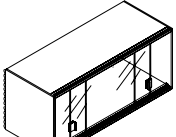
	DESCRIPTION	PRODUCT CODE	LIST PRICE	DIMENSIONS/INCHES		
				H	D	W
	Double Wall Overhead Glass Sliding Door Unit	EVSODGD1330	547	15.4	14.7	30
		EVSODGD1336	568	15.4	14.7	36
		EVSODGD1342	621	15.4	14.7	42
		EVSODGD1348	667	15.4	14.7	48
		EVSODGD1354	701	15.4	14.7	54
		EVSODGD1360	733	15.4	14.7	60



**EVSODGDL - DOUBLE WALL OVERHEAD GLASS SLIDING DOOR WITH LOCK UNIT**

- Sliding overheads are specially designed EVSOD cabinets with sliding/glass doors.
- Available in Tempered Frosted Glass option only.
- Glass Overheads available in standard widths of 30" - 60".
- Quality steel construction.
- Panel mount (mounting brackets are included).
- Inside height - 13".
- Inside depth - 13".
- Tracks for sliding glass door available in Tungsten only.
- Push in lock; No keys alike. Cannot be keyed alike.
- This model is subject to minimum quantity requirements, when ordering in a premium paint finish. See page 242 for more details.

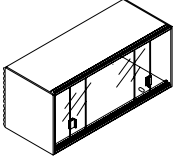
	DESCRIPTION	PRODUCT CODE	LIST PRICE	DIMENSIONS/INCHES		
				H	D	W
	Double Wall Overhead	EVSODGDL1330	604	15.4	14.7	30
	Glass Sliding Door with Lock Unit	EVSODGDL1336	624	15.4	14.7	36
		EVSODGDL1342	677	15.4	14.7	42
		EVSODGDL1348	723	15.4	14.7	48
		EVSODGDL1354	758	15.4	14.7	54
		EVSODGDL1360	787	15.4	14.7	60

**EVSODSGD - DOUBLE WALL OVERHEAD WITH SHELF GLASS SLIDING DOOR UNIT**

- Sliding overheads are specially designed EVSOD cabinets with sliding/glass doors.
- Available in Tempered Frosted Glass option only.
- Glass Overheads available in standard widths of 30" - 60".
- Quality steel construction.
- Inside height - 13".
- Inside depth - 13".
- Tracks for sliding Glass door available in Tungsten only.
- This model is subject to minimum quantity requirements, when ordering in a premium paint finish. See page 242 for more details.

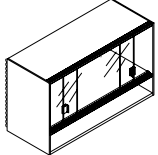
	DESCRIPTION	PRODUCT CODE	LIST PRICE	DIMENSIONS/INCHES		
				H	D	W
	Double Wall Overhead with Shelf	EVSODSGD1330	614	22.4	14.7	30
	Glass Sliding Door Unit	EVSODSGD1336	637	22.4	14.7	36
		EVSODSGD1342	696	22.4	14.7	42
		EVSODSGD1348	748	22.4	14.7	48
		EVSODSGD1354	786	22.4	14.7	54
		EVSODSGD1360	819	22.4	14.7	60

**EVSODSGDL - DOUBLE WALL OVERHEAD WITH SHELF GLASS SLIDING DOOR UNIT WITH LOCK UNIT**

- Sliding overheads are specially designed EVSOD cabinets with sliding/glass doors.
- Available in Tempered Frosted Glass option only.
- Glass Overheads available in standard widths of 30" - 60".
- Quality steel construction.
- Inside height - 13".
- Inside depth - 13".
- Tracks for sliding glass door available in Tungsten only.
- Push in lock; No keys alike. Cannot be keyed alike.
- This model is subject to minimum quantity requirements, when ordering in a premium paint finish. See page 242 for more details.

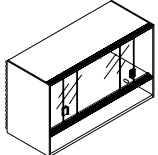
	DESCRIPTION	PRODUCT CODE	LIST PRICE	DIMENSIONS/INCHES		
				H	D	W
	Double Wall Overhead with Shelf	EVSODSGDL1330	671	22.4	14.7	30
	Glass Sliding Door with Lock Unit	EVSODSGDL1336	693	22.4	14.7	36
		EVSODSGDL1342	753	22.4	14.7	42
		EVSODSGDL1348	803	22.4	14.7	48
		EVSODSGDL1354	843	22.4	14.7	54
		EVSODSGDL1360	874	22.4	14.7	60

## EVSDAOH - DUAL ACCESS OVERHEAD

- Inside dimensions 13" high x 13" deep.
- Laminate Overhead. Available in standard Evolve laminate finishes.
- Top mount on panels.
- Dual Access Overhead Support Brackets to be ordered separately.

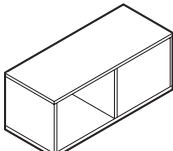
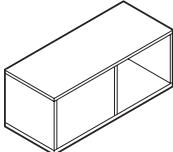
	DESCRIPTION	PRODUCT CODE	LIST PRICE	DIMENSIONS/INCHES		
				H	D	W
	Dual Access Overhead - Left	EVSDAOHL36	744	15	14.125	36
		EVSDAOHL42	808	15	14.125	42
		EVSDAOHL48	845	15	14.125	48
		EVSDAOHL54	909	15	14.125	54
		EVSDAOHL60	945	15	14.125	60
	Dual Access Overhead - Right	EVSDAOHR36	744	15	14.125	36
		EVSDAOHR42	808	15	14.125	42
		EVSDAOHR48	845	15	14.125	48
		EVSDAOHR54	909	15	14.125	54
		EVSDAOHR60	945	15	14.125	60

## EVSDAOHBKTE - END OF RUN BRACKET

- Bracket supports dual access overhead on one side only
- Includes one bracket, aluminum insert and end of run plastic cap
- End of run plastic cap attaches to end of run trim
- Bracket available in standard Evolve paint finishes

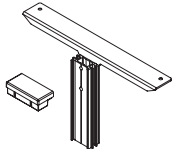
	DESCRIPTION	PRODUCT CODE	LIST PRICE	DIMENSIONS/INCHES		
				H	D	W
	End of Run Single Bracket	EVSDAOHBKTE	62	6.5	12	2.5

## EVSDAOHBKTS - INLINE SINGLE BRACKET

- Bracket supports dual access overhead on one side only
- Includes one bracket, aluminum insert and inline plastic cap
- Inline plastic cap and top trim align
- Bracket available in standard Evolve paint finishes
- Single clamps must be used when inline single bracket is used

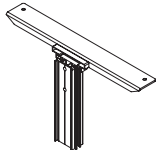
	DESCRIPTION	PRODUCT CODE	LIST PRICE	DIMENSIONS/INCHES		
				H	D	W
	Inline Single Bracket	EVSDAOHBKTS	62	6.5	12	2.5



**EVSDAOHBKTD - DOUBLE BRACKET**

- Double Bracket supports sides of dual access overheads when overhead are side by side.
- Includes two brackets, aluminum insert and plastic caps.
- Plastic caps installed between brackets
- Brackets available in standard Evolve paint finishes.
- Single clamps must be used when double bracket is used.

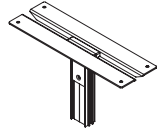
	DESCRIPTION	PRODUCT CODE	LIST PRICE	DIMENSIONS/INCHES		
				H	D	W
	Double Bracket	EVSDAOHBKTD	124	6.5	12	4

**EVSSOH - TOP MOUNT KD OVERHEAD WITH SLIDING GLASS DOOR LEFT**

- Inside dimensions 13"high x 13"deep.
- Laminate Side Walls and Divider, available in standard laminate finishes
- Metal Shelves and Back Wall, available in standard paint finishes
- Available in Temperate Frosted Glass only
- Tracks for sliding glass available in Tungsten only
- Top mount on panels
- Ready for quick assembly on site
- Top Mount Overhead Support Brackets to be ordered separately

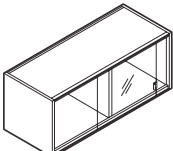
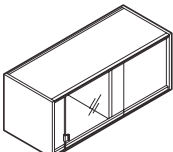
	DESCRIPTION	PRODUCT CODE	LIST PRICE	DIMENSIONS/INCHES		
				H	D	W
	Top Mount KD Overhead - Left	EVSSOHL30	815	15	15	30
		EVSSOHL36	901	15	15	36
		EVSSOHL42	992	15	15	42
		EVSSOHL48	1055	15	15	48
		EVSSOHL54	1119	15	15	54
		EVSSOHL60	1221	15	15	60
	Top Mount KD Overhead - Right	EVSSOHR30	815	15	15	30
		EVSSOHR36	901	15	15	36
		EVSSOHR42	992	15	15	42
		EVSSOHR48	1055	15	15	48
		EVSSOHR54	1119	15	15	54
		EVSSOHR60	1221	15	15	60

**EVSSOHBKTEE - END OF RUN BRACKET**

- Bracket supports Top mount KD overhead on one side only
- Includes one bracket , aluminum insert and end of run plastic cap
- End of run plastic cap attaches to end of run trim
- Bracket available in standard Evolve paint finishes

	DESCRIPTION	PRODUCT CODE	LIST PRICE	DIMENSIONS/INCHES		
				H	D	W
	End of Run Single Bracket	EVSSOHBKTEE	62	7.5	12	1.5



**EVSSOHBKTS - INLINE SINGLE BRACKET**

- Bracket supports Top mount KD overhead on one side only
- Includes one bracket , aluminum insert and inline plastic cap
- Inline plastic cap and top trim align
- Bracket available in standard Evolve paint finishes
- Single clamps must be used when inline single bracket is used

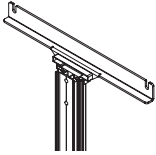
	DESCRIPTION	PRODUCT CODE	LIST PRICE	DIMENSIONS/INCHES		
				H	D	W
	Inline Single Bracket	EVSSOHBKTS	62	7.5	12	1.5

**EVSSOHBKTD - DOUBLE BRACKET**

- Double Bracket supports sides of Top Mount KD overheads when overhead are side by side
- Includes two brackets, aluminum insert and plastic caps
- Plastic caps installed between brackets
- Brackets available in standard Evolve paint finishes
- Single clamps must be used when double bracket is used

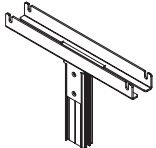
	DESCRIPTION	PRODUCT CODE	LIST PRICE	DIMENSIONS/INCHES		
				H	D	W
	Double Bracket	EVSSOHBKTD	124	7.5	12	2

**EVADA-PM - EASY-UP OVERHEAD STORAGE UNIT**

- Panel Mounted Overhead Storage with metal sides and opaque door that retracts on top of the unit
- Meets CSA B651 Barrier Free Design & ADA (American Disabilities Act).
- 16" high units accept standard and A4 binders.
- All shelves are reinforced for proper weight distribution.
- Inside dimensions: 14.25" high x 12" deep.
- Unit includes attachment hardware, lock and mounting brackets. Back not included.
- Not recommended for use with wall adapter.
- Unit can be converted into an upmount unit in the field by using EVADAxKIT.
- Shipped partially assembled.
- Available in standard Evolve paint colors only. Door made of opaque plastic. \*\*add 10% upcharge for Tungsten

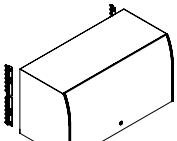
	DESCRIPTION	PRODUCT CODE	LIST PRICE	DIMENSIONS/INCHES		
				H	D	W
	Easy-Up Overhead Storage Unit	EVADA30PM	678	16	14.2	30
		EVADA36PM	731	16	14.2	36
		EVADA42PM	782	16	14.2	42
		EVADA48PM	834	16	14.2	48
		EVADA54PM	887	16	14.2	54
		EVADA60PM	937	16	14.2	60



## EVADA-UM - EASY-UP UPMOUNT OVERHEAD STORAGE UNIT

- Meets CSA B651 Barrier Free Design & ADA (American Disabilities Act).
- 16" high units accept standard and A4 binders.
- All shelves are reinforced for proper weight distribution.
- Inside dimensions: 14.25" high x 12" deep.
- Unit includes attachment hardware, lock, mounting cantilevers and has a complete back.
- Shipped partially assembled.
- Available in standard Evolve paint colors only. Door made of opaque plastic.

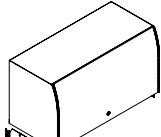
	DESCRIPTION	PRODUCT CODE	LIST PRICE	DIMENSIONS/INCHES		
				H	D	W
	Easy-Up Upmount Overhead Storage Unit	EVADA30UM	804	16	14.2	30
		EVADA36UM	843	16	14.2	36
		EVADA42UM	889	16	14.2	42
		EVADA48UM	936	16	14.2	48
		EVADA54UM	985	16	14.2	54
		EVADA60UM	1040	16	14.2	60

## EVSHJB - J BARS FOR DOUBLE WALL OVERHEAD

- Converts existing panel mounted Double Wall Overhead EVSOD13, EVSODGD13 OR EVSODGDL13 into a wall mounted overhead.
- Available in Evolve standard paint finishes.
- Note: Care should be taken to fasten "J" bars only to wall studs with correct fasteners. Failure to do so may result in collapse of unit and subsequent possible personal injury.

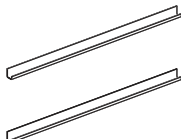
	DESCRIPTION	PRODUCT CODE	LIST PRICE	DIMENSIONS/INCHES		
				H	D	W
	J Bars for Double Wall Overhead	EVSHJB30	18	1.4	30	1
		EVSHJB36	20	1.4	36	1
		EVSHJB42	22	1.4	42	1
		EVSHJB48	25	1.4	48	1
		EVSHJB54	28	1.4	54	1
		EVSHJB60	31	1.4	60	1

## EVSSL - LOW-PROFILE SHELF

- 12" deep panel-mounted storage shelf with back lip.
- Includes attachment hardware.

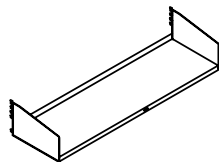
	DESCRIPTION	PRODUCT CODE	LIST PRICE	DIMENSIONS/INCHES		
				H	D	W
	Low Profile Shelf	EVSSL1224	88	5	12	24
		EVSSL1230	95	5	12	30
		EVSSL1236	104	5	12	36
		EVSSL1242	107	5	12	42
		EVSSL1248	112	5	12	48
		EVSSL1254	117	5	12	54
		EVSSL1260	123	5	12	60

## EVSOH - HIGH-PROFILE SHELF

- 12" deep panel-mounted storage shelf with back lip.
- Includes attachment hardware.

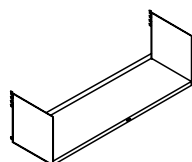
	DESCRIPTION	PRODUCT CODE	LIST PRICE	DIMENSIONS/INCHES		
				H	D	W
	High Profile Shelf	EVSOH1224	174	14.5	12	24
		EVSOH1230	194	14.5	12	30
		EVSOH1236	203	14.5	12	36
		EVSOH1242	210	14.5	12	42
		EVSOH1248	215	14.5	12	48
		EVSOH1254	224	14.5	12	54
		EVSOH1260	226	14.5	12	60

**EVSSC - CORNER SHELF KIT**

- Used in conjunction with a Low or High Profile Shelf.
- Includes handed corner side panel, flat bracket and hardware.
- Corner shelf must be specified 12" smaller than panel width.

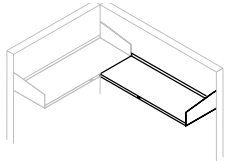
DESCRIPTION	PRODUCT CODE	LIST PRICE	DIMENSIONS/INCHES		
			H	D	W
 <p>Corner Shelf Kit</p>	EVSSC1224L	81	5	12	24
	EVSSC1230L	84	5	12	30
	EVSSC1236L	88	5	12	36
	EVSSC1224R	81	5	12	24
	EVSSC1230R	84	5	12	30
	EVSSC1236R	88	5	12	36

**EVSLs - LAMINATED SHELF**

- Laminated panel mounted wood shelf
- Shelf thickness is 1".
- Available in LP only.
- Includes attachment hardware.

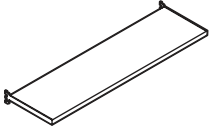
DESCRIPTION	PRODUCT CODE	LIST PRICE	DIMENSIONS/INCHES		
			H	W	D
 <p>Laminated Shelf</p>	EVSLs0818	143	1.125	18	8.5
	EVSLs0824	156	1.125	24	8.5
	EVSLs0830	168	1.125	30	8.5
	EVSLs0836	180	1.125	36	8.5
	EVSLs0842	193	1.125	42	8.5
	EVSLs0848	205	1.125	48	8.5

**EVHV - SINGLE SLOTTED WALL ADAPTER**

- To attach system components to a fixed wall. The vertical wall adapter is a "U" shaped channel with a vertical row of 1" slots on center.
- Mounting hardware not included. Mounting hardware selection to be based on wall material.
- Use of wall rack requires lower tooth of top hook on cantilever or shelf to be notched in the field.
- Available in standard paint colors.
- Shipped & priced per pair.

**NOTE:**

- Care should be taken to mount adapters only to wall studs using correct fasteners. Failure to do this may result in collapse of the unit and subsequent possible personal injury.

DESCRIPTION	PRODUCT CODE	LIST PRICE	DIMENSIONS/INCHES	
			D	H
 <p>Single Slotted Wall Track</p>	EVHV01	61	60	.5



**EVADA-KIT - UPMOUNT CONVERSION KIT**

- Converts an existing panel overhead storage unit EVADA-PM to an upmounted unit (EVADA-UM). 66" high panels.
- When used on a 54" high panel, the top of the overhead will match the height of
  - Kit includes a back panel for the overhead and cantilevers.

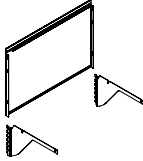
	DESCRIPTION	PRODUCT CODE	LIST PRICE	DIMENSIONS/INCHES		
				H	D	W
	Upmount Conversion Kit	EVADA30KIT	163	16	30	2
		EVADA36KIT	172	16	36	2
		EVADA42KIT	182	16	42	2
		EVADA48KIT	191	16	48	2
		EVADA54KIT	199	16	54	2
		EVADA60KIT	209	16	60	2

**EVADAPMKIT - PANEL MOUNT CONVERSION KIT**

- Converts an existing up mount overhead storage unit EVADA-UM to a panel mounted overhead storage unit EVADA-PM.
- Kit includes panel mounted brackets.

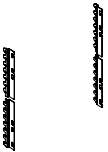
	DESCRIPTION	PRODUCT CODE	LIST PRICE	DIMENSIONS/INCHES		
				H	D	W
	Panel Mount Conversion Kit	EVADAPMKIT	36	16	2	5

**EVSQB - OVERHEAD BACK WALL**

- Metal back wall attaches to EVSOF12 overhead to provide interior security.
- Can be field installed or retrofitted.

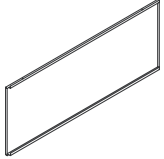
	DESCRIPTION	PRODUCT CODE	LIST PRICE	DIMENSIONS/INCHES		
				H	D	W
	Overhead Back Wall	EVSQB24	44	14	.5	24
		EVSQB30	52	14	.5	30
		EVSQB36	60	14	.5	36
		EVSQB42	67	14	.5	42
		EVSQB48	74	14	.5	48
		EVSQB54	82	14	.5	54
		EVSQB60	88	14	.5	60

**EVSOFPB - FULL PULL OVERHEAD BACK WALL**

- Metal back wall attaches to EVSOF13 overhead to provide interior security.
- Can be field installed or retrofitted.

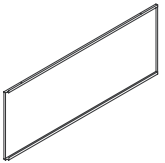
DESCRIPTION	PRODUCT CODE	LIST PRICE	DIMENSIONS/INCHES		
			H	D	W
 Full Pull Overhead Back Wall	EVSOFPB24	44	14	.5	24
	EVSOFPB30	52	14	.5	30
	EVSOFPB36	60	14	.5	36
	EVSOFPB42	67	14	.5	42
	EVSOFPB48	74	14	.5	48
	EVSOFPB54	82	14	.5	54
	EVSOFPB60	88	14	.5	60

**EVSOIB - INTERNATIONAL OVERHEAD BACK WALL**

- Metal back wall attaches to EVSOF17 overhead to provide interior security.
- Can be field installed or retrofitted.

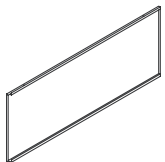
DESCRIPTION	PRODUCT CODE	LIST PRICE	DIMENSIONS/INCHES		
			H	D	W
 International Overhead Back Wall	EVSOIB24	47	17	.5	24
	EVSOIB30	56	17	.5	30
	EVSOIB36	62	17	.5	36
	EVSOIB42	70	17	.5	42
	EVSOIB48	78	17	.5	48

**EVAOMFD - DRY ERASE MARKER BOARD**

- Adheres magnetically to the front of Flipper Door (EVSOF) Overhead.
- Use erasable writeboard markers only.

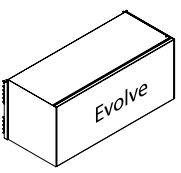
DESCRIPTION	PRODUCT CODE	LIST PRICE	DIMENSIONS/INCHES		
			H	D	W
 Dry Erase Marker Board	EVAOMFD24	216	14.4	.5	22.8
	EVAOMFD30	249	14.4	.5	28.8
	EVAOMFD36	281	14.4	.5	34.8
	EVAOMFD42	319	14.4	.5	40.8
	EVAOMFD48	351	14.4	.5	46.8
	EVAOMFD54	379	14.4	.5	52.8
	EVAOMFD60	401	14.4	.5	58.8

**EVSOFD - OVERHEAD DIVIDER**

- Attaches to overhead top shelf inside the overhead.
- Provides rigid division for books and binders.
- Not for use with 1600 series overhead storage units.
- Can be used with a hutch.

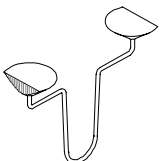
DESCRIPTION	PRODUCT CODE	LIST PRICE	DIMENSIONS/INCHES		
			H	D	W
 Overhead Divider	EVSOFD01	47	21	30	



**EVS12BBF - TWELVE SERIES BOX/BOX/FILE PEDESTAL - WORKSURFACE SUPPORTING**

- Freestanding/Worksurface Supporting Pedestal.
- Includes one pencil tray and one divider.
- Lock is standard. Lock positioned on the front face, right side.
- Can be retrofit to a panel using a pedestal bracket, please specify EVHBP1. Pedestal bracket is specified separately, see Worksurfaces for listing.

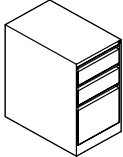
	DESCRIPTION	PRODUCT CODE	LIST PRICE	DIMENSIONS/INCHES		
				H	D	W
	Twelve Series Box/Box/File Pedestal - Worksurface Supporting	EVS1218BBF	456	27.65	18	15
		EVS1223BBF	461	27.65	23	15
		EVS1224BBF	461	27.65	24	15
		EVS1229BBF	509	27.65	29	15
		EVS1230BBF	509	27.65	30	15

**EVS12FF - TWELVE SERIES FILE/FILE PEDESTAL - WORKSURFACE SUPPORTING**

- Freestanding/Worksurface Supporting Pedestal with long pull and double wall drawer front construction.
- Lock is standard. Lock positioned on the front face, right side.
- Can be retrofit to a panel using a pedestal bracket, please specify EVHBP1. Pedestal bracket is specified separately, see Worksurfaces for listing.

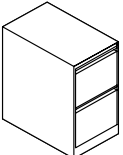
	DESCRIPTION	PRODUCT CODE	LIST PRICE	DIMENSIONS/INCHES		
				H	D	W
	Twelve Series File/File Pedestal - Worksurface Supporting	EVS1218FF	456	27.65	18	15
		EVS1223FF	461	27.65	23	15
		EVS1224FF	461	27.65	24	15
		EVS1229FF	509	27.65	29	15
		EVS1230FF	509	27.65	30	15

**EVS12BBFM - TWELVE SERIES MOBILE BOX/BOX/FILE PEDESTAL**

- Mobile Pedestal with flat front, double wall drawer construction.
- Includes one pencil tray and one divider.
- Includes 4 casters and 1 counterweight balance.
- Lock is standard. Lock positioned on the front face, right side.
- Not for use with pedestal seat cushion.
- Casters do not lock.

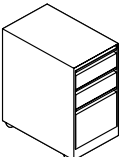
	DESCRIPTION	PRODUCT CODE	LIST PRICE	DIMENSIONS/INCHES		
				H	D	W
	Twelve Series Box/Box/File Mobile Pedestal	EVS1218BBFM	570	27.875	18	15
		EVS1223BBFM	580	27.875	23	15
		EVS1229BBFM	586	27.875	29	15

**EVS12FFM - TWELVE SERIES MOBILE FILE/FILE PEDESTAL**

- Mobile Pedestal with flat front, double wall drawer construction.
- Includes 4 casters and 1 counterweight balance.
- Lock is standard. Lock positioned on the front face, right side.
- Not for use with pedestal seat cushion.
- Casters do not lock.

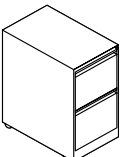
	DESCRIPTION	PRODUCT CODE	LIST PRICE	DIMENSIONS/INCHES		
				H	D	W
	Twelve Series File/File Mobile Pedestal	EVS1218FFM	570	27.875	18	15
		EVS1223FFM	580	27.875	23	15
		EVS1229FFM	586	27.875	29	15

**EVS12BF - TWELVE SERIES BOX/FILE PEDESTAL**

- Freestanding Pedestal.
- Includes one pencil tray and one divider.
- Lock is standard. Lock positioned on the front face, right side.
- Not worksurface supporting.

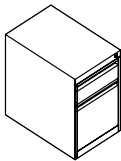
	DESCRIPTION	PRODUCT CODE	LIST PRICE	DIMENSIONS/INCHES		
				H	D	W
	Twelve Series Box/File Pedestal	EVS1218BF	456	21.75	18	15
		EVS1223BF	461	21.75	23	15
		EVS1229BF	509	21.75	29	15

**EVS12BFM - TWELVE SERIES MOBILE BOX/FILE PEDESTAL**

- Mobile Pedestal that includes one pencil tray and one divider.
- Includes factory installed counterweight balance.
- Lock is standard. Lock positioned on the front face, right side.
- Not for use with pedestal seat cushion.
- Casters do not lock.

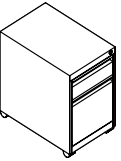
	DESCRIPTION	PRODUCT CODE	LIST PRICE	DIMENSIONS/INCHES		
				H	D	W
	Twelve Series Mobile Box/File Pedestal	EVS1218BFM	551	21.6	18	15
		EVS1223BFM	556	21.6	23	15
		EVS1229BFM	659	21.6	29	15

**EVS12BFLCM - MOBILE BOX/FILE PEDESTAL WITH 60MM CASTERS**

- Mobile pedestal that includes one pencil tray and one divider.
- Includes factory installed counterweight.
- Lock is standard.
- 60mm high castors.
- For use with pedestal seat cushion. See model below.
- Casters do not lock.

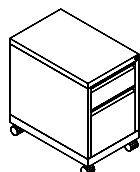
	DESCRIPTION	PRODUCT CODE	LIST PRICE	DIMENSIONS/INCHES		
				H	D	W
	Mobile Box/File Pedestal with 60mm Castors	EVS1219BFLCM	551	24.125	19	15
		EVS1223BFLCM	556	24.125	23	15
		EVS1229BFLCM	659	24.125	29	15

**EVCUSHION15 - PEDESTAL SEAT CUSHIONS**

- Cushions will have single stitching at the seams.
- Velcro included for quick attachment to pedestal file.
- 1" Cushion will have a rectilinear design on all sides.
- 2" Cushion will have waterfall edges Front and Back,
- Cushions are for use on EVS12BFLCM Mobile Pedestals.
- Please choose a fabric from the standard cushion textiles on pages 244-246.

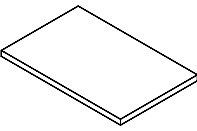
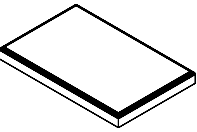
	DESCRIPTION	PRODUCT CODE	LIST PRICE/GRADES																DIM./INCH			YRDS	
			3	4	5	6	7	8	9	10	11	12	13	14	15	16	17	18	19	H	D		W
	Pedestal Seat	EVCUSHION15X18X1	133	155	172	198	234	251	284	337	378	423	516	615	714	814	1012	1211	1409	1	18	15	1
	Cushions - 1" Thick	EVCUSHION15X19X1	133	155	172	198	234	251	284	337	378	423	516	615	714	814	1012	1211	1409	1	19	15	1
		EVCUSHION15X23X1	150	172	189	215	251	268	301	354	395	440	533	632	731	831	1029	1228	1426	1	23	15	1
		EVCUSHION15X24X1	150	172	189	215	251	268	301	354	395	440	533	632	731	831	1029	1228	1426	1	24	15	1
		EVCUSHION15X29X1	199	228	250	285	333	356	400	471	525	585	709	842	974	1106	1371	1635	1900	1	29	15	1
	Pedestal Seat	EVCUSHION15X18X2	148	169	186	212	249	266	299	351	392	437	529	630	729	828	1026	1225	1424	2	18	15	2
	Cushions - 2" Thick	EVCUSHION15X19X2	148	169	186	212	249	266	299	351	392	437	529	630	729	828	1026	1225	1424	2	19	15	2
		EVCUSHION15X23X2	166	188	205	231	267	284	318	370	411	456	549	648	747	847	1045	1244	1442	2	23	15	2
		EVCUSHION15X24X2	166	188	205	231	267	284	318	370	411	456	549	648	747	847	1045	1244	1442	2	24	15	2
		EVCUSHION15X29X2	220	249	271	306	354	378	421	492	546	606	730	862	995	1127	1392	1656	1921	2	29	15	2
	EVCUSHION15X30X2	220	249	271	306	354	378	421	492	546	606	730	862	995	1127	1392	1656	1921	2	30	15	2	



**EVS1230DP - TWELVE SERIES LINEAR COMBINATION DOUBLE PEDESTAL**

- Measures 30" wide.
- Right (R) or Left (L) is determined by the side of cabinet with file drawer.
- Include one pencil tray and one divider.
- Freestanding/Worksurface Supporting Pedestal.
- Includes one lock.

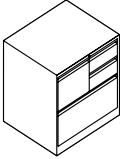
	DESCRIPTION	PRODUCT CODE	LIST PRICE	DIMENSIONS/INCHES		
				H	D	W
	Twelve Series Linear Combination	EVS1230DPL	1205	27.875	18	30
	Double Pedestal	EVS1230DPR	1205	27.875	18	30

**EVHPB - PEDESTAL BRACKET**

- Attaches to back edge of a pedestal and connects a pedestal to panel connector.
- Available in standard paint colors.

	DESCRIPTION	PRODUCT CODE	LIST PRICE	DIMENSIONS/INCHES		
				H		
	Pedestal Bracket	EVHPB1	23		11	

**EVS12X1H1F - ONE 1/2 HEIGHT FIXED FRONT & ONE 12" FIXED FRONT LATERAL FILE**

- 1/2 Height Box Drawer.
- 1 Fixed Drawer Front.
- Includes Lock.
- Counterweights must be specified on lateral files with pull out drawers, unless worksurface supporting, ganged together or anchored to the floor or wall.

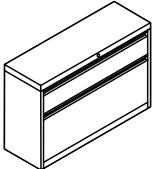
	DESCRIPTION	PRODUCT CODE	LIST PRICE	DIMENSIONS/INCHES		
				H	D	W
	One 1/2 Height Fixed Front &	EVS1230X1H1F	1066	21.75	18	30
	One 12" Fixed Front Lateral File	EVS1236X1H1F	1109	21.75	18	36
		EVS1242X1H1F	1148	21.75	18	42

**EVS12X1S1F - ONE 1/2 HEIGHT OPEN SHELF & ONE 12" FIXED FRONT LATERAL FILE**

- 1/2 Height Open Shelf.
- 1 Fixed Drawer Front.
- Includes Lock.
- Counterweights must be specified on lateral files with pull out drawers, unless worksurface supporting, ganged together or anchored to the floor or wall.

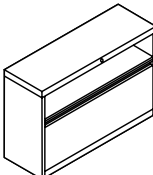
	DESCRIPTION	PRODUCT CODE	LIST PRICE	DIMENSIONS/INCHES		
				H	D	W
	One 1/2 Height Open Shelf &	EVS1230X1S1F	1032	21.75	18	30
	One 12" Fixed Front Lateral File	EVS1236X1S1F	1053	21.75	18	36
		EVS1242X1S1F	1077	21.75	18	42

**EVS12X1SND - ONE 1/2 HEIGHT OPEN SHELF & ONE 12" OPEN SHELF LATERAL CABINET**

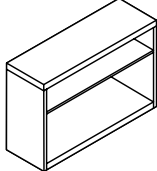

- 1/2 Height Open Shelf.
- Bottom Open Shelf.

	DESCRIPTION	PRODUCT CODE	LIST PRICE	DIMENSIONS/INCHES		
				H	D	W
	One 1/2 Height Open Shelf &	EVS1230X1SND	833	21.75	18	30
	One 12" Open Shelf Lateral Cabinet	EVS1236X1SND	907	21.75	18	36
		EVS1242X1SND	970	21.75	18	42

**EVS12X1S - ONE 1/2 HEIGHT SHELF & ONE 12" SHELF LATERAL CABINET WITH DOORS**

- One 1/2 height storage module with long pull handles.
- Storage cabinet with doors.
- Includes Lock.

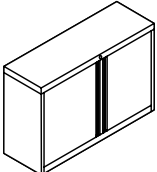
	DESCRIPTION	PRODUCT CODE	LIST PRICE	DIMENSIONS/INCHES		
				H	D	W
	One and 1/2 Height Shelf &	EVS1230X1S	874	21.75	18	30
	One 12" Shelf Lateral Cabinet with Doors	EVS1236X1S	975	21.75	18	36
		EVS1242X1S	1068	21.75	18	42

**EVCUSHION18 - LATERAL SEAT CUSHIONS**

- Cushions will have single stitching at the seams.
- Velcro included for quick attachment to lateral file.
- 1" Cushion will have a rectilinear design on all sides.
- 2" Cushion will have waterfall edges Front and Back.
- Please choose a fabric from the standard cushion textiles on pages 244-246.

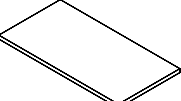
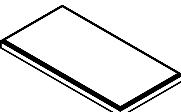
	DESCRIPTION	PRODUCT CODE	LIST PRICE/GRADES																	DIM./INCH			YRDS
			3	4	5	6	7	8	9	10	11	12	13	14	15	16	17	18	19	H	D	W	
	Lateral Seat	EVCUSHION18X30X1	208	237	259	294	342	365	409	480	534	594	718	850	983	1115	1380	1644	1909	1	18	30	1
	Cushions - 1" Thick	EVCUSHION18X36X1	232	261	284	318	367	390	434	504	558	618	742	875	1007	1139	1404	1669	1933	1	18	36	1
		EVCUSHION18X42X1	248	277	300	334	383	405	450	520	574	634	758	891	1023	1155	1420	1684	1949	1	18	42	1
	Lateral Seat	EVCUSHION18X30X2	230	258	281	315	364	387	431	501	556	616	740	872	1005	1137	1402	1666	1931	2	18	30	2
	Cushions - 2" Thick	EVCUSHION18X36X2	256	285	308	342	391	414	458	528	582	643	767	899	1031	1164	1428	1693	1958	2	18	36	2
		EVCUSHION18X42X2	274	303	326	360	409	431	476	546	600	660	784	917	1049	1181	1446	1710	1975	2	18	42	2



**EVT - LATERAL FILE TOPS**

- Note the following abbreviations:  
T = Thermally-Fused Laminate and H = High Pressure Laminate.
- Available in standard Evolve finishes see page 240.

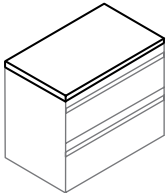
	DESCRIPTION	PRODUCT CODE	LIST PRICE		DIMENSIONS/INCHES		
			Gr1	Gr2	H	D	W
	Lateral File Tops	EVT1830	106	152	1	18	30
		EVT1836	123	173	1	18	36
		EVT1842	145	228	1	18	42
		EVT1860	201	347	1	18	60
		EVT1872	237	391	1	18	72
		EVT1884	332	447	1	18	84
		EVT1890	348	487	1	18	90
		EVT18108	433	600	1	18	108

**EVS12FKIT - 1212 DRAWER CONVERSION KIT**

- Converts an existing box/box/file pedestal into a file/file pedestal.
- Kit includes 1 - 12" high drawer front, 1 - 12" high drawer body, 2 sets of slides and lock bar.
- Specify type of conversion kit, color of front and color of handle. Existing pedestal depth to be retrofitted.
- Must be factory installed.

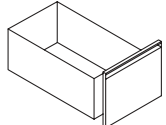
	DESCRIPTION	PRODUCT CODE	LIST PRICE	DIMENSIONS/INCHES		
				H	D	W
	1212 Drawer Conversion Kit	EVS1218FKIT	158	15	18	15
		EVS1223FKIT	158	15	23	15
		EVS1224FKIT	158	15	24	15
		EVS1229FKIT	158	15	29	15
		EVS1230FKIT	158	15	30	15

**EVS12BKIT - 6612 DRAWER CONVERSION KIT**

- Converts an existing file/file pedestal into a box/box/file pedestal.
- Kit includes 2 - 6" high drawer front, 2 - 6" high drawer body, set of slides and lock bar.
- Specify type of conversion kit, color of front and color of handle. Existing pedestal depth to be retrofitted.
- Must be factory installed.

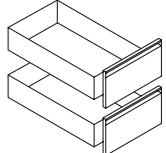
	DESCRIPTION	PRODUCT CODE	LIST PRICE	DIMENSIONS/INCHES		
				H	D	W
	6612 Drawer Conversion Kit	EVS1218BKIT	158	15	18	15
		EVS1223BKIT	158	15	23	15
		EVS1224BKIT	158	15	24	15
		EVS1229BKIT	158	15	29	15
		EVS1230BKIT	158	15	30	15

**EVS12FFKIT - FIXED FRONT DOOR CONVERSION KIT**

- Fixed front drawer conversion with receding door roll out drawer.
- Must indicate position (1,2,3,4,5) of conversion from top to bottom.
- Drawer interiors are finished Black.

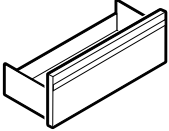
	DESCRIPTION	PRODUCT CODE	LIST PRICE	DIMENSIONS/INCHES		
				H	D	W
	Fixed Front Door Conversion Kit	EVS1230FFKIT	206	13.5	17	30
		EVS1236FFKIT	206	13.5	17	36
		EVS1242FFKIT	206	13.5	17	42

**EVS12RDKIT - RECEDING DOOR WITH FIXED SLOTTED SHELF**

- Receding door and fixed slotted shelf conversion from fixed front drawer.
- Fixed front drawer can be substituted for a roll out drawer in a receding opening at no extra charge at the time of order.
- Add list price to each opening being converted.
- Indicate position (1,2,3,4,5) of conversion from top to bottom.
- Drawer interiors are finished Black.

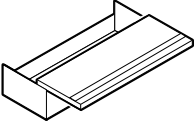
	DESCRIPTION	PRODUCT CODE	LIST PRICE	DIMENSIONS/INCHES		
				H	D	W
	Receding Door with Fixed Slotted Shelf	EVS1230RDKIT	206	9.1	16.5	30
		EVS1236RDKIT	206	9.1	16.5	36
		EVS1242RDKIT	206	9.1	16.5	42

**EVS12BHHKIT - HALF HEIGHT DOOR CONVERSION KIT**

- Receding door and fixed slotted shelf conversion from fixed front drawer.
- Fixed front drawer can be substituted for a roll out drawer in a receding opening at no extra charge at the time of order.
- Add list price to each opening being converted.
- Indicate position (1,2,3,4,5) of conversion from top to bottom.
- Drawer interiors are finished Black.

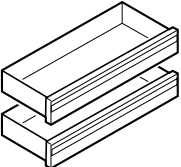
	DESCRIPTION	PRODUCT CODE	LIST PRICE	DIMENSIONS/INCHES		
				H	D	W
	Half Height Door Conversion Kit	EVS1230BHHKIT	196	6.75	17	30
		EVS1236BHHKIT	196	6.75	17	36
		EVS1242BHHKIT	196	6.75	17	42



**EVSCR/SGD-P - 21" HIGH PANEL MOUNTED DOUBLE WALL CABINET**

- Inside dimensions 13"high x 13"deep
- Quality steel construction
- Available in standard Evolve paint finishes
- Tracks for sliding Glass door available in Tungsten only
- Available in Tempered Frosted Glass option only
- Push in Lock, No Keys alike. Cannot be keyed alike.
- **R**-Round legs
- **S**-Square legs
- Panel supported( brackets included)
- Double wall cabinet top not included.

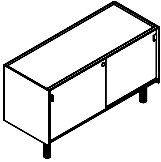
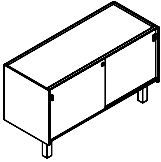
	DESCRIPTION	PRODUCT CODE	LIST PRICE	DIMENSIONS/INCHES		
				H	D	W
	21" High Panel Mounted Double Wall Cabinet - Round Legs	EVSCRGD1330P	588	21	14.7	30
		EVSCRGD1336P	620	21	14.7	36
		EVSCRGD1342P	665	21	14.7	42
		EVSCRGD1348P	708	21	14.7	48
		EVSCRGD1354P	753	21	14.7	54
		EVSCRGD1360P	785	21	14.7	60
	21" High Panel Mounted Double Wall Cabinet - Square Legs	EVSCSGD1330P	588	21	14.7	30
		EVSCSGD1336P	620	21	14.7	36
		EVSCSGD1342P	665	21	14.7	42
		EVSCSGD1348P	708	21	14.7	48
		EVSCSGD1354P	753	21	14.7	54
		EVSCSGD1360P	785	21	14.7	60

**EVSCR/SGD-F - 21" HIGH FREESTANDING DOUBLE WALL CABINET**

- Inside dimensions 13"high x 13"deep
- Quality steel construction
- Available in standard Evolve paint finishes
- Tracks for sliding Glass door available in Tungsten only
- Available in Tempered Frosted Glass option only
- Push in Lock, No Keys alike. Cannot be keyed alike.
- **R**-Round legs
- **S**-Square legs
- Free Standing with Back Wall
- Double wall cabinet top not included.

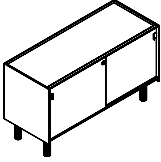
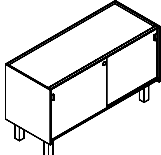
	DESCRIPTION	PRODUCT CODE	LIST PRICE	DIMENSIONS/INCHES		
				H	D	W
	21" High Freestanding Double Wall Cabinet - Round Legs	EVSCRGD1330F	682	21	14.7	30
		EVSCRGD1336F	718	21	14.7	36
		EVSCRGD1342F	768	21	14.7	42
		EVSCRGD1348F	816	21	14.7	48
		EVSCRGD1354F	866	21	14.7	54
		EVSCRGD1360F	902	21	14.7	60
	21" High Freestanding Double Wall Cabinet - Square Legs	EVSCSGD1330F	682	21	14.7	30
		EVSCSGD1336F	718	21	14.7	36
		EVSCSGD1342F	768	21	14.7	42
		EVSCSGD1348F	816	21	14.7	48
		EVSCSGD1354F	866	21	14.7	54
		EVSCSGD1360F	902	21	14.7	60

**EVSDCR/SGD - 21" HIGH BACK TO BACK DOUBLE WALL CABINET**

- Inside dimensions 13"high x 13"deep
- Quality steel construction
- Available in standard Evolve paint finishes
- Tracks for sliding Glass door available in Tungsten only
- Available in Tempered Frosted Glass option only
- Push in Lock, No Keys alike
- **R**-Round legs
- **S**-Square legs
- Back to Back Free Standing (back wall included)
- Back to Back top not included.

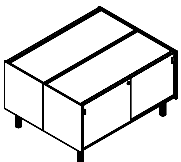
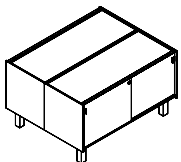
	DESCRIPTION	PRODUCT CODE	LIST PRICE	DIMENSIONS/INCHES		
				H	D	W
	21" High Back to Back Double Wall Cabinet - Round Legs	EVSDCRGD1330	1197	21	29.4	30
		EVSDCRGD1336	1265	21	29.4	36
		EVSDCRGD1342	1360	21	29.4	42
		EVSDCRGD1348	1423	21	29.4	48
		EVSDCRGD1354	1545	21	29.4	54
		EVSDCRGD1360	1613	21	29.4	60
	21" High Back to Back Double Wall Cabinet - Square Legs	EVSDCSGD1330	1197	21	29.4	30
		EVSDCSGD1336	1265	21	29.4	30
		EVSDCSGD1342	1360	21	29.4	30
		EVSDCSGD1348	1423	21	29.4	30
		EVSDCSGD1354	1545	21	29.4	30
		EVSDCSGD1360	1613	21	29.4	30

**EVSCR/SGD-P - 28" HIGH PANEL MOUNTED DOUBLE WALL CABINET**

- Inside dimensions 13"high x 13"deep
- Quality steel construction
- Available in standard Evolve paint finishes
- Tracks for sliding Glass door available in Tungsten only
- Available in Tempered Frosted Glass option only
- Push in Lock, No Keys alike
- **R**-Round legs
- **S**-Square legs
- Panel supported (brackets included)
- Double wall cabinet top not included.

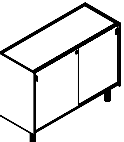
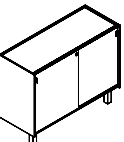
	DESCRIPTION	PRODUCT CODE	LIST PRICE	DIMENSIONS/INCHES		
				H	D	W
	28" High Panel Mounted Double Wall Cabinet - Round Legs	EVSCRGD2230P	777	28	14.7	30
		EVSCRGD2236P	814	28	14.7	36
		EVSCRGD2242P	864	28	14.7	42
		EVSCRGD2248P	911	28	14.7	48
		EVSCRGD2254P	964	28	14.7	54
		EVSCRGD2260P	1004	28	14.7	60
	28" High Panel Mounted Double Wall Cabinet - Square Legs	EVSCSGD2230P	777	28	14.7	30
		EVSCSGD2236P	814	28	14.7	36
		EVSCSGD2242P	864	28	14.7	42
		EVSCSGD2248P	911	28	14.7	48
		EVSCSGD2254P	964	28	14.7	54
		EVSCSGD2260P	1004	28	14.7	60



**EVSCR/SGD-F - 28" HIGH FREESTANDING DOUBLE WALL CABINET**

- Inside dimensions 13"high x 13"deep
- Quality steel construction
- Available in standard Evolve paint finishes
- Tracks for sliding Glass door available in Tungsten only
- Available in Tempered Frosted Glass option only
- Push in Lock, No Keys alike
- **R**-Round legs
- **S**-Square legs
- Free Standing with Back Wall
- Double wall cabinet top not included.

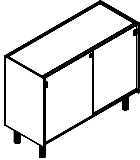
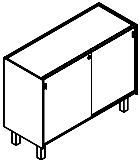
	DESCRIPTION	PRODUCT CODE	LIST PRICE	DIMENSIONS/INCHES		
				H	D	W
	28" High Freestanding Double Wall Cabinet - Round Legs	EVSCRGD2230F	870	28	14.7	30
		EVSCRGD2236F	911	28	14.7	36
		EVSCRGD2242F	971	28	14.7	42
		EVSCRGD2248F	1025	28	14.7	48
		EVSCRGD2254F	1084	28	14.7	54
		EVSCRGD2260F	1125	28	14.7	60
	28" High Freestanding Double Wall Cabinet - Square Legs	EVSCSGD2230F	870	28	14.7	30
		EVSCSGD2236F	911	28	14.7	36
		EVSCSGD2242F	971	28	14.7	42
		EVSCSGD2248F	1025	28	14.7	48
		EVSCSGD2254F	1084	28	14.7	54
		EVSCSGD2260F	1125	28	14.7	60

**EVSDCR/SGD - 28" HIGH BACK TO BACK DOUBLE WALL CABINET**

- Inside dimensions 13"high x 13"deep
- Quality steel construction
- Available in standard Evolve paint finishes
- Tracks for sliding Glass door available in Tungsten only
- Available in Tempered Frosted Glass option only
- Push in Lock, No Keys alike
- **R**-Round legs
- **S**-Square legs
- Back to Back Free Standing (back wall included)
- Back to Back top not included.

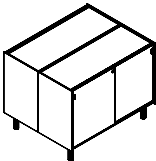
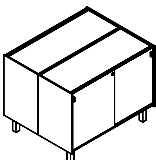
	DESCRIPTION	PRODUCT CODE	LIST PRICE	DIMENSIONS/INCHES		
				H	D	W
	28" High Back to Back Double Wall Cabinet - Round Legs	EVSDCRGD2230	1574	28	29.4	30
		EVSDCRGD2236	1647	28	29.4	36
		EVSDCRGD2242	1761	28	29.4	42
		EVSDCRGD2248	1861	28	29.4	48
		EVSDCRGD2254	1976	28	29.4	54
		EVSDCRGD2260	2049	28	29.4	60
	28" High Back to Back Double Wall Cabinet - Square Legs	EVSDCSGD2230	1574	28	29.4	30
		EVSDCSGD2236	1647	28	29.4	36
		EVSDCSGD2242	1761	28	29.4	42
		EVSDCSGD2248	1861	28	29.4	48
		EVSDCSGD2254	1976	28	29.4	54
		EVSDCSGD2260	2049	28	29.4	60

**DOUBLE WALL CABINET TOP**

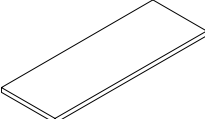
	DESCRIPTION	PRODUCT CODE	LIST PRICE	DIMENSIONS/INCHES		
				H	D	W
	Double Wall Cabinet Top	EVT1430	82	1	14.5	30
		EVT1436	93	1	14.5	36
		EVT1442	106	1	14.5	42
		EVT1448	120	1	14.5	48
		EVT1454	130	1	14.5	54
		EVT1460	145	1	14.5	60

**BACK TO BACK DOUBLE WALL CABINET TOP**

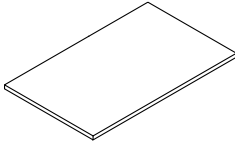
	DESCRIPTION	PRODUCT CODE	LIST PRICE	DIMENSIONS/INCHES		
				H	D	W
	Back to Double Wall Cabinet Top Top	EVT2930	123	1	29.4	30
		EVT2936	146	1	29.4	36
		EVT2942	205	1	29.4	42
		EVT2948	216	1	29.4	48
		EVT2954	237	1	29.4	54
		EVT2960	253	1	29.4	60

**EVS12TXX2B1F - TWELVE SERIES BOX/BOX/FILE STORAGE TOWER**

- This versatile tower can be used freestanding or integrated into a workstation to provide efficient vertical storage and filing, and provides storage for hats and coats.
- Storage tower has 1 adjustable shelf and 1 fixed shelf.
- Tower comes with 3 locks - 1 for the drawers, 1 for the storage door and 1 for the coat locker.
- Coat storage may be specified right or left.
- Full height coat storage is 7" wide with ventilation.
- Locks are keyed alike.

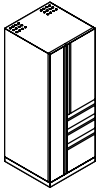
	DESCRIPTION	PRODUCT CODE	LIST PRICE	DIMENSIONS/INCHES		
				H	D	W
	Twelve Series Box/Box File Storage Tower - 50" High	EVS12T502B1FR	2030	50	24	24
		EVS12T502B1FL	2030	50	24	24
	Twelve Series Box/Box File Storage Tower - 54" High	EVS12T542B1FR	2030	54	24	24
		EVS12T542B1FL	2030	54	24	24
	Twelve Series Box/Box/File Storage Tower - 65 7/8" High	EVS12T662B1FR	2122	65.875	24	24
		EVS12T662B1FL	2122	65.875	24	24

Left shown

**EVS12TXX2F - TWELVE SERIES FILE/FILE STORAGE TOWER**

- This versatile tower can be used freestanding or integrated into a workstation to provide efficient vertical storage and filing, and provides storage for hats and coats.
- Storage tower has 1 adjustable shelf and 1 fixed shelf.
- Tower comes with 3 locks - 1 for the drawers, 1 for the storage door and 1 for the coat locker.
- Coat storage may be specified right or left.
- Full height coat storage is 7" wide with ventilation.
- Locks are keyed alike.

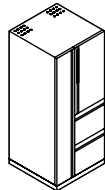
	DESCRIPTION	PRODUCT CODE	LIST PRICE	DIMENSIONS/INCHES		
				H	D	W
	Twelve Series File/File Storage Tower - 50" High	EVS12T502FR	2030	50	24	24
		EVS12T502FL	2030	50	24	24
	Twelve Series File/File Storage Tower - 54" High	EVS12T542FR	2030	54	24	24
		EVS12T542FL	2030	54	24	24
	Twelve Series File/File Storage Tower - 65 7/8" High	EVS12T662FR	2122	65.875	24	24
		EVS12T662FL	2122	65.875	24	24

Left shown



**EVS12TSOXX2BF - TWELVE SERIES SIDE OPENING BOX/BOX/FILE STORAGE TOWER**

- This versatile tower can be used freestanding or integrated into a workstation to provide efficient vertical storage and filing, and provides storage for hats and coats.
- Coat storage may be specified right or left.
- Full height coat storage is 7" wide with ventilation.
- Storage tower has 1 adjustable shelf and 1 fixed shelf.
- Tower comes with 2 locks - 1 for the file drawers and 1 for the coat locker.
- Locks are keyed alike.

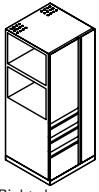
	DESCRIPTION	PRODUCT CODE	LIST PRICE	DIMENSIONS/INCHES		
				H	D	W
	Twelve Series Side Opening	EVS12TS0502BFR	2230	50	24	24
	Box/Box/File Storage Tower - 50" High	EVS12TS0502BFL	2230	50	24	24
	Twelve Series Side Opening	EVS12TS0542B1FR	2243	54	24	24
	Box/Box/File Storage Tower - 54" High	EVS12TS0542B1FL	2243	54	24	24
	Twelve Series Side Opening	EVS12TS0662B1FR	2279	65.875	24	24
	Box/Box/File Storage Tower - 65 7/8" High	EVS12TS0662B1FL	2279	65.875	24	24

Right shown

**EVS12TSOXX2F - TWELVE SERIES SIDE OPENING FILE/FILE STORAGE TOWER**

- This versatile tower can be used freestanding or integrated into a workstation to provide efficient vertical storage and filing, and provides storage for hats and coats.
- Coat storage may be specified right or left.
- Full height coat storage is 7" wide with ventilation.
- Storage tower has 1 adjustable shelf and 1 fixed shelf.
- Tower comes with 2 locks - 1 for the file drawers and 1 for the coat locker.
- Locks are keyed alike.

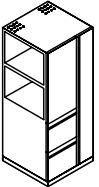

	DESCRIPTION	PRODUCT CODE	LIST PRICE	DIMENSIONS/INCHES		
				H	D	W
	Twelve Series Side Opening	EVS12TS0502FR	2230	50	24	24
	File/File Storage Tower - 50" High	EVS12TS0502FL	2230	50	24	24
	Twelve Series Side Opening	EVS12TS0542FR	2243	54	24	24
	File/File Storage Tower - 54" High	EVS12TS0542FL	2243	54	24	24
	Twelve Series Side Opening	EVS12TS0662FR	2279	65.875	24	24
	File/File Storage Tower - 65 7/8" High	EVS12TS0662FL	2279	65.875	24	24

Right shown

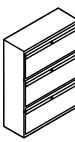
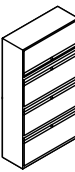

**EVS12F - 12" OPENING LATERAL FILE FIXED FRONT DRAWERS**

- 12" Opening Lateral File.
- Two High: All openings are Fixed Front Drawer.
- Three High: All openings are Fixed Front Drawer.
- Four High: Top drawer is receding with roll-out shelf. Remaining drawers are Fixed Front Drawers.
- Five High: Top 2 drawers are receding door and roll-out shelf. Remaining drawers are Fixed Front Drawers.
- Side-to-side bars and lock included.
- Counterweights must be specified on lateral files with pull out drawers, unless worksurface supporting, ganged together or anchored to the floor or wall.

	DESCRIPTION	PRODUCT CODE	LIST PRICE	DIMENSIONS/INCHES		
				H	D	W
	12" Opening Lateral File - 2 High	EVS123022FWS	907	27.75	18	30
		EVS123622FWS	949	27.75	18	36
		EVS124222FWS	1001	27.75	18	42
	12" Opening Lateral File - 3 High	EVS123033F	1190	40.5	18	30
		EVS123633F	1250	40.5	18	36
		EVS124233F	1323	40.5	18	42
	12" Opening Lateral File - 4 High	EVS123041R3F	1510	54	18	30
		EVS123641R3F	1589	54	18	36
		EVS124241R3F	1684	54	18	42
	12" Opening Lateral File - 5 High	EVS123052R3F	1867	65.88	18	30
		EVS123652R3F	1946	65.88	18	36
		EVS124252R3F	2051	65.88	18	42



**EVS12R1F - 12" RECEDING DOOR AND ROLL-OUT SHELVES**

- 12" Opening Lateral File.
- Two High: Top opening is Receding Door and Roll-Out Shelf. Bottom drawer is Fixed Front Drawer.
- Three High: Top 2 openings are Receding Door and Roll-Out Shelf. Bottom drawer is Fixed Front Drawer.
- Four High: Top 3 openings are Receding Door and Roll-Out Shelf. Bottom drawer is Fixed Front Drawer.
- Five High: Top 4 openings are Receding Door and Roll-Out Shelf. Bottom drawer is Fixed Front Drawer.
- Side-to-side bars and lock included.
- Counterweights must be specified on lateral files with pull out drawers, unless worksurface supporting, ganged together or anchored to the floor or wall.

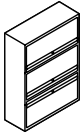
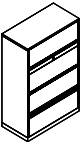
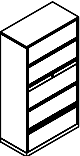
	DESCRIPTION	PRODUCT CODE	LIST PRICE	DIMENSIONS/INCHES		
				H	D	W
	12" Receding Door and Roll-Out Shelves - 2 High	EVS123021R1FWS	896	27.75	18	30
		EVS123621R1FWS	935	27.75	18	36
		EVS124221R1FWS	988	27.75	18	42
	12" Receding Door and Roll-Out Shelves - 3 High	EVS123032R1F	1241	40.5	18	30
		EVS123632R1F	1303	40.5	18	36
		EVS124232R1F	1373	40.5	18	42
	12" Receding Door and Roll-Out Shelves - 4 High	EVS123043R1F	1570	54	18	30
		EVS123643R1F	1660	54	18	36
		EVS124243R1F	1760	54	18	42
	12" Receding Door and Roll-Out Shelves - 5 High	EVS123054R1F	1933	65.88	18	30
		EVS123654R1F	2034	65.88	18	36
		EVS124254R1F	2145	65.88	18	42

**EVS12S - 12" RECEDING DOOR AND FIXED SHELVES**

- 12" Opening Lateral File.
- Two High: All openings are Receding Doors and Fixed Shelves.
- Three High: All openings are Receding Doors and Fixed Shelves.
- Four High: All openings are Receding Doors and Fixed Shelves.
- Five High: All openings are Receding Doors and Fixed Shelves.
- 3 Plate Dividers and Lock are included.
- Counterweights must be specified on lateral files with pull out drawers, unless worksurface supporting, ganged together or anchored to the floor or wall.

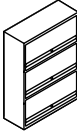
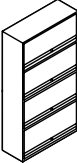
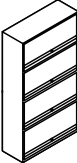
	DESCRIPTION	PRODUCT CODE	LIST PRICE	DIMENSIONS/INCHES		
				H	D	W
	12" Receding Door and Fixed Shelves - 2 High	EVS123022SWS	906	27.75	18	30
		EVS123622SWS	949	27.75	18	36
		EVS124222SWS	1001	27.75	18	42
	12" Receding Door and Fixed Shelves - 3 High	EVS123033S	1190	40.5	18	30
		EVS123633S	1250	40.5	18	36
		EVS124233S	1324	40.5	18	42
	12" Receding Door and Fixed Shelves - 4 High	EVS123044S	1510	54	18	30
		EVS123644S	1591	54	18	36
		EVS124244S	1684	54	18	42
	12" Receding Door and Fixed Shelves - 5 High	EVS123055S	1867	65.88	18	30
		EVS123655S	1945	65.88	18	36
		EVS124255S	2052	65.88	18	42



**EVS121B3F - 12" OPENING LATERAL FILE WITH 1 "B" - BINDER OPENING, RECEDING DOOR AND 3 FIXED FRONT DRAWERS**

- 12" Opening Lateral File.
- Four High: Top opening is "B" size with Receding Door and Fixed Shelf. Remaining 3 drawers are Fixed Front Drawers.
- Five High: Top opening is "B" size with Receding Door and Fixed Shelf. Remaining 4 drawers are Fixed Front Drawers.
- Lock is included.
- Counterweights must be specified on lateral files with pull out drawers, unless worksurface supporting, ganged together or anchored to the floor or wall.

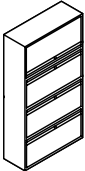
	DESCRIPTION	PRODUCT CODE	LIST PRICE	DIMENSIONS/INCHES		
				H	D	W
	12" Opening Lateral File with 1 "B" Opening, Receding Door and 3 Fixed Shelves - 4 High	EVS123041B3F	1922	54	18	30
		EVS123641B3F	1996	54	18	36
		EVS124241B3F	2072	54	18	42
	12" Opening Lateral File with 1 "B" Opening, Receding Door and 4 Fixed Shelves - 5 High 4 High Shown	EVS123051B1R3F	2314	65.88	18	30
		EVS123651B1R3F	2438	65.88	18	36
		EVS124251B1R3F	2576	65.88	18	42

**EVT - LATERAL FILE TOPS**

- Note the following abbreviations:
- H = High Pressure Laminate
- T = Thermally-Fused Laminate
- Available in standard Evolve finishes see page 240.

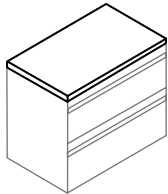
	DESCRIPTION	PRODUCT CODE	LIST PRICE		DIMENSIONS/INCHES		
			LP	HP	H	D	W
	Lateral File Tops	EVT1830	106	152	1	18	30
		EVT1836	123	173	1	18	36
		EVT1842	145	228	1	18	42
		EVT1860	201	347	1	18	60
		EVT1872	237	391	1	18	72
		EVT1884	332	447	1	18	84
		EVT1890	348	487	1	18	90
		EVT18108	433	600	1	18	108

**EVS12M502S2F - 12" OPENING MULTI STORAGE UNIT**

- 2 lateral file drawers and storage with hinged doors.
- Lock is included.

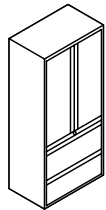
	DESCRIPTION	PRODUCT CODE	LIST PRICE	DIMENSIONS/INCHES			
				H	D	W	
 5 High (Lateral) Shown	12" Opening Multi Storage Unit - 4 High (50" High)	EVS1230M502S2F	1907	50	18	30	
		EVS1236M502S2F	2040	50	18	36	
		EVS1242M502S2F	2198	50	18	42	
	12" Opening Multi Storage Unit - 4 High (54" High)	EVS1230M542S2F	2001	2001	54	18	30
		EVS1236M542S2F	2140	2140	54	18	36
		EVS1242M542S2F	2221	2221	54	18	42
	12" Opening Multi Storage Unit - 5 High (2 Lateral)	EVS1230M662S2F	2226	2226	65.88	18	30
		EVS1236M662S2F	2393	2393	65.88	18	36
		EVS1242M662S2F	2559	2559	65.88	18	42
	12" Opening Multi Storage Unit - 5 High (3 Lateral)	EVS1230M662S3F	2213	2213	65.88	18	30
		EVS1236M662S3F	2393	2393	65.88	18	36
		EVS1242M662S3F	2581	2581	65.88	18	42

**EVS12SFSND - OPEN STORAGE CABINET**

- Storage Cabinet with no doors.
- 2SIND - 27 3/4" high with 1 shelf.
- 3SIND - 40 1/2" high with 2 shelves.
- 4SIND - 54" high with 3 shelves.
- 5SIND - 65 7/8" high with 4 shelves.
- Shelves are height adjustable.

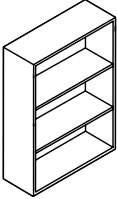
	DESCRIPTION	PRODUCT CODE	LIST PRICE	DIMENSIONS/INCHES		
				H	D	W
 3 High Shown	Open Storage Cabinet - 2 High Worksurface Supporting	EVS1230SF2SND	709	27.75	18	30
		EVS1236SF2SND	822	27.75	18	36
		EVS1242SF2SND	859	27.75	18	42
	Open Storage Cabinet - 3 High	EVS1230SF3SND	793	40.5	18	30
		EVS1236SF3SND	859	40.5	18	36
		EVS1242SF3SND	963	40.5	18	42
	Open Storage Cabinet - 4 High	EVS1230SF4SND	950	54	18	30
		EVS1236SF4SND	1012	54	18	36
		EVS1242SF4SND	1074	54	18	42
	Open Storage Cabinet - 5 High	EVS1230SF5SND	1095	65.88	18	30
		EVS1236SF5SND	1160	65.88	18	36
		EVS1242SF5SND	1208	65.88	18	42

**EVS12S - 12" STORAGE CABINET WITH HINGED DOOR**

- 2S - 27 3/4" high with 1 shelf.
- 3S - 40 1/2" high with 2 shelves.
- 4S - 54" high with 3 shelves.
- 5S - 65 7/8" high with 4 shelves.
- 5W - 65 7/8" high wardrobe cabinet with a coat rod and 4 half shelves in the 36" and 42" wide units. 30" wide units have a coat rod and 4 coat hooks.
- Shelves are height adjustable.
- Lock is included.

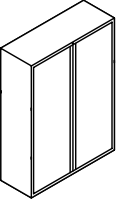
	DESCRIPTION	PRODUCT CODE	LIST PRICE	DIMENSIONS/INCHES		
				H	D	W
 5 High Shown	12" Storage Cabinet with Hinged Door - 2 High (WS Supporting)	EVS12302SWS	744	27.75	18	30
		EVS12362SWS	829	27.75	18	36
		EVS12422SWS	903	27.75	18	42
	12" Storage Cabinet with Hinged Door - 3 High	EVS12303S	920	40.5	18	30
		EVS12363S	1042	40.5	18	36
		EVS12423S	1153	40.5	18	42
	12" Storage Cabinet with Hinged Door - 4 High	EVS12304S	1110	54	18	30
		EVS12364S	1240	54	18	36
		EVS12424S	1373	54	18	42
	12" Storage Cabinet with Hinged Door - 5 High	EVS12305S	1252	65.88	18	30
		EVS12365S	1404	65.88	18	36
		EVS12425S	1556	65.88	18	42
	12" Storage Cabinet with Hinged Door - 5 High Wardrobe	EVS12305W	1258	65.88	18	30
		EVS12365W	1431	65.88	18	36
		EVS12425W	1573	65.88	18	42



**ALL EVOLVE LATERAL FILES FEATURE**

- Looped full pull.
- Side-to-side file bars and leveling glides included.
- Lock included.
- Worksurface supporting
- Freestanding
- Counterweights must be specified on lateral files with pull out drawers, unless worksurface supporting, ganged together or anchored to the floor or wall.

**EV92\_\_P-2F1H - TWO-HIGH LATERAL FILE**

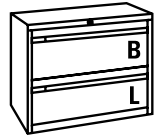

DESCRIPTION	PRODUCT CODE	LIST PRICE	DIMENSIONS/INCHES		
			H	D	W
Two-High Lateral File	EV9230P-2F1H	699	27.625	18	30
Two fixed front drawers	EV9236P-2F1H	730	27.625	18	36
	EV9242P-2F1H	809	27.625	18	42

**EV92\_\_P-3F1H - THREE-HIGH LATERAL FILE**

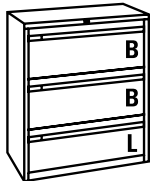

DESCRIPTION	PRODUCT CODE	LIST PRICE	DIMENSIONS/INCHES		
			H	D	W
Three-High Lateral File	EV9230P-3F1H	878	40.5	18	30
Three fixed front drawers	EV9236P-3F1H	972	40.5	18	36
	EV9242P-3F1H	1056	40.5	18	42

**EV92\_\_P-4F1H - FOUR-HIGH LATERAL FILE**

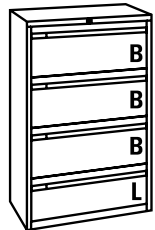

DESCRIPTION	PRODUCT CODE	LIST PRICE	DIMENSIONS/INCHES		
			H	D	W
Four-High Lateral File	EV9230P-4F1H	1156	54	18	30
Four fixed front drawers	EV9236P-4F1H	1220	54	18	36
	EV9242P-4F1H	1366	54	18	42

**EV92\_\_P-5F1H - FIVE-HIGH LATERAL FILE**

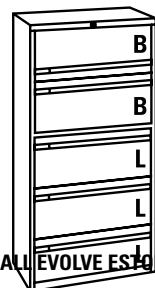

DESCRIPTION	PRODUCT CODE	LIST PRICE	DIMENSIONS/INCHES		
			H	D	W
Five-High Lateral File	EV9230P-5F1H	1463	65.25	18	30
Four fixed front drawers	EV9236P-5F1H	1537	65.25	18	36
Top drawer opening with receding door and roll-out shelf.	EV9242P-5F1H	1702	65.25	18	42

**ALL EVOLVE ESTOR STORAGE FEATURES**

- Pencil Tray
- Base elect pass through
- 4 mounting brackets and instructions
- Note: Handedness is determined by file side.

**EVS3054MDPL/R - FOUR HIGH MULTI-STORAGE PASS THROUGH CABINET**

- Four High Multi Storage Pass Through Cabinet with 1 combination lateral file at the bottom.
- One closed storage compartment with one adjustable shelf.
- Base pass through for electrical
- Cabinet comes with 2 locks, 1 for combination lateral and 1 for storage cabinet.
- Handedness is determined by side with two (2) box drawers.
- Locks are keyed alike.

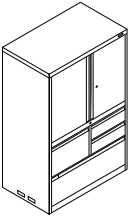
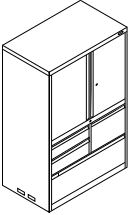
	DESCRIPTION	PRODUCT CODE	LIST PRICE	DIMENSIONS/INCHES		
				H	D	W
	Four High Multi-Storage Pass Through Cabinet - Left	EVS3054MDPL	2793	54	18	30
	Four High Multi-Storage Pass Through Cabinet - Right	EVS3054MDPR	2793	54	18	30

**EVS3054MDPOL/R - FOUR HIGH MULTI-STORAGE PASS THROUGH CABINET**

- Four High Multi Storage Pass Through Cabinet with 1 combination lateral file at the bottom.
- One closed storage compartment with 1 adjustable shelf and 1 open bookcase with 1 adjustable shelf at the top.
- Cabinet comes with 2 locks, 1 for combination lateral and 1 for storage cabinet.
- Handedness is determined by side with two (2) box drawers.
- Locks are keyed alike.

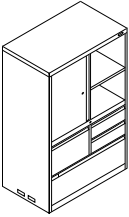
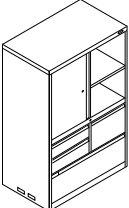
	DESCRIPTION	PRODUCT CODE	LIST PRICE	DIMENSIONS/INCHES		
				H	D	W
	Four High Multi-Storage Pass Through Cabinet - Left	EVS3054MDPOL	2726	54	18	30
	Four High Multi-Storage Pass Through Cabinet - Right	EVS3054MDPOR	2726	54	18	30



**EVSXX54M12L - FOUR HIGH MULTI-STORAGE PASS THROUGH CABINET**

- Four High Multi Storage Pass Through Cabinet with 2 lateral files at the bottom.
- One closed storage compartment with 1 adjustable shelf
- Base pass through for electrical.
- Cabinet comes with 2 locks, 1 for lateral and 1 for storage cabinet.
- Locks are keyed alike.

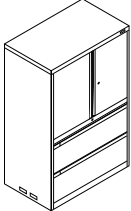
	DESCRIPTION	PRODUCT CODE	LIST PRICE	DIMENSIONS/INCHES		
				H	D	W
	Four High Multi-Storage Pass Through Cabinet	EVS3054M12L	2793	54	18	30
		EVS3654M12L	3068	54	18	36

**EVSXX54M12LOL/R - FOUR HIGH MULTI-STORAGE PASS THROUGH CABINET**

- Four High Multi Storage Pass Through Cabinet with 2 lateral files at the bottom.
- One closed storage compartment with 1 adjustable shelf and 1 open bookcase with one adjustable shelf.
- Cabinet comes with 2 locks, 1 for lateral and 1 for storage cabinet.
- Handedness is determined by side with open shelves.
- Locks are keyed alike.

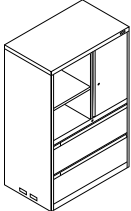
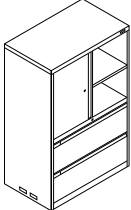
	DESCRIPTION	PRODUCT CODE	LIST PRICE	DIMENSIONS/INCHES		
				H	D	W
	Four High Multi-Storage Pass Through Cabinet - Left	EVS3054M12LOL	2726	54	18	30
		EVS3654M12LOL	3001	54	18	36
	Four High Multi-Storage Pass Through Cabinet - Right	EVS3054M12LOR	2726	54	18	30
		EVS3654M12LOR	3001	54	18	36



**EVS3654MDPL/R - FOUR HIGH MULTI-STORAGE PASS THROUGH CABINET**

- Four High Multi Storage Pass Through Cabinet with 1 combination lateral at the bottom.
- A closed storage cabinet with 1 adjustable shelf
- 6" wardrobe storage
- Cabinet comes with 3 locks, 1 for combination lateral and 1 for storage cabinet and 1 for wardrobe.
- Handedness is determined by wardrobe side.
- Locks are keyed alike.

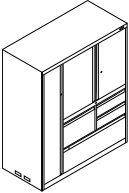
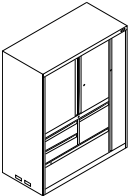
	DESCRIPTION	PRODUCT CODE	LIST PRICE	DIMENSIONS/INCHES		
				H	D	W
	Four High Multi-Storage Pass Through Cabinet - Left	EVS3654MDPL	3068	54	18	36
	Four High Multi-Storage Pass Through Cabinet - Right	EVS3654MDPR	3068	54	18	36

**EVS3654MDPQRL/LR - FOUR HIGH MULTI-STORAGE PASS THROUGH CABINET**

- Four High Multi Storage Pass Through Cabinet with 1 combination lateral at the bottom.
- One closed storage cabinet with 1 adjustable shelf
- One open bookcase with 1 adjustable shelf
- 6" wardrobe storage
- Cabinet comes with 3 locks, 1 for combination lateral and 1 for storage cabinet and 1 for wardrobe.
- Handedness is determined by wardrobe side.
- Locks are keyed alike.

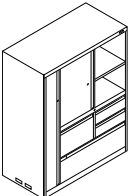
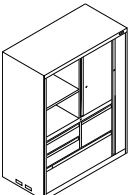
	DESCRIPTION	PRODUCT CODE	LIST PRICE	DIMENSIONS/INCHES		
				H	D	W
	Four High Multi-Storage Pass Through Cabinet - Left	EVS3654MDPQRL	3001	54	18	36
	Four High Multi-Storage Pass Through Cabinet - Right	EVS3654MDPQLR	3001	54	18	36



**EVS3654M12LL/R - FOUR HIGH MULTI-STORAGE PASS THROUGH CABINET**

- Four High Multi Storage Pass Through Cabinet with 2 laterals at the bottom
- One closed storage cabinet with 1 adjustable shelf at the top
- 6" wardrobe storage
- Cabinet comes with 3 locks, 1 for lateral and 1 for storage cabinet and 1 for wardrobe.
- Handedness is determined by wardrobe side.
- Locks are keyed alike.

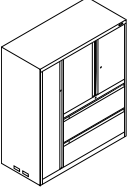
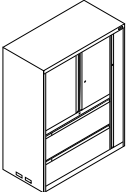
	DESCRIPTION	PRODUCT CODE	LIST PRICE	DIMENSIONS/INCHES		
				H	D	W
	Four High Multi-Storage Pass Through Cabinet - Left	EVS3654M12LL	3068	54	18	36
	Four High Multi-Storage Pass Through Cabinet - Right	EVS3654M12LR	3068	54	18	36

**EVS3654M12LORL/LR - FOUR HIGH MULTI-STORAGE PASS THROUGH CABINET**

- Four High Multi Storage Pass Through Cabinet with 2 laterals at the bottom
- One closed storage cabinet with 1 adjustable shelf and 1 open bookcase with 1 adjustable shelf
- 6" wardrobe storage
- Cabinet comes with 3 locks, 1 for lateral and 1 for storage cabinet and 1 for wardrobe.
- Handedness is determined by wardrobe side.
- Locks are keyed alike.

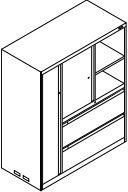
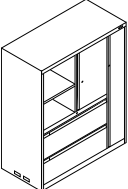
	DESCRIPTION	PRODUCT CODE	LIST PRICE	DIMENSIONS/INCHES		
				H	D	W
	Four High Multi-Storage Pass Through Cabinet - Left	EVS3654M12LORL	3001	54	18	36
	Four High Multi-Storage Pass Through Cabinet - Right	EVS3654M12LORL	3001	54	18	36

**EVAOMBE - MAGNETIC WHITEBOARD FOR ESTOR CABINET**

- Provides a writing surface within a work area.
- Use erasable whiteboard markers only.
- Mounts on back of estor cabinets, above worksurface.

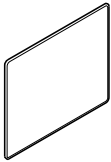
	DESCRIPTION	PRODUCT CODE	LIST PRICE	DIMENSIONS/INCHES		
				H	W	D
	Magnetic Whiteboard for eStor - 30"	EVAOMBE30	314	28	23	
	Magnetic Whiteboard for eStor - 36"	EVAOMBE36	381	34	23	

**92-BHHD - HALF HEIGHT DRAWERS**

- Half height drawers. For 30", 36" or 42" "B" opening, specify 92P-BHHD\_. For 30", 36" or 42" "L" opening, specify 92P-LHHD\_. One pair. Must be factory installed.\*

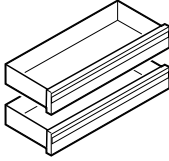
	DESCRIPTION	PRODUCT CODE	LIST PRICE	DIMENSIONS/INCHES		
				H	D	W
	Half Height Drawers "B" Openings	92P-BHHD30	267			30
		92P-BHHD36	286			36
		92P-BHHD42	306			42
	Half Height Drawers "L" Openings	92P-LHHD30	267			30
		92P-LHHD36	286			36
		92P-LHHD42	306			42

**ERRC/EFSL - RECEDING DOOR CONVERSION**

- Receding door and roll-out shelf conversion in "B" or "L" openings from a fixed front drawer.\* (Add list price to each opening being converted at time of order.) Must be factory installed.
- Receding door and fixed slotted shelf conversion in "B" or "L" openings from a fixed front drawer.\* (Add list price to each opening being converted at time of order.) Must be factory installed.

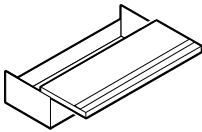
	DESCRIPTION	PRODUCT CODE	LIST PRICE	DIMENSIONS/INCHES		
				H	D	W
	Receding Door Conversion	ERRC30	58			30
	Roll-Out Shelf Conversion	ERRC36	58			36
		ERRC42	58			42
	Receding Door Conversion	EFSL30	58			30
	Fixed Slotted Shelf Conversion	EFSL36	58			36
		EFSL42	58			42

**EFFD - FIXED DRAWER CONVERSION**

- Fixed front drawer conversion in "B" of "L" openings from receding door and roll-out shelf. (No charge for conversion at time of order.) Must be factory installed.
- Note: Fixed shelf cannot be substituted for a roll-out shelf in any position for receding opening. (No charge for conversion at time of order.)
- Please specify all substitutions and options.
- Contact Evolve Customer Service for specific options.

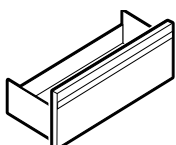
	DESCRIPTION	PRODUCT CODE	LIST PRICE	DIMENSIONS/INCHES		
				H	D	W
	Fixed Drawer Conversion	EFFD30				30
		EFFD36				36
		EFFD42				42



**92PPS - POSTING SHELF**

- Posting shelf. Available in five drawer high cabinets. Factory installed between second and third openings.
- Please specify all substitutions and options.

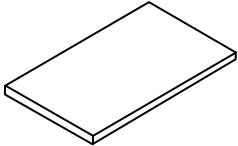
	DESCRIPTION	PRODUCT CODE	LIST PRICE	DIMENSIONS/INCHES		
				H	D	W
	Posting Shelf	92PPS30	163			30
		92PPS36	190			36
		92PPS42	211			42

**EVSEDPS - EDP ADAPTER**

- Not recommended for use in receding front drawers.
- "B" opening only.
- Black only.

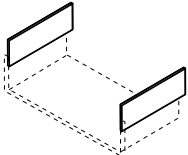
	DESCRIPTION	PRODUCT CODE	LIST PRICE	DIMENSIONS/INCHES		
				H	D	W
	EDP Adapter	EVSEDPS	35		3	16.5

**EVSHFB - HANGING FILE BARS**

- Used in lateral files only.
- Available in black only.

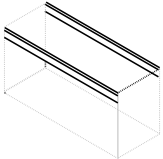
	DESCRIPTION	PRODUCT CODE	LIST PRICE	DIMENSIONS/INCHES		
				H	D	W
	Hanging File Bars	EVSHFB30	34			30
		EVSHFB36	34			36
		EVSHFB42	34			42

**EVSFBB - FRONT-TO-BACK BARS**

- Cross file bars.
- Used in lateral files only.
- Available in grey only.
- Shipped in pairs.

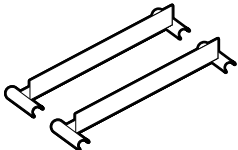
	DESCRIPTION	PRODUCT CODE	LIST PRICE	DIMENSIONS/INCHES		
				H	D	W
	Hanging File Bars	EVSFBB	18			12.25

**EVSLAB - LEGAL-TO-LETTER ADAPTER**

- Used in lateral files only.
- Available in black only.

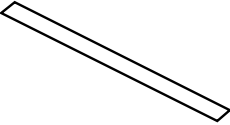
	DESCRIPTION	PRODUCT CODE	LIST PRICE	DIMENSIONS/INCHES		
				H	D	W
	Legal-to-Letter Adapter	EVSLAB30	18			30
		EVSLAB36	18			36
		EVSLAB42	18			42

**EVS\_PD - DIVIDER PLATES**

- Used in full-height shelves and drawers.
- Can be used with EVSOF16 series overheads. See page 191 for specific models.
- Three plates per package.
- Used in lateral files only.
- Available in Grey paint only.

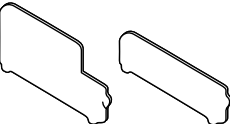
	DESCRIPTION	PRODUCT CODE	LIST PRICE	DIMENSIONS/INCHES		
				H	D	W
	Divider Plates - Half Height Divider	EVSHPD03	37	4		13
	Divider Plates - Full Height Divider	EVSFDP03	37	7		13

**EVAPDIV - PEDESTAL DIVIDER PLATES**

- Priced and shipped individually.

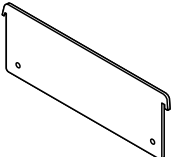
	DESCRIPTION	PRODUCT CODE	LIST PRICE	DIMENSIONS/INCHES		
				H	D	W
	Pedestal Divider Plates	EVAPDIV	21	4		12



**EVSCWB - COUNTERWEIGHT BALANCE**

- Recommended for use in all laterals and freestanding pedestals.
- Black only.
- Must be factory installed.
- Counter weights now designed to accommodate height and width of storage pieces. Please note revised product codes.

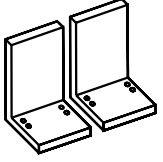
	DESCRIPTION	PRODUCT CODE	LIST PRICE	DIMENSIONS/INCHES		
				H	D	W
	Counterweight Balance - 1.5 High	EVSCWB301XH	330			30
		EVSCWB361XH	276			36
		EVSCWB421XH	372			42
	Counterweight Balance - 2 High	EVSCWB302H	293			30
		EVSCWB362H	301			36
		EVSCWB422H	301			42
	Counterweight Balance - 3 High	EVSCWB303H	283			30
		EVSCWB363H	293			36
		EVSCWB423H	301			42
	Counterweight Balance - 4 High	EVSCWB304H	171			30
		EVSCWB364H	190			36
		EVSCWB424H	198			42
	Counterweight Balance - 5 High	EVSCWB305H	171			30
		EVSCWB365H	190			36
		EVSCWB425H	198			42
	Counterweight Balance - Ped Field Installed	EVSCWPED	82			
	Counterweight Balance - Ped Factory Installed	EVSCWPEDF	151			

**EVS\_\_ - ADDITIONAL KEY**

	DESCRIPTION	PRODUCT CODE	LIST PRICE	DIMENSIONS/INCHES		
				H	D	W
	AK - Additional Key (specify at time of order)	EVSAK92	9			
	EK - Extra Key for existing cabinets (specify at time of order)	EVSEK92	9			
	LOCKKEY - Core and Key	EVLOCKKEY	31			

**EVSLK - LOCK FOR OVERHEAD FLIPPER DOOR STORAGE UNIT**

	DESCRIPTION	PRODUCT CODE	LIST PRICE	DIMENSIONS/INCHES		
				H	D	W
	Lock for Overhead Flipper Door Storage Unit	EVSLK12	39			

SO#		PO#		TAG#		DATE			
KEY#	SETS REQ'D	KEY#	SETS REQ'D	KEY#	SETS REQ'D	KEY#	SETS REQ'D	KEY#	SETS REQ'D
401		431		461		491		521	
402		432		462		492		522	
403		433		463		493		523	
404		434		464		494		524	
405		435		465		495		525	
406		436		466		496		526	
407		437		467		497		527	
408		438		468		498		528	
409		439		469		499		529	
410		440		470		500		530	
411		441		471		501		531	
412		442		472		502		532	
413		443		473		503		533	
414		444		474		504		534	
415		445		475		505		535	
416		446		476		506		536	
417		447		477		507		537	
418		448		478		508		538	
419		449		479		509		539	
420		450		480		510		540	
421		451		481		511		541	
422		452		482		512		542	
423		453		483		513		543	
424		454		484		514		544	
425		455		485		515		545	
426		456		486		516		546	
427		457		487		517		547	
428		458		488		518		548	
429		459		489		519		549	
430		460		490		520		550	

401 - 430 =	431 - 460 =	461 - 490 =	491 - 520 =	521 - 550 =
-------------	-------------	-------------	-------------	-------------

Total:

NOTE : If Key Alike Instructions are not submitted to EVOLVE with the Customer's Purchase Order, all components will be keyed randomly.



accessories



**EVATB - TACK BOARD**

- Provide a tackable surface for notes and memos in a work area.
- Includes two pairs of panel-mounting brackets.
- Only fabric must be specified.
- 17" to be installed under EVSOF13 or EVSOF16
- 21" specified for use under overhead shelf or storage bin.
- 24" for use without any overheads.
- All tackboards are 0.25" in thickness.

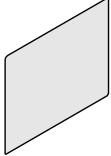
	DESCRIPTION	PRODUCT CODE	LIST PRICE		DIMENSIONS/INCHES		
			Gr1	Gr2	H	W	D
	Tack Board - 17" High	EVATB1730	204	211	17	30	0.25
		EVATB1736	233	239	17	36	0.25
		EVATB1742	265	273	17	42	0.25
		EVATB1748	296	304	17	48	0.25
		EVATB1754	328	338	17	54	0.25
		EVATB1760	358	370	17	60	0.25
	Tack Board - 21" High	EVATB2124	188	195	21	24	0.25
		EVATB2130	204	212	21	30	0.25
		EVATB2136	233	239	21	36	0.25
		EVATB2142	265	275	21	42	0.25
EVATB2148		298	307	21	48	0.25	
EVATB2154		327	340	21	54	0.25	
Tack Board - 24" High	EVATB2160	358	373	21	60	0.25	
	EVATB2430	204	213	24	30	0.25	
	EVATB2436	233	242	24	36	0.25	
	EVATB2442	265	276	24	42	0.25	
	EVATB2448	298	308	24	48	0.25	
	EVATB2454	327	341	24	54	0.25	
	EVATB2460	358	373	24	60	0.25	

**EVAWB - WHITE MARKER BOARD**

- Provides a writing surface within a work area.
- Includes two pairs of panel-mounting brackets.
- 21" specified for use under overhead shelf or storage bin.
- 24" for use without any overheads.

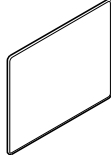
	DESCRIPTION	PRODUCT CODE	LIST PRICE		DIMENSIONS/INCHES		
					H	W	D
	White Marker Board - 21" High	EVAWB2130	218		21	30	
		EVAWB2136	246		21	36	
		EVAWB2142	277		21	42	
		EVAWB2148	322		21	48	
	White Marker Board - 24" High	EVAWB2430	218		24	30	
EVAWB2436		246		24	36		
EVAWB2442		277		24	42		
EVAWB2448		322		24	48		

**EVAMT - MARKER TRAY**

- Provides a tray for storage of markers, erasers, etc.
- Attaches to the bottom of the White Marker Board.
- Available in chrome only.

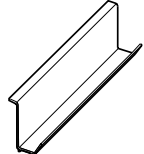
	DESCRIPTION	PRODUCT CODE	LIST PRICE		DIMENSIONS/INCHES		
					H	W	D
	Marker Tray	EVAMT12	12			12	



**EVALB2 - LOAD BAR - TOP**

- Enables accessory items to be hung from a panel.
- Includes end caps and mounting brackets.
- Can be panel mounted.
- Can connect to EVALB2-2 and/or EVALB2-3 Load Bars to create a multi-level load bar or "Slat Wall"
- Note: can be used on its own.
- Available in standard and premium paint selections. See Textiles and Finishes (page 240) for complete offerings and conditions.

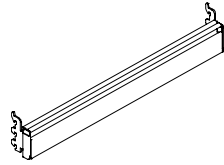

DESCRIPTION	PRODUCT CODE	LIST PRICE	DIMENSIONS/INCHES		
			H	W	D
Load Bar - Top	EVALB224	83	2.25	24	1
	EVALB230	88	2.25	30	1
	EVALB236	94	2.25	36	1
	EVALB242	99	2.25	42	1
	EVALB248	102	2.25	48	1
	EVALB254	106	2.25	54	1
	EVALB260	109	2.25	60	1

**EVALB2-2 - LOAD BAR - MIDDLE**

- Enables accessory items to be hung from a panel.
- Includes end caps and is to be used in conjunction with the Load Bar - Top (EVALB2). Mounting brackets NOT included.
- Can be panel mounted.
- Connects between EVALB2 and EVALB2-3 Load Bars to create a multi-level load bar or "Slat Wall"
- Note: Needs to be used in conjunction with both EVALB2 (as noted above) and EVALB2-3. Multiples of EVALB2-2 can be joined, one below the other, to create a "Slat Wall"

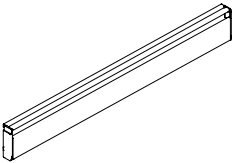

DESCRIPTION	PRODUCT CODE	LIST PRICE	DIMENSIONS/INCHES		
			H	W	D
Load Bar - Middle	EVALB2-224	59	2.25	24	1
	EVALB2-230	62	2.25	30	1
	EVALB2-236	66	2.25	36	1
	EVALB2-242	70	2.25	42	1
	EVALB2-248	74	2.25	48	1
	EVALB2-254	81	2.25	54	1
	EVALB2-260	84	2.25	60	1

**EVALB2-3 - LOAD BAR - BOTTOM**

- Enables accessory items to be hung from a panel.
- Includes end caps and mounting brackets.
- Can be panel mounted.
- Connects between EVALB2-2 and EVALB2-3 Load Bars to create a multi-level load bar or "Slat Wall"
- Note: Needs to be used in conjunction with an EVALB2 or a combination of EVALB2 and EVALB2-2

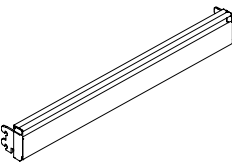

DESCRIPTION	PRODUCT CODE	LIST PRICE	DIMENSIONS/INCHES		
			H	W	D
Load Bar - Bottom	EVALB2-324	81	2.25	24	1
	EVALB2-330	84	2.25	30	1
	EVALB2-336	88	2.25	36	1
	EVALB2-342	94	2.25	42	1
	EVALB2-348	100	2.25	48	1
	EVALB2-354	104	2.25	54	1
	EVALB2-360	107	2.25	60	1

**EVALB - LOAD BAR**

- Enables accessory items to be hung from a panel.
- Includes end caps and mounting brackets.
- Can be panel or wall mounted.
- Must specify finish.
- Attachment slot dimensions = 0.115" W x 0.240" H.
- Slatwall mounted moitor arms will NOT hang on EVALB - load bar.

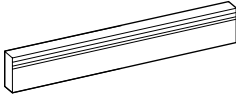
DESCRIPTION	PRODUCT CODE	LIST PRICE	DIMENSIONS/INCHES		
			H	W	D
 <p>Load Bar</p>	EVALB24	105	2.25	24	1
	EVALB30	116	2.25	30	1
	EVALB36	127	2.25	36	1
	EVALB42	147	2.25	42	1
	EVALB48	170	2.25	48	1
	EVALB54	181	2.25	54	1
	EVALB60	195	2.25	60	1

**EVABB01 - BINDER BIN**

- Must be ordered in conjunction with a load bar option.
- Can be used with slat wall module.
- Available in standard and premium paint selections. See Textiles and Finishes (page 240) for a complete list of offerings and conditions.

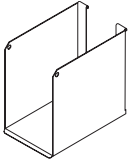
DESCRIPTION	PRODUCT CODE	LIST PRICE	DIMENSIONS/INCHES		
			H	W	D
 <p>Binder Bin</p>	EVABB01	53	9	4	10.25

**EVALT01 - LETTER TRAY**

- Must be ordered in conjunction with a load bar option.
- Can be used with slat wall module.
- Available in standard and premium paint selections. See Textiles and Finishes (page 240) for a complete list of offerings and conditions.

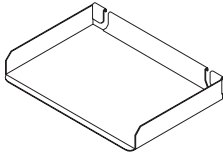
DESCRIPTION	PRODUCT CODE	LIST PRICE	DIMENSIONS/INCHES		
			H	W	D
 <p>Letter Tray</p>	EVALT01	42	2	13.5	9.25

**EVALT02 - LEGAL TRAY**

- Must be ordered in conjunction with a load bar option.
- Can be used with slat wall module.
- Available in standard and premium paint selections. See Textiles and Finishes (page 240) for a complete list of offerings and conditions.

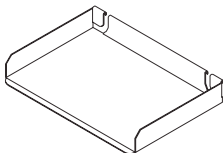
DESCRIPTION	PRODUCT CODE	LIST PRICE	DIMENSIONS/INCHES		
			H	W	D
 <p>Legal Tray</p>	EVALT02	48	1.75	14.7	8.75



**EVASS01 - SLANT SORTER**

- Must be ordered in conjunction with a load bar option.
- Can be used with slat wall module.
- Available in standard and premium paint selections. See Textiles and Finishes (page 240) for a complete list of offerings and conditions.

DESCRIPTION	PRODUCT CODE	LIST PRICE	DIMENSIONS/INCHES		
			H	W	D
Slant Sorter	EVASS01L	33	9.5	5	10.25
	EVASS01R	33	9.5	5	10.25

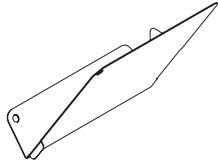

**EVAMB01 - MEDIA BIN**

- Must be ordered in conjunction with a load bar option.
- Can be used with slat wall module.
- Available in standard and premium paint selections. See Textiles and Finishes (page 240) for a complete list of offerings and conditions.

DESCRIPTION	PRODUCT CODE	LIST PRICE	DIMENSIONS/INCHES		
			H	W	D
Media Bin	EVAMB01	42	3	5.75	5.25

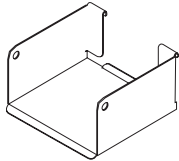

**EVAUT01 - UTILITY TRAY**

- Must be ordered in conjunction with a load bar option.
- Can be used with slat wall module.
- Available in standard and premium paint selections. See Textiles and Finishes (page 240) for a complete list of offerings and conditions.

DESCRIPTION	PRODUCT CODE	LIST PRICE	DIMENSIONS/INCHES		
			H	W	D
Utility Tray	EVAUT01	28	1	8.5	3.75

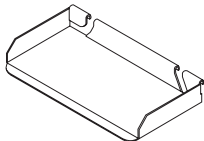

**EVAFS01 - FLIP SORTER**

- Must be ordered in conjunction with a load bar option.
- Can be used with slat wall module.
- Comes with nickel plated wire.
- Available in standard and premium paint selections. See Textiles and Finishes (page 240) for a complete list of offerings and conditions.

DESCRIPTION	PRODUCT CODE	LIST PRICE	DIMENSIONS/INCHES		
			H	W	D
Flip Sorter	EVAFS01	39	9.25	2.75	9.25

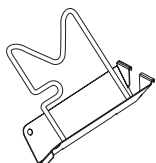

**EVAPP01 - MAIL BOX**

- Must be ordered in conjunction with a load bar option.
- Can be used with slat wall module.
- Available in standard and premium paint selections. See Textiles and Finishes (page 240) for a complete list of offerings and conditions.

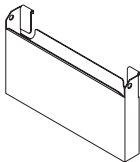
	DESCRIPTION	PRODUCT CODE	LIST PRICE	DIMENSIONS/INCHES		
				H	W	D
	Mail Box	EVAPP01	68	9	12	2.75

**EVATH01 - TELEPHONE HOLDER**

- Must be ordered in conjunction with a load bar option.
- Can be used with slat wall module.
- Available in standard and premium paint selections. See Textiles and Finishes (page 240) for a complete list of offerings and conditions.

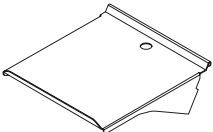
	DESCRIPTION	PRODUCT CODE	LIST PRICE	DIMENSIONS/INCHES		
				H	W	D
	Telephone Holder	EVATH01	65	2	9	10

**EVANP02 - NAME PLATE**

- Name Plate attached to 1" increment slots.
- Available in single sided (parallel to panel) or double sided (perpendicular to panel) for isle application displaying name on both sides.
- Injection molded frame and die cast base with black rubberized finish.
- Includes two slide-in name cards, steel brackets and fasteners.
- Available in black only.
- Free template for additional slide-in name cards are available at [http://www.evolvefurnituregroup.com/Product\\_Sheets.html](http://www.evolvefurnituregroup.com/Product_Sheets.html)

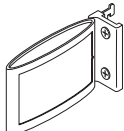
	DESCRIPTION	PRODUCT CODE	LIST PRICE	DIMENSIONS/INCHES		
				H	W	D
	Name Plate	EVANP02	99	3.30	5.3	1.25

**EVACH01 - COAT HOOK**

- Panel mounted coat hook.
- Available in standard and premium paint selections. See Textiles and Finishes (page 240) for a complete list of offerings and conditions.

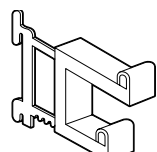
	DESCRIPTION	PRODUCT CODE	LIST PRICE	DIMENSIONS/INCHES		
				H	W	D
	Coat Hook	EVACH01	42		3	.75



**EVWAKM01 - SOFT TOUCH KEYBOARD SUPPORT MECHANISM**

- Height range 6" (+1.0"/-5.0").
- Soft touch knob tilt adjustable range +15°/-15°.
- 360° base swivel.
- Soft touch knob for simultaneous height and tilt adjustment.
- Spring-assisted mechanism helps counter balance weight of keyboard and tray.
- Low profile design for maximum leg room.
- Includes 21.75" under worksurface glide track as standard. Optional 12" and 18" glide tracks are available at no upcharge. Contact Evolve Customer Support for details.
- Keyboard support mechanisms and trays available in Black only.

	DESCRIPTION	PRODUCT CODE	LIST PRICE	DIMENSIONS/INCHES		
				H	W	D

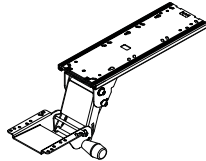

Soft Touch Keyboard Support Mechanism	EVWAKM01	213			
---------------------------------------	----------	-----	--	--	--

**EVWAKM02 - LIFT-N-LOCK KEYBOARD SUPPORT MECHANISM**

- Height range 8.38" (+2.25"/-6.13").
- Dial-tilt gauge shows precise tilt angle from +10°/-15° positions.
- 360° base swivel.
- Patent pending height indicator gauge allows for precise height setting when used by multiple users, or for returning to optimal height setting after storage.
- Patented Lift-N-Lock height adjustment without knobs or levelers automatically locks into position with release of tray for greater ADA/Barrier Free compliance.
- Exceeds BIFMA performance standards.
- Includes 21.75" under worksurface glide track as standard. Optional 12" and 18" glide tracks are available at no upcharge. Contact Evolve Customer Support for details.
- Keyboard support mechanisms and trays available in Black only.
- Positive Tilt Lockout available. Contact Evolve Customer Support for details.

	DESCRIPTION	PRODUCT CODE	LIST PRICE	DIMENSIONS/INCHES		
				H	W	D

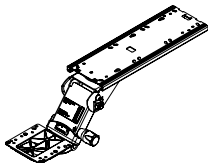

Lift-N-Lock Keyboard Support Mechanism	EVWAKM02	280			
--	----------	-----	--	--	--

**EVWAKM03 - LIFT-N-LOCK SIT-STAND KEYBOARD SUPPORT MECHANISM**

- Height range 14.13" (+8.25"/-5.88")
- Dial-tilt gauge shows precise tilt angle from +10°/-15°.
- 360° base swivel.
- Patent pending height indicator gauge allows for precise height setting when used by multiple users, or for returning to optimal height setting after storage.
- Curved neck allows user to be closer to the desk when in standing position.
- Exceeds BIFMA performance standards.
- Includes 21.75" under worksurface glide track as standard. Optional 12" and 18" glide tracks are available at no upcharge. Contact Evolve Customer Support for details.
- Keyboard support mechanisms and trays available in Black only.
- Positive tilt lockout available. Contact Evolve Customer Service for details.
- Maximizes ergonomic support for both seated and standing positions.
- Patented Lift-N-Lock height adjustment without knobs or levelers automatically locks into position with release of tray for greater ADA/Barrier Free compliance.

	DESCRIPTION	PRODUCT CODE	LIST PRICE	DIMENSIONS/INCHES		
				H	W	D

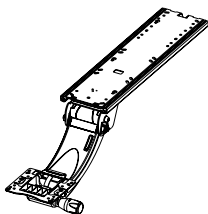

Lift-N-Lock Sit-Stand Keyboard Support Mechanism	EVWAKM03	451			
--	----------	-----	--	--	--

**EVWAKT01 - MDF TRAY WITH SLIDING MOUSE SUPPORT**

- Formed MDF tray with textured finish and a foam anti-skid mat.
- Sliding retractable mouse support slides below tray for left or right mouse positioning.
- Extends 9.91" beyond the end of the keyboard tray.
- Keyboard support mechanisms and trays available in Black only.

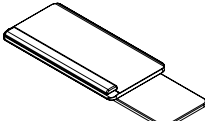
	DESCRIPTION	PRODUCT CODE	LIST PRICE	DIMENSIONS/INCHES		
				H	W	D
	MDF Tray with Sliding Mouse Support	EVWAKT01	215	21.3	10.5	

**EVWAKT02 - 27" HDPE TRAY WITH TWO MOUSING SURFACES**

- HDPE tray is 1/2" thick high density polyethylene with textured finish.
- Includes removable plug-in, gel free foam palm rest and anti-skid straps.
- Keyboard and mouse can be placed left or right.
- Includes mouse fence with cable manager.
- Keyboard support mechanisms and trays available in Black only.

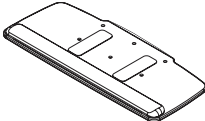
	DESCRIPTION	PRODUCT CODE	LIST PRICE	DIMENSIONS/INCHES		
				H	W	D
	27" HDPE Tray with Two	EVWAKT02	277	27.5	11.5	

**EVWAKT03 - PHENOLIC TRAY WITH HEIGHT ADJUSTABLE MOUSE SUPPORT**

- Solid low profile keyboard tray with graphite finish to help hide fingerprints and smudges.
- Includes removable plug-in, gel free foam palm rest and anti-skid straps.
- Height adjustable mouse support provides ergonomic adjustment of tilt, swivel and height adjustments.
- Keyboard and mouse can mount left or right.
- Mousing surface includes mouse fence with cable manager.
- Keyboard support mechanisms and trays available in Black only.

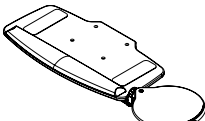
	DESCRIPTION	PRODUCT CODE	LIST PRICE	DIMENSIONS/INCHES		
				H	W	D
	Phenolic Tray with Height Adjustable Mouse Support	EVWAKT03	299	23	11.5	

**EVWAKT04 - 1/2" HDPE TRAY WITH HEIGHT ADJUSTABLE MOUSE SUPPORT**

- 1/2" thick high density polyethylene with textured finish.
- HDPE includes removable plug-in, gel free foam palm rest and anti-skid straps.
- Height adjustable mouse support with ergonomic adjustment of tilt, swivel and height adjustment.
- Can mount left or right and includes mouse fence and cable manager.
- Keyboard support mechanisms and trays available in Black only.

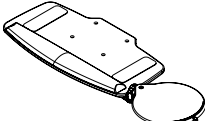
	DESCRIPTION	PRODUCT CODE	LIST PRICE	DIMENSIONS/INCHES		
				H	W	D
	1/2" HDPE Tray with Height Adjustable Mouse Support	EVWAKT04	334	23	11.5	



KEYBOARD COMBINATION CHART - PACKAGED CODES

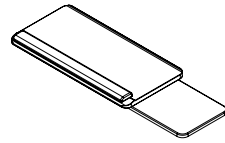

**EVWAKT01**

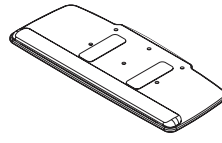

**EVWAKT02**

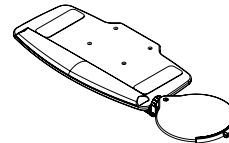

**EVWAKT03**

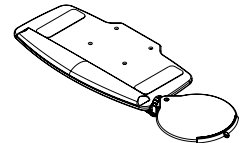

**EVWAKT04**

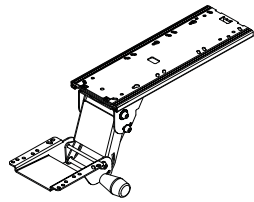

**EVWAKM01**

**EVWAKK101**  
\$428

**EVWAKK102**  
\$490

**EVWAKK103**  
\$512

**EVWAKK104**  
\$547

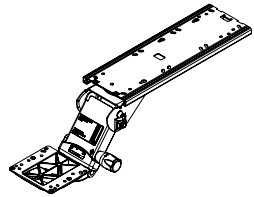

**EVWAKM02**

**EVWAKK201**  
\$494

**EVWAKK202**  
\$556

**EVWAKK203**  
\$580

**EVWAKK204**  
\$614

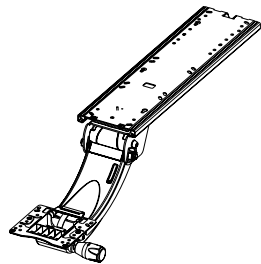

**EVWAKM03**

**EVWAKK301**  
\$666

**EVWAKK302**  
\$726

**EVWAKK303**  
\$750

**EVWAKK304**  
\$785



**MONITOR ARM SPECIFICATIONS (APPLIES TO ALL EVOLVE MONITOR ARMS LISTED BELOW):**

- VESA mounting plate contains 75mm & 100mm mounting configuration.
- VESA plate head is fully adjustable with 180° of tilt, 180° of swivel and 360° of rotation for portrait to landscape viewing.
- Keyhole slots in VESA plate for quick mounting of display screen.
- Counterbalance spring mechanism does not contain gas cylinders (that are prone to leakage).
- Cable management provided on arm swivel joints.
- Arm components manufactured from 100% recyclable aluminum dye cast material, providing stability and durability.
- 13" arm height adjustment on 11" stainless steel pole.
- Pole support ring doubles as cable manager.
- 360° of arm swivel around pole.
- Desk clamp and grommet mounting options standard on pole applications.

**EVLCD01 - HEIGHT ADJUSTABLE FLAT SCREEN MONITOR ARM**

- Mounting brackets secures the arm mechanism to Evolve ganging load bar to slat wall.
- Smooth horizontal adjustment.
- Smooth vertical adjustment.
- Additional stepped vertical adjustment by alteration of the supporting rails height.
- Sliding brackets with set screws prevents dislodgement from supporting rails.
- Includes adjustable slat wall package, single height adjustable arm package, monitor mount package and allen key.
- Available in Black (BLK), Silver (SIL) and White (WHT).

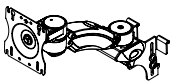
	DESCRIPTION	PRODUCT CODE	LIST PRICE	DIMENSIONS/INCHES		
				H	W	D
	Height adjustable flat screen monitor arm	EVLCD01	473	9	5	15

**EVLCD02 - NON-HEIGHT ADJUSTABLE FLAT SCREEN MONITOR ARM**

- Mounting brackets secures the arm mechanism to Evolve ganging load bar to slat wall.
- Smooth horizontal adjustment.
- Stepped vertical adjustment by alteration of the supporting rails height.
- Sliding brackets with set screws prevents dislodgement from supporting rails.
- Includes adjustable slat wall package, single height adjustable arm package, monitor mount package and allen key.
- Available in Black (BLK), Silver (SIL) and White (WHT).

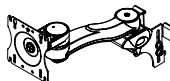
	DESCRIPTION	PRODUCT CODE	LIST PRICE	DIMENSIONS/INCHES		
				H	W	D
	Non-Height adjustable flat screen monitor arm	EVLCD02	362	9	5	15

**EVLCD03 - MONITOR ARM - SINGLE SCREEN/SINGLE EXTENSION**

- Display viewing - 180° of tilt, 180° of swivel and 360° of rotation.
- Quick-release VESA plate included.
- 9" pole adjustment.
- Available in White (WHT), Black (BLK) and Silver (SIL). Post is chromed.

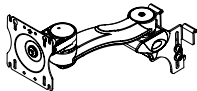
	DESCRIPTION	PRODUCT CODE	LIST PRICE	DIMENSIONS/INCHES		
				H	D	W
	Monitor Arm - Single Screen Single Extension	EVLCD03	362			



**EVLCD04 - MONITOR ARM - SINGLE SCREEN/DUAL EXTENSION/HEIGHT ADJUSTABLE**

- Frees up valuable worksurface space and supports a sit/stand working posture.
- Attaches to any standard worksurface with a flush edge, or through a grommet.
- Monitor arm adjusts from 3" to 12" above worksurface.
- Counterbalanced arm provides an additional 13" of height adjustment.
- Monitor connecting bracket swivels 360° and tilts +/- 90° (180°).
- Double extension has 19" of back and forth movement to allow for different vocal depths of viewing comfort.
- Built-in cable clips on underside of extension arms and pole base allows organized cable management.
- Quick-release VESA plate included.
- Available in White (WHT), Black (BLK) and Silver (SIL). Post is chromed.

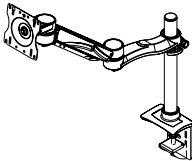
	DESCRIPTION	PRODUCT CODE	LIST PRICE	DIMENSIONS/INCHES		
				H	W	D
	Monitor Arm - Single Screen Dual Extension/Height Adjustable	EVLCD04	518			

**EVLCD05 - MONITOR ARM - DUAL SCREEN/DUAL EXTENSION**

- Frees up valuable worksurface space.
- Used for side-by-side or back-to-back applications.
- Attaches to any standard worksurface with flush edge or through a grommet.
- Monitor arm adjusts from 3" to 12" above worksurface.
- Monitor connecting extension has 19" of back and forth movement to allow for different vocal depths of viewing comfort.
- Built-in cable clips on underside of extension arms and pole base allows organized cable management.
- Quick-release VESA plate included.
- Available in White (WHT), Black (BLK) and Silver (SIL). Post is chromed.

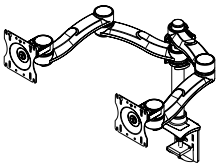
	DESCRIPTION	PRODUCT CODE	LIST PRICE	DIMENSIONS/INCHES		
				H	W	D
	Monitor Arm - Dual Screen	EVLCD05	762			

**EVLCD06 - MONITOR ARM - DUAL SCREEN/DUAL EXTENSION/HEIGHT ADJUSTABLE**

- Frees up valuable worksurface space and supports a sit/stand working posture.
- Used for side-by-side or back-to-back applications.
- Attaches to any standard worksurface with flush edge or through a grommet.
- Monitor arm adjusts from 3" to 12" above worksurface.
- Counterbalanced arm provides an additional 13" of height adjustment.
- Monitor connecting bracket swivels 360° and tilts +/- 90° (180°).
- Double extension has 19" of back and forth movement to allow for different vocal depths of viewing comfort.
- Built in cable clips on underside of extension arms and pole base allows organized cable management.
- Quick-release VESA plate included.
- Available in White (WHT), Black (BLK) and Silver (SIL).

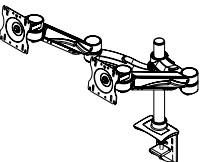
	DESCRIPTION	PRODUCT CODE	LIST PRICE	DIMENSIONS/INCHES		
				H	W	D
	Monitor Arm - Dual Screen Dual Extension/Height Adjustable	EVLCD06	945			

**EVLCD07 - SLAT WALL MONITOR ARM - DUAL EXTENSION/HEIGHT ADJUSTABLE**

- Spring counterbalanced height adjustable arm extension provides free floating vertical range of movement through 13" of travel.
- VESA mounting plates contain 75mm and 100mm mounting configuration.
- 180-degree of arm swivel around slat wall mounting bracket pivot point.
- VESA plate head is fully adjustable with 180-degree of tilt, 180-degree of swivel and 360-degree of rotation for portrait to landscape viewing.
- Keyhole slots in VESA plate for quick mounting of display screen.
- Slat wall bracket clamps to Slat Wall via adjustable brackets allowing for easy installation and removal (installation tools provided).
- Cable management provided on arm swivel points.
- Arm components manufactured from 100% recyclable aluminum dye cast material, providing stability and durability.
- Friction screw adjustment on arm segments for touch screen applications.
- Available in White (WHT), Black (BLK) and Silver (SIL). Post is chromed.

DESCRIPTION	PRODUCT CODE	LIST PRICE	DIMENSIONS/INCHES		
			H	W	D

Slat Wall Monitor Arm Dual Extension/Height Adjustable	EVLCD07	540			
---	---------	-----	--	--	--

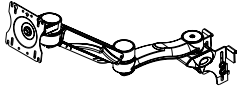

**EVLCD08 - MONITOR ARM - SINGLE SCREEN/DUAL EXTENSION**

- 9 1/2" reach from center of pole to front of VESA plate.
- Display viewing - 180° of tilt, 180° of swivel and 360° of rotation.
- Quick-release VESA plate included.
- 9" pole adjustment.
- Available in White (WHT), Black (BLK) and Silver (SIL). Post is chromed.

DESCRIPTION	PRODUCT CODE	LIST PRICE	DIMENSIONS/INCHES		
			H	W	D

Monitor Arm - Single Screen Dual Extension	EVLCD08	431			
---	---------	-----	--	--	--

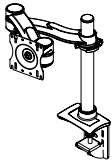

**EVLCD09 - SINGLE SCREEN MONITOR ARM - FOR 5 TO 20LBS**

- Adjustable counterbalance cylinder provides smooth 14 1/2" of height adjustment with fingertip control - counterbalances monitors from 5 lbs. to 20 lbs.
- Double extension arms provide a maximum of 26 3/4" extension from the rear edge of the mounting surface to the VESA Plate for greater monitor adjustment on deep or corner workstations.
- Arms fold back to a minimum dimension of 4 1/2" to provide maximum desk utilization.
- Weight gauge provided to allow for quick and easy counterbalance adjustment of the arm prior to installing the screen.
- Saves time and guesswork especially for multiple arm installations.
- Die cast aluminum construction provides greater stability and contains high recycled material content with full recyclability.
- Adjustable rotation limiter to restrict arm rotation to 180°, preventing arms from hitting walls.
- Comes with all tools and mounting hardware for quick and easy installation (Tool-free).
- Available in White (WHT), Black (BLK) and Silver Metallic (SIL). Post is chromed.

DESCRIPTION	PRODUCT CODE	LIST PRICE	DIMENSIONS/INCHES		
			H	W	D

Single Screen Monitor Arm - For 5 to 20 lbs.	EVLCD09	483	38	6	8.5
--	---------	-----	----	---	-----

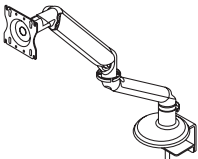

# ACCESSORIES

## EVLCD12 - MONITOR ARM - PARABOLIC QUAD SCREEN, BEAM MOUNT

- Available in White (WHT), Black (BLK) and Silver Metallic (SIL). Post is chromed.
- Frees up valuable worksurface space.
- Double extension has 19" of back and forth movement to allow for different vocal depths of viewing comfort.
- Adjust from 3" to 12" above worksurface.
- Counter-balance arm provides an additional 6" of height adjustment.
- Quick-release VESA plate included.

DESCRIPTION	PRODUCT CODE	LIST PRICE	DIMENSIONS/INCHES		
			H	W	D
Monitor Arm - Parabolic Quad Screen	EVLCD12	1236			

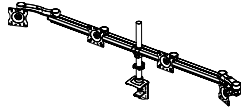

## EVCPU - CPU HOLDER

- CPU holder with soft touch knob.
- Vertical underside storage space.
- Maintains CPU at set height.
- Inside width adjustment 3.5" — 9.25"
- Inside vertical adjustment 12.25" — 22.25"
- Load rating: 85lbs.
- Available in black only.

DESCRIPTION	PRODUCT CODE	LIST PRICE	DIMENSIONS/INCHES		
			H	W	D
CPU Holder	EVCPU01	231	14	8.25	7.75

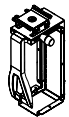

## EVCPU02 - CPU HOLDER ON GLIDE TRACK

- Accepts tower CPUs with a width range of 3.5" to 9.3" and a height range of 12.5" to 22.5".
- Soft touch knob for side clamp adjustment and bayonet lance for vertical height adjustment.
- 12" glide track mounted and 360-degree swivel for easy access to rear of CPU.
- Manufactured from steel and engineered resin, providing rugged durability and support.
- Available in Black only.

DESCRIPTION	PRODUCT CODE	LIST PRICE	DIMENSIONS/INCHES		
			H	W	D
CPU Holder on Glide Track	EVCPU02	253			

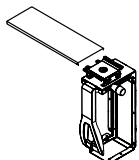

## EVWALS01 - LAPTOP SUPPORT WITH INTEGRATED 4 PORT USB HUB

- 5 adjustment angles for ergonomic viewing.
- Adjustment arm allows for unrestricted air flow.
- 4 port USB hub powered by a computer, no external power required.
- Fully compliant with universal serial bus specifications 2.0.
- Over current protection for downstream port.
- Compatible with Windows 7, XP, 98, ME, 2000 and Vista. Also compatible with MAC OS 8x, 9x, and 10.
- CE/UL/FCC approved and RoHS compliant. Available in Black and Grey.

DESCRIPTION	PRODUCT CODE	LIST PRICE	DIMENSIONS/INCHES		
			H	W	D
Laptop Support with Integrated 4 Port USB Hub	EVWALS01	132			



# ACCESSORIES

## EVWADH01 - DESKTOP DOCUMENT HOLDER

- Dimensions of 16 1/2" wide x 10" high x 8" deep.
- Heavy duty steel easel support.
- Magnetic line glide.
- Available in Black only.

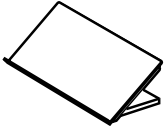
	DESCRIPTION	PRODUCT CODE	LIST PRICE	DIMENSIONS/INCHES		
				H	W	D
	Desktop Document Holder	EVWADH01	132			

## EVWAFR01 - ADJUSTABLE FOOT REST

- Provides support for the 5th percentile female when chair adjustment is not adequate.
- Easily adjustable to angles of 6°, 12°, 16° and 25°.
- Footrest surface covered with anti-fatigue rubber mat.
- Available in Black/Grey combination only.

	DESCRIPTION	PRODUCT CODE	LIST PRICE	DIMENSIONS/INCHES		
				H	W	D
	Adjustable Foot Rest	EVWAFR01	132			

## EVWACP - CRT CORNER PLATE

- Converts two abutting worksurfaces in a 90° corner into a 45° angle keyboard worksurface.
- Keyboard mechanism not included.
- Must specify paint color.
- Made of metal.

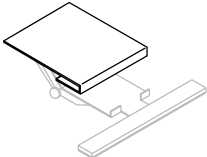
	DESCRIPTION	PRODUCT CODE	LIST PRICE	DIMENSIONS/INCHES		
				H	W	D
	CRT Corner Plate	EVWACP1818	71	1.125	18	18

## EVATP - TOUCH-UP PAINT KIT

- Available in standard Evolve paint colors to facilitate easy touch-ups.
- 1/2 fl. ounce bottle (spray not available).
- Specify color.

	DESCRIPTION	PRODUCT CODE	LIST PRICE	DIMENSIONS/INCHES		
				H	W	D
	Touch-Up Paint Kit	EVATP01	32			



# textiles and finishes

## Care and Cleaning

The following guide encompasses the Evolve System line.

The guide was compiled using information from our "raw" material suppliers and is relevant only to our standard offering finishes and textiles.

---

### FABRICS

To extend the life of your upholstered panels, regularly dust the panel to prevent airborne particles from penetrating the fabric surface.

For light soiling, use a damp cloth and blot the spot with very slight pressure, taking care never to soak the fabric. Dry with a clean cloth by blotting - never rub fabric. More intense stains can be treated the same way, but with a mild detergent. Always test fabric first in an unseen area before using any cleaning method.

### PANEL FRAMES

The panel frames are manufactured out of sturdy aluminum with a powder coated enamel paint finish. To clean the frames of the panels, and all hardware associated with the Evolve line, simply utilize a clean, damp cloth. For stubborn stains on the panel frames, you may consider adding a mild detergent.

### GLAZED PANELS

Cleaning of the glazing in panels should only be done with a damp lint-free cloth. A mild detergent can be used if necessary. Do not use paper towels in combination with a window cleaner-this may cause scratches to the glazing.

### WORKSURFACES

The worksurfaces are manufactured using primarily Nevamar Brand laminates as the exposed surface. To properly clean these areas, it is best to use a clean, damp cloth and circular motion to prevent streaks. For stubborn stains, you are able to add a mild detergent to the water. Be certain not to use an ammonia-based solution. It will react with the PVC, or wood edge trim, causing permanent damage to the contacted areas.

### ACCESSORIES

The accessories sold with the Evolve product line can be simply cleaned with a clean, damp cloth. If they are really dirty, a mild, non-abrasive solution may be added. Wipe with a damp cloth after the solution, and finally, a dry cloth.

**LAMINATES – THERMALLY FUSED**

Absolute Acajou*	<b>W150LP</b>
Asian Night*	<b>794938LP</b>
Avant Cherry*	<b>W357LP</b>
Avant Honey*	<b>W356LP</b>
Black*	<b>1595-60LP</b>
Blizzard	<b>BZDLP</b>
Brushed Cobalt	<b>BRCLP</b>
Clear Maple*	<b>WM8340TLP</b>
Constellation Java*	<b>T823</b>
Custom Grey	<b>S548LP</b>
Dark Espresso*	<b>W142LP</b>
Desert Zephyr	<b>4841-60LP</b>
Empire Mahogany+	<b>7122K-07LP</b>
Grey	<b>T551</b>
Grey Matrix	<b>MR61TLP</b>
Hayden Grey (Taupe)*	<b>S427LP</b>
Loden Zephyr	<b>4844-60LP</b>
Manitoba Maple	<b>7911-60LP</b>
Misted Zephyr	<b>4843-60LP</b>
Pearl Bisque	<b>D485-07LP</b>
Pearl Dust*	<b>D488-07LP</b>
Shaker Cherry*	<b>7935K-07LP</b>
Stone Dust	<b>SDTLP</b>
Storm Grey	<b>T565</b>
Studio White Matrix	<b>MR71TLP</b>
String	<b>S477</b>
Tiger Fruitwood*	<b>T821</b>
Tiger Mahogany*	<b>T822</b>
Tiger Maple*	<b>T820</b>
Tiger Walnut*	<b>T819</b>
Titanium	<b>4810-60LP</b>
True White	<b>S645LP</b>
Willow Grey	<b>T431</b>
Winter Cherry	<b>WCR1P</b>
White Chocolate*	<b>T492LP</b>

Additional paint and laminates may be available. Contact Evolve Customer Support for details.

\* Matching Wood Grain PVC edge available.

+ For matching purposes Empire Mahogany laminate can be coordinated with Global's Quartered Mahogany laminate and PVC trim.

\* PVC panel and connector trims are discontinued. Effective 12/2014

\* 1 1/8" Worksurfaces are discontinued. Effective December 2014

**LAMINATES – HIGH PRESSURE**

Absolute Acajou*	<b>W150HP</b>
Asian Night*	<b>794938HP</b>
Avant Cherry*	<b>W357HP</b>
Avant Honey*	<b>W356HP</b>
Black*	<b>1595-60HP</b>
Blizzard	<b>BZDHP</b>
Brushed Cobalt	<b>BRCHP</b>
Clear Maple*	<b>WM8340THP</b>
Constellation Java*	<b>H823</b>
Custom Grey	<b>S548HP</b>
Dark Espresso*	<b>W142HP</b>
Desert Zephyr	<b>4841-60HP</b>
Designer White*	<b>D354-60HP</b>
Empire Mahogany+	<b>7122K-07HP</b>
Grey	<b>H551</b>
Grey Matrix	<b>MR61T</b>
Hayden Grey (Taupe)*	<b>HP427</b>
Loden Zephyr	<b>4844-60HP</b>
Manitoba Maple	<b>7911-60HP</b>
Misted Zephyr	<b>4843-60HP</b>
Pearl Bisque	<b>D485-07HP</b>
Pearl Dust*	<b>D488-07HP</b>
Shaker Cherry*	<b>7935K-07HP</b>
Stone Dust	<b>SDTHP</b>
Storm Grey	<b>H565</b>
Studio White Matrix	<b>MR71THP</b>
String	<b>S652T</b>
Tiger Fruitwood*	<b>H821</b>
Tiger Mahogany*	<b>H822</b>
Tiger Maple*	<b>H820</b>
Tiger Walnut*	<b>H819</b>
Titanium	<b>4810-60HP</b>
Willow Grey	<b>H431</b>
Winter Cherry	<b>WCRHP</b>
White Chocolate*	<b>T492HP</b>

Additional paint and laminates may be available. Contact Evolve Customer Support for details.

\*Matching Wood Grain PVC edge available.

**PVC EDGE TRIM**

Absolute Acajou	<b>AAE</b>
Asian Night	<b>ASE</b>
Avant Cherry	<b>ACE</b>
Avant Honey	<b>AHE</b>
Avant Maple	<b>AME</b>
Black	<b>BLK</b>
Brushed Cobalt	<b>BRC</b>
Charcoal	<b>CHR</b>
Clear Maple	<b>CME</b>
Constellation Java	<b>CSJ</b>
Dark Espresso*	<b>DES</b>
Designer White	<b>DWE</b>
Nevada	<b>NEV</b>
Pearl Dust	<b>PDE</b>
Quartered Mahogany	<b>QTM</b>
Shaker Cherry	<b>SKE</b>
Silver	<b>SIL</b>
Taupe	<b>TPE</b>
Tiger Fruitwood*	<b>TFW</b>

Tiger Mahogany	<b>TMA</b>
Tiger Maple*	<b>TMP</b>
Tiger Walnut*	<b>TWL</b>
Tungsten	<b>TUN</b>
White Chocolate*	<b>CBE</b>

\* 1 7/16" HPW PVC Trim for Worksu faces is not available in Dark Espresso (DES), Tiger Fruitwood (TFW), Tiger Maple (TMP) and Tiger Walnut (TWL).

**WOOD VENEER WORKSURFACES\***

Biscotti	<b>VBO</b>
Caramel Bamboo	<b>VBM</b>
Cocoa Walnut	<b>VCW</b>
Dark Cherry	<b>VDC</b>
Espresso Walnut	<b>VEW</b>
Hazelnut	<b>VHM</b>
Honey Maple	<b>VMS</b>
Java	<b>VJO</b>
Latte Walnut	<b>VLW</b>
Natural Cherry	<b>VNC</b>
Natural Maple	<b>VMP</b>
Red Cherry	<b>VRC</b>
Tuscan Walnut	<b>VTW</b>
Walnut	<b>VWL</b>
Warm Cherry	<b>VWC</b>

All wood veneer worksurfaces are 1.38" thick.

\*Note: Wood veneer options for worksurfaces are available at an up charge and with an extended lead time. Contact Evolve Customer Support for details.

**ACCENT PAINTED FINISHES**

Crystal Blue	<b>CYB</b>
Lime Green	<b>LMG</b>
Orange Flame	<b>ORF</b>
Steel Blue	<b>STB</b>
Vermilion Red	<b>VLR</b>

Accessory painted finishes are subject to 10% upcharge and minimum order of 50 pieces, orders under 50 pieces subject to \$500 net fee

**STANDARD PAINT & FRAME COLORS**

(for application to trim, steel components, PVC, vertical and horizontal members)

Black	<b>BLK</b>
Blizzard (Textured)	<b>BZD</b>
Charcoal	<b>CHR</b>
Designer White	<b>DWT</b>
Nevada	<b>NEV</b>
Silver	<b>SIL</b>
Steel	<b>STL</b>
Stone Dust (Textured)	<b>SDT</b>
Taupe	<b>TPE</b>
Tungsten <sup>o</sup>	<b>TUN</b>

Additional paint and laminates may be available. Contact Evolve Customer Support for details.

<sup>o</sup>Tungsten paint is subject to 10% upcharge EXCEPT on Worksurfaces, PVC items, or when PVC trim components are ordered separately.

**PREMIUM PAINT & FRAME COLORS**

Black Coffee*	<b>U04</b>
Bone*	<b>F29</b>
Business Gray*	<b>BGR</b>
Cappuccino*	<b>T20</b>
Claret*	<b>F09</b>
Cloud*	<b>F23</b>
Dark Chocolate*	<b>T19</b>
Desert Putty*	<b>DPT</b>
Gray*	<b>GRY</b>
Ice*	<b>F33</b>
Ivory*	<b>F30</b>
Light Gray*	<b>LGR</b>
Metro*	<b>F07</b>
Mocha*	<b>J52</b>
Moss*	<b>F05</b>
Navy*	<b>F19</b>
Oyster*	<b>F35</b>
Stone*	<b>F32</b>
Storm Grey*	<b>SGR</b>
Tahiti Sand*	<b>TSA</b>
Vanilla*	<b>J23</b>
Willow*	<b>F28</b>

\*Premium paint selections are available on the following components: Panels (top trim and frame), Hardware, End-of run/Post Kits, and Accessories at a 22% upcharge. Storage with no upcharge.

\*Please note all Double Wall Storage units must be ordered in a minimum quantity of 50 when ordering in a premium paint finish. Different model types can be combined to achieve the minimum quantity required. See pages 192-193 for affected models.

All special and premium paint match orders of 50 panels or less will incur a \$500 net setup fee. Panels, hardware, accessories and storage may be combined on orders to achieve minimum of 50 pieces or more and will not be subject to \$500 net set up fee. Add on orders will not have that charge for 90 days after the original order has shipped and must have the original PO# quoted otherwise they will not qualify for the program.

Global matte paint finishes are available on most Evolve Storage pieces without an up charge regardless of quantities.

All Mica and Metallic paint finishes will incur a minimum up charge of 10%.

All non-standard paint finishes must be approved by Evolve prior to placing an order.

ADA Overheads are not available in Evolve premium color paints. ADA Overheads are available in Evolve standard paint colors only.

Frames for all Open Panel models, all panel retainers, PVC components for panels and connectors are unavailable in premium or special/custom paint colors. They are available in standard Evolve paint colors only.



**PANEL FABRICS – GRADE 1**

**Anchorage** - 35% Post - consumer Recycled Polyester and 65% Pre -consumer Recycled Polyester

Birch .....	<b>AN40</b>
Green Apple .....	<b>AN41</b>
Lapis .....	<b>AN42</b>
Straw .....	<b>AN43</b>
Wolf .....	<b>AN44</b>
Goose .....	<b>AN45</b>
Angora .....	<b>AN46</b>
Cumin .....	<b>AN47</b>
Asteriod .....	<b>AN48</b>
Geranium .....	<b>AN49</b>
Thistle .....	<b>AN50</b>
Graphite .....	<b>AN51</b>
Slate .....	<b>AN52</b>
Quarry Blue .....	<b>AN53</b>
Onyx .....	<b>AN54</b>
Pumpkin .....	<b>AN55</b>
Red Delicious .....	<b>AN56</b>
Sunshine .....	<b>AN57</b>
Magenta .....	<b>AN58</b>
Waterfall .....	<b>AN59</b>
Green Olive .....	<b>AN60</b>
Vanilla .....	<b>AN61</b>
Cobalt .....	<b>AN62</b>

**Birdseye** - 100% Recycled Polyester

Outlook .....	<b>BE21</b>
Rock .....	<b>BE22</b>
Vista .....	<b>BE23</b>
Soar .....	<b>BE24</b>
Impression .....	<b>BE25</b>
Glide .....	<b>BE26</b>
Panorama .....	<b>BE27</b>
Storm .....	<b>BE28</b>
Flight .....	<b>BE29</b>
Altitude .....	<b>BE30</b>

**Loopy** - 100% Recycled Polyester

Oyster .....	<b>LP60</b>
Putty .....	<b>LP61</b>
Marble .....	<b>LP62</b>
Hazelnut .....	<b>LP63</b>
Latte .....	<b>LP64</b>
Bay .....	<b>LP65</b>
Wild Rice .....	<b>LP66</b>
Harbor .....	<b>LP67</b>

**Melody** - 100% Recycled Polyester

Spray .....	<b>ME40</b>
Pond .....	<b>ME41</b>
Sand Bar .....	<b>ME42</b>
Silt .....	<b>ME43</b>
Pebble .....	<b>ME44</b>
Lake .....	<b>ME45</b>
Gravel .....	<b>ME46</b>
Boulder .....	<b>ME47</b>

**Meander** - 100% Polyester

Sandshell .....	<b>MN71</b>
Overcast .....	<b>MN72</b>
Agate Taupe .....	<b>MN73</b>

**Streak** - 100% Recycled Polyester

Camp .....	<b>SR80</b>
Beach .....	<b>SR81</b>
Stream .....	<b>SR82</b>
Stripe .....	<b>SR83</b>
Ridge .....	<b>SR84</b>
Beam .....	<b>SR85</b>
Shade .....	<b>SR86</b>
Ray .....	<b>SR87</b>

**Tek** - 100% Recycled Polyester

Finesse .....	<b>TX60</b>
Grain .....	<b>TX61</b>
Essence .....	<b>TX62</b>
Web .....	<b>TX63</b>
Warp .....	<b>TX64</b>
Nature .....	<b>TX65</b>
Wind .....	<b>TX66</b>
Mesh .....	<b>TX67</b>
Weave .....	<b>TX68</b>
Form .....	<b>TX69</b>

**Universe** - 100% Polyester

Milkyway .....	<b>UV01</b>
Crepe Brulee .....	<b>UV02</b>
Whitecap .....	<b>UV03</b>
Wheat .....	<b>UV04</b>
Seneca .....	<b>UV05</b>
Mica .....	<b>UV06</b>
Cosmic .....	<b>UV07</b>
Depth .....	<b>UV08</b>

**PANEL FABRICS – GRADE 2**

**Cyclone** - 56% post-consumer recycled polyester and 44% polyester.

Wrought Iron .....	<b>IM36</b>
Stove Pipe .....	<b>IM37</b>
Stainless .....	<b>IM40</b>
Polished Pewter .....	<b>IM41</b>
Welded Steel .....	<b>IM43</b>
Etched Bronze .....	<b>IM44</b>
Fired Titanium .....	<b>IM46</b>
Chrome .....	<b>IM49</b>
Dark Annealed .....	<b>IM50</b>
Karat .....	<b>IM54</b>
Red Metal .....	<b>IM55</b>
Oxidized Bronze .....	<b>IM56</b>
Bright Ray .....	<b>IM57</b>
Bismuth Crystal .....	<b>IM58</b>
Gallium Blue .....	<b>IM59</b>

**Frost** - 100% EcoPolyester

Dew .....	<b>FR30</b>
Earth .....	<b>FR31</b>
Blight .....	<b>FR32</b>
Chill .....	<b>FR34</b>

**Mesh** - 100% Recycled Polyester

Canyon .....	<b>B33A</b>
Napa Valley .....	<b>B34A</b>
Huntington .....	<b>B36A</b>
Huron .....	<b>B37A</b>
Heartland .....	<b>B39A</b>
Oat .....	<b>B81A</b>
Pepper .....	<b>B82A</b>
Limestone .....	<b>B84A</b>
Zinc .....	<b>B86A</b>

**Peripheral** - 100% Eco Polyester

Smut .....	<b>PE82</b>
Smudge .....	<b>PE83</b>
Coal .....	<b>PE84</b>
Ash .....	<b>PE85</b>
Cream .....	<b>PE86</b>
Powder .....	<b>PE87</b>



**GRADE 1 (VINYL)**

*For availability of chair series in Vinyl, please contact a Global Sales Representative.*

**Leatherite - 100% Polyvinyl Chloride / 100% Polyester Backing**

Light Grey .....	<b>66</b>
Charcoal .....	<b>67</b>
Dark Orange .....	<b>68</b>
Black .....	<b>70</b>
Chocolate .....	<b>79</b>
Soft Yellow .....	<b>80</b>
Bright Red .....	<b>81</b>
Pure White .....	<b>82</b>
Off White .....	<b>83</b>
Beige .....	<b>84</b>
Wheat .....	<b>85</b>
Golden Tan .....	<b>86</b>
Sage .....	<b>87</b>
Dark Green .....	<b>88</b>
Hunter .....	<b>89</b>
Purple .....	<b>90</b>
Purple Gray .....	<b>91</b>
Rose .....	<b>92</b>
Harbor Blue .....	<b>93</b>
Grey Blue .....	<b>94</b>
Royal .....	<b>95</b>
Midnight Blue .....	<b>96</b>
Cranberry .....	<b>97</b>
Dark Burgundy .....	<b>98</b>
Harvest .....	<b>99</b>
Cognac .....	<b>100</b>

**GRADE 3**

**Drama - 65% Olefin / 35% Polyester**

Grey .....	<b>D801</b>
Dusk .....	<b>D802</b>
Navy Blue .....	<b>D803</b>
Black .....	<b>D804</b>
Burgundy .....	<b>D805</b>
Sage .....	<b>D806</b>
Beige .....	<b>D807</b>
Denim Blue .....	<b>D808</b>
Wheat .....	<b>D809</b>
Tan .....	<b>D810</b>

**Jenny - 100% Polyester**

Midnite .....	<b>JN01</b>
Ebony .....	<b>JN02</b>
Slate .....	<b>JN03</b>
Russet .....	<b>JN04</b>
Canyon .....	<b>JN05</b>
Teal .....	<b>JN06</b>
Vermilion .....	<b>JN07</b>
Admiral .....	<b>JN08</b>
Spruce .....	<b>JN09</b>
Charcoal .....	<b>JN11</b>

**Mock Leather - 100% Polyvinyl Chloride**

Black .....	<b>550</b>
Chamois .....	<b>559</b>
Surf .....	<b>570</b>
Latte .....	<b>571</b>
Melon .....	<b>572</b>
Delta .....	<b>573</b>
Bronze .....	<b>574</b>
Rouge .....	<b>575</b>
Jade .....	<b>576</b>
Graphite .....	<b>577</b>
Chaps .....	<b>578</b>
Cabernet .....	<b>579</b>
Alpine .....	<b>591</b>

**Pebbles - 100% Polypropylene**

Clay .....	<b>PB01</b>
Fawn .....	<b>PB02</b>
Sea Side .....	<b>PB03</b>
Stone .....	<b>PB04</b>
Marine .....	<b>PB05</b>
Atrium .....	<b>PB06</b>
Rhapsody .....	<b>PB07</b>
Ocean .....	<b>PB08</b>
Asphalt .....	<b>PB09</b>

**Quilt - 100% Polyester**

Black .....	<b>QL10</b>
Charcoal Grey .....	<b>QL11</b>
Violet .....	<b>QL12</b>
Poppy .....	<b>QL13</b>
Navy .....	<b>QL14</b>
Marine .....	<b>QL15</b>
Wine .....	<b>QL16</b>
Mint .....	<b>QL17</b>
Forrest .....	<b>QL18</b>
Silver .....	<b>QL19</b>

**Shard - 62% Polyester / 38% Olefin**

Garnet .....	<b>SH11</b>
Bullion .....	<b>SH12</b>
Lagoon .....	<b>SH13</b>
Cypress .....	<b>SH14</b>
Java .....	<b>SH15</b>
Tempest .....	<b>SH16</b>
Arctic .....	<b>SH17</b>
Carbon .....	<b>SH18</b>

**Sprinkle - 68% Olefin / 32% Polyester**

Cabernet .....	<b>S101</b>
Plum .....	<b>S102</b>
Barley .....	<b>S103</b>
Copper .....	<b>S104</b>
Sapphire .....	<b>S106</b>
Jade .....	<b>S107</b>
Stone .....	<b>S108</b>
Cobalt .....	<b>S109</b>
Black .....	<b>S110</b>
Graphite .....	<b>S111</b>

**Station - 61% Recycled Polyester / 39% Polypropylene**

Green Olive .....	<b>SN81</b>
Sterling Silver .....	<b>SN82</b>
New Silver .....	<b>SN83</b>
Wheat .....	<b>SN84</b>
Sand .....	<b>SN85</b>
Sapphire .....	<b>SN86</b>
Tomato .....	<b>SN87</b>
Copper .....	<b>SN88</b>
Marine .....	<b>SN89</b>
Night Time .....	<b>SN90</b>
Charcoal .....	<b>SN91</b>
Taupe .....	<b>SN92</b>
Milk Chocolate .....	<b>SN93</b>

**Styx - 50% Polyester / 50% Viscose**

Spun Yarn .....	
Dark Navy .....	<b>ST10</b>
Charcoal .....	<b>ST11</b>
Midnite .....	<b>ST12</b>
Indigo .....	<b>ST13</b>
Tide .....	<b>ST14</b>
Burgundy .....	<b>ST15</b>
Barn .....	<b>ST16</b>
Pine .....	<b>ST17</b>
Granite .....	<b>ST18</b>
Glory .....	<b>ST19</b>
Olive .....	<b>ST20</b>
Moss .....	<b>ST21</b>

**Time 54% Polyester / 46% Polypropylene**

Leaf .....	<b>T601</b>
Picante .....	<b>T602</b>
Bamboo .....	<b>T603</b>
Fudge .....	<b>T604</b>
Aqua .....	<b>T605</b>
Sky .....	<b>T606</b>
Atmosphere .....	<b>T607</b>
Bordeaux .....	<b>T608</b>
Steel .....	<b>T609</b>
Midnight .....	<b>T610</b>

**Traditional Vinyl - 82% Plasticized Vinyl / 18% Polyester Backing**

Oxblood .....	<b>557</b>
Wedgewood Blue .....	<b>564</b>
Forest Green .....	<b>568</b>
Black .....	<b>569</b>

**Urban - 62% Recycled Polyester / 32% Polyester**

Red Rose .....	<b>UR10</b>
Ocean Blue .....	<b>UR11</b>
Blue Bayou .....	<b>UR12</b>
Green Grass .....	<b>UR13</b>
Sandcastle .....	<b>UR14</b>
Beach Day .....	<b>UR15</b>
Boardwalk .....	<b>UR16</b>
Earth .....	<b>UR17</b>
Brown Ridge .....	<b>UR18</b>
White Sand .....	<b>UR19</b>
Granite Rock .....	<b>UR20</b>
Gravel Road .....	<b>UR21</b>
Black Coal .....	<b>UR22</b>



**GRADE 4 (FABRIC)**

**Crescent** - 100% Nylon with Teflon  
Designed to color coordinate with  
Renewal and Quantum fabrics.

Cocoa.....	<b>700</b>
Pear.....	<b>701</b>
Silver.....	<b>702</b>
Oatmeal.....	<b>703</b>
Lemon.....	<b>704</b>
Flame.....	<b>705</b>
Stem.....	<b>706</b>
Ruby.....	<b>707</b>
Raven.....	<b>789</b>
Cobalt Blue.....	<b>790</b>
Cinder Grey.....	<b>792</b>
Pine.....	<b>799</b>
Arctic.....	<b>800</b>

**Cumulus** - 60% Recycled Polyester  
/ 40% Rayon with Teflon Designed  
to color coordinate with Oxygen and  
Silhouette fabrics.

Cinnamon.....	<b>CU80</b>
Sepia.....	<b>CU81</b>
Ginger.....	<b>CU82</b>
Steamboat.....	<b>CU83</b>
Coffee.....	<b>CU84</b>
Flora.....	<b>CU85</b>
Raven.....	<b>CU86</b>
Cyan.....	<b>CU87</b>
Foliage.....	<b>CU88</b>
Port.....	<b>CU89</b>

**Imprint** - 100% Post-Consumer  
Polyester

Almond.....	<b>IM70</b>
Cork.....	<b>IM71</b>
Sand.....	<b>IM72</b>
Currie.....	<b>IM73</b>
Candy Apple.....	<b>IM74</b>
Ocean.....	<b>IM75</b>
Navy.....	<b>IM76</b>
Green Tea.....	<b>IM77</b>
Celery.....	<b>IM78</b>
Oregano.....	<b>IM79</b>
Walnut.....	<b>IM80</b>
Paprika.....	<b>IM81</b>
Graphite.....	<b>IM82</b>
Slate.....	<b>IM83</b>
Licorice.....	<b>IM84</b>

**Match** - 100% Recycled Polyester

Desert.....	<b>MT20</b>
Sand.....	<b>MT21</b>
Moss.....	<b>MT22</b>
Orange.....	<b>MT23</b>
Sunset.....	<b>MT24</b>
Blue.....	<b>MT25</b>
Wave.....	<b>MT26</b>
Green.....	<b>MT27</b>
Chocolate.....	<b>MT28</b>
Burgundy.....	<b>MT29</b>
Grey.....	<b>MT30</b>
Quarry.....	<b>MT31</b>
Black.....	<b>MT32</b>
Arctic.....	<b>MT33</b>

**Oxygen** - 60% Recycled Polyester /  
40% Rayon with Teflon Designed to  
color coordinate with Cumulus and  
Silhouette fabrics.

Cabernet.....	<b>OX01</b>
Lime.....	<b>OX02</b>
Verde.....	<b>OX03</b>
Navy.....	<b>OX04</b>
Royal.....	<b>OX05</b>
Chestnut.....	<b>OX06</b>
Wine.....	<b>OX07</b>
Nutmeg.....	<b>OX08</b>
Sable.....	<b>OX09</b>
Nero.....	<b>OX10</b>

**Quantum** - 60% Recycled Polyester  
/ 40% Rayon with Teflon Designed to  
color coordinate with Crescent and  
Renewal fabrics.

Cinder.....	<b>QU20</b>
Copper.....	<b>QU21</b>
Carmel.....	<b>QU22</b>
Cantaloupe.....	<b>QU23</b>
Paprika.....	<b>QU24</b>
Blue Haven.....	<b>QU25</b>
Forest.....	<b>QU26</b>
Raspberry.....	<b>QU27</b>
Azure.....	<b>QU28</b>
Marbles.....	<b>QU29</b>

**Renewal** - 70% Nylon / 30% Recycled  
Polyester with Teflon Designed to  
color coordinate with Crescent and  
Quantum fabrics.

Pewter.....	<b>RN30</b>
Cork.....	<b>RN31</b>
Cherry Fields.....	<b>RN32</b>
Volcanic Ash.....	<b>RN33</b>
Thunderstorm.....	<b>RN34</b>
Blue Grass.....	<b>RN36</b>
Leaf.....	<b>RN38</b>
Melon.....	<b>RN39</b>
Blueberry.....	<b>RN40</b>
Blue Bayou.....	<b>RN41</b>
Tomato.....	<b>RN44</b>
Amethyst.....	<b>RN45</b>
Ochre.....	<b>RN47</b>

**Replay** - 100% Post-Consumer Recycled  
Polyester

Taupe.....	<b>RP20</b>
Caramel.....	<b>RP21</b>
Paprika.....	<b>RP22</b>
Wine.....	<b>RP23</b>
Ocean.....	<b>RP24</b>
Navy.....	<b>RP25</b>
Pistachio.....	<b>RP26</b>
Moss.....	<b>RP27</b>
Turquoise.....	<b>RP28</b>
Teal.....	<b>RP29</b>
Autumn.....	<b>RP30</b>
Dark Chocolate.....	<b>RP31</b>
Slate.....	<b>RP32</b>
Dove.....	<b>RP33</b>
Coal.....	<b>RP34</b>

**Silhouette** - 100% Nylon with Teflon  
Designed to color coordinate with  
Cumulus and Oxygen fabrics.

Asphalt.....	<b>SL20</b>
Acorn.....	<b>SL21</b>
Indigo.....	<b>SL22</b>
Shiraz.....	<b>SL23</b>
Verdant.....	<b>SL24</b>
Bronze.....	<b>SL25</b>
Camel.....	<b>SL26</b>
Jade.....	<b>SL27</b>
Sienna.....	<b>SL28</b>
Charcoal.....	<b>SL30</b>
Claret.....	<b>SL32</b>
Hunter.....	<b>SL35</b>
Sapphire.....	<b>SL36</b>

**GRADE 4 (VINYL)**

*For availability of chair series in  
Vinyl, please contact a Global Sales  
Representative.*

**Allante** - 100% Vinyl Face / 100%  
Polyester Backing

Cadet.....	<b>A01E</b>
Light Neutral.....	<b>A02E</b>
Charcoal.....	<b>A03E</b>
Regimental Blue.....	<b>A11E</b>
Galaxy.....	<b>A13E</b>
Burgundy.....	<b>A17E</b>
Wine.....	<b>A18E</b>
Nu-Red.....	<b>A19E</b>
Elephant.....	<b>A21E</b>
Cinnamon.....	<b>A22E</b>
Beach Wood.....	<b>A23E</b>
Teak.....	<b>A24E</b>
Light Sand.....	<b>A25E</b>
Cream.....	<b>A26E</b>
Medium Beige.....	<b>A27E</b>
Light Sandlewood.....	<b>A29E</b>
Light Parchment.....	<b>A31E</b>
Sea Oyster.....	<b>A32E</b>
Espresso.....	<b>A33E</b>
Medium Neutral.....	<b>A35E</b>
Nu-Antelope.....	<b>A36E</b>
Dark Pewter.....	<b>A38E</b>
Nu-Shale.....	<b>A40E</b>
Grey.....	<b>A41E</b>
Bisque.....	<b>A42E</b>
Black.....	<b>A43E</b>
Ash.....	<b>A44E</b>
Medium Grey.....	<b>A45E</b>
Pearl Grey.....	<b>A46E</b>
White.....	<b>A48E</b>
Tundra.....	<b>A49E</b>
Harvest.....	<b>A50E</b>
Magnolia.....	<b>A51E</b>
River Blue.....	<b>A52E</b>
Meadow.....	<b>A53E</b>
Hideaway.....	<b>A54E</b>
Sea Cruise.....	<b>A55E</b>
Reef.....	<b>A56E</b>
Parrot.....	<b>A57E</b>
Khaki.....	<b>A58E</b>
Tumbleweed.....	<b>A59E</b>
Cayenne.....	<b>A60E</b>
Butterscotch.....	<b>A61E</b>
Twine.....	<b>A62E</b>
Mango.....	<b>A63E</b>

**Softhide - 100% Vinyl Face / 100%**

Polyester Backing

Canary .....	<b>S030</b>
Sahara .....	<b>S031</b>
Spice .....	<b>S032</b>
Camel .....	<b>S033</b>
Saddle .....	<b>S034</b>
Cocoa .....	<b>S035</b>
Paprika .....	<b>S036</b>
Chipotle .....	<b>S037</b>
Casablanca .....	<b>S038</b>
Orbit .....	<b>S039</b>
Tangier .....	<b>S040</b>
Atlantic .....	<b>S041</b>
Vineyard .....	<b>S042</b>
Antique .....	<b>S043</b>
Palm .....	<b>S044</b>
White Sand .....	<b>S045</b>
Smoke .....	<b>S046</b>
Onyx.....	<b>S047</b>

**GRADE 5 (RECYCLED)**

**Abstract - 100% Recycled Polyester**

Designed to color coordinate with Identity and Cocktail fabrics.  
To Be Discontinued December 31, 2014

Lemon .....	<b>AB11</b>
Silver Mint .....	<b>AB12</b>
Ripe Tomato .....	<b>AB13</b>
Rhubarb .....	<b>AB14</b>
Green Pea .....	<b>AB15</b>
Spinach .....	<b>AB16</b>
Ice Water .....	<b>AB17</b>
Blueberry .....	<b>AB18</b>
Ochre .....	<b>AB19</b>
Chocolate .....	<b>AB20</b>

**Cocktail - 100% Recycled Polyester**

Designed to color coordinate with Identity and Abstract fabrics.  
To Be Discontinued December 31, 2014

Strawberry Daiquiri .....	<b>C030</b>
Pina Colada .....	<b>C031</b>
Electric Blue .....	<b>C032</b>
Grape Juice .....	<b>C033</b>
Blueberry Soda .....	<b>C034</b>
Earl Grey .....	<b>C035</b>
Caesar .....	<b>C036</b>
Olive Green .....	<b>C037</b>
Green Tea .....	<b>C038</b>
Black Tea .....	<b>C039</b>

**GRADE 5 (RECYCLED) CONTINUED**

**Couture - 100% Post-Consumer**

Polyester

Champagne .....	<b>CE70</b>
Mocha .....	<b>CE71</b>
Pecan .....	<b>CE72</b>
Raspberry .....	<b>CE73</b>
Sapphire .....	<b>CE74</b>
Neptune.....	<b>CE75</b>
Lake .....	<b>CE76</b>
Willow.....	<b>CE77</b>
Sassy.....	<b>CE78</b>
Fudge.....	<b>CE79</b>
Persimmon.....	<b>CE80</b>
Carbon.....	<b>CE81</b>
Sterling.....	<b>CE82</b>
Peat.....	<b>CE83</b>

**Identity - 100% Recycled Polyester**

Designed to color coordinate with Abstract and Cocktail fabrics.  
To Be Discontinued December 31, 2014

Blue .....	<b>ID01</b>
Plum.....	<b>ID02</b>
Cypress.....	<b>ID03</b>
Cobalt.....	<b>ID04</b>
Poppy.....	<b>ID05</b>
Lava.....	<b>ID06</b>
Baltic.....	<b>ID08</b>
Wheat.....	<b>ID11</b>
Spring.....	<b>ID12</b>
Peridot.....	<b>ID13</b>
Garnet.....	<b>ID14</b>
Espresso.....	<b>ID16</b>
Grey.....	<b>ID17</b>

**GRADE 6**

**Presidio - 100% Nylon with Teflon**

Saffron.....	<b>PR01</b>
Light Grey.....	<b>PR02</b>
Charcoal.....	<b>PR03</b>
Loden.....	<b>PR04</b>
Persian.....	<b>PR05</b>
Mallard.....	<b>PR06</b>
Thistle.....	<b>PR07</b>
Campari.....	<b>PR08</b>
Cranberry.....	<b>PR09</b>
Eggplant.....	<b>PR10</b>
Cobalt Blue.....	<b>PR11</b>
Onyx.....	<b>PR12</b>

**GRADE 7**

**Genuine Leather/Mock Leather**

**combinations - 100% Leather / 100%**  
Polyvinyl Chloride

Black.....	<b>450/550</b>
Chamois.....	<b>459/559</b>
Surf.....	<b>470/570</b>
Latte.....	<b>471/571</b>
Melon.....	<b>472/572</b>
Delta.....	<b>473/573</b>
Bronze.....	<b>474/574</b>
Rouge.....	<b>475/575</b>
Jade.....	<b>476/576</b>
Graphite.....	<b>477/577</b>
Chaps.....	<b>478/578</b>
Cabernet.....	<b>479/579</b>
Alpine.....	<b>491/591</b>

**GRADE 10**

**Genuine Leather 100% Leather**

Black.....	<b>450</b>
Chamois.....	<b>459</b>
Surf.....	<b>470</b>
Latte.....	<b>471</b>
Melon.....	<b>472</b>
Delta.....	<b>473</b>
Bronze.....	<b>474</b>
Rouge.....	<b>475</b>
Jade.....	<b>476</b>
Graphite.....	<b>477</b>
Chaps.....	<b>478</b>
Cabernet.....	<b>479</b>
Alpine.....	<b>491</b>

**GRADE 12**

**Contract Leather 100% Leather**

Havana.....	D530
Dark Brown.....	D531
Sage.....	D532
Taupe.....	D533
Black.....	D534
Mustard.....	D535
Dark Green.....	D537
Burgundy.....	D538
Chestnut.....	D540
Charcoal.....	D541



# PANEL C.O.M REQUEST FOR APPLICATION TEST

## SEND COMPLETED FORM AND FABRIC TO:

Evolve Furniture Group  
555 Petrolia Road  
Toronto, Ontario M3J2X8  
Attn: Anne-Hedges Sharkey

Requested By: \_\_\_\_\_  
\_\_\_\_\_

Phone #: \_\_\_\_\_

Fax #: \_\_\_\_\_

Dealer/Specifier  
\_\_\_\_\_  
\_\_\_\_\_

Dealer Contact: \_\_\_\_\_

Evolve CSR: \_\_\_\_\_

Phone #: \_\_\_\_\_

Fax #: \_\_\_\_\_

## FABRIC INFORMATION

Fabric Manufacturer: \_\_\_\_\_  
\_\_\_\_\_

Color Name: \_\_\_\_\_

Color #: \_\_\_\_\_

Pattern Name: \_\_\_\_\_

Pattern #: \_\_\_\_\_

Content: \_\_\_\_\_  
\_\_\_\_\_

Weight: \_\_\_\_\_

Width: \_\_\_\_\_

Repeat Horizontal: \_\_\_\_\_

Repeat Vertical: \_\_\_\_\_

Other Comments: \_\_\_\_\_  
\_\_\_\_\_

## REQUEST FOR APPLICATION TEST (THIS REQUIRES 2 YARDS OF FABRIC)

\_\_\_\_\_ Evolve Panel

\_\_\_\_\_ Evolve Tackboard

\_\_\_\_\_ OH Doors

Total Number of yards for testing: \_\_\_\_\_

Please Note:

Evolve is not responsible for the duty and brokerage fees for C.O.M. Fabric to clear customs. These charges will be billed to the dealer on a separate invoice.

# PANEL FABRIC SPECIFICATION SHEET

**SEND COMPLETED FORM TO:**

EVOLVE Furniture Group  
 555 Petrolia Road  
 Toronto, Ontario M3J2X8  
 Attn: Anne Hedges-Sharkey

<b>SUPPLIER</b>  <b>PATTERN</b>  <b>WIDTH</b>  <b>CONTENT</b>	<b>REMARKS:</b> _____ _____ _____ _____	
<b>LIGHT FASTNESS</b>  <b>FLAMMABILITY</b>  <b>TUNNER TEST</b>	<b>REMARKS:</b> _____ _____ _____ _____	
<b>CUT PRICE</b>  <b>1 - 3 ROLLS</b>  <b>4 ROLLS</b>	<b>REMARKS:</b> _____ _____ _____ _____	
<b>DIRECTIONAL</b>  <b>PANELS CORNERS</b>  <b>RACEWAY COVER</b>  <b>RACEWAY CORNERS</b>  <b>STRETCH</b>	<b>REMARKS:</b> _____ _____ _____ _____	<b>EASY</b> <b>HARD</b> <b>X-HARD</b>
<b>APPROVED</b> <input type="checkbox"/> <b>NOT APPROVED</b> <input type="checkbox"/> <b>CONDITIONAL APPROVAL</b> <input type="checkbox"/>		
<b>REMARKS:</b> _____ _____ _____		
* This fabric is approved for upholster-ability only. The approval does not account for the durability of the fabric at the time of, and after installation of the product		
<b>SIGNATURE:</b> _____ <b>PRINT NAME:</b> _____ <b>DATE:</b> _____		





**TOP**

**STAPLE  
MINIMUM 6" X 6"  
FABRIC SAMPLE HERE  
IN THE DIRECTION IT IS TO BE  
APPLIED TO THE PRODUCT**

**BOTTOM**



# APPENDIX

The Evolve Furniture Group has partnered with the software vendors listed below to provide you with an online source for viewing the 2014 Evolve Electronic Catalog. Please visit their websites for additional information and download details.

## **2020 Technologies**

www.2020technologies.com  
5503 Mile Road NW  
Grand Rapids, MI 49544  
Phone: 800-638-6002

## **Ice Edge Business Solutions**

www.ice-edge.com  
4001 S 700 East, Suite 450  
Salt Lake City, UT 84107  
Phone: 801-747-0373

## **KISP**

www.kisp.com  
Customer Support: 416-499-2457  
Cad Services Team: 416-499-2457 x3  
Customer Service e-mail: tellmemore@kisp.com  
CAD Services requests CadServices@kispstech.com

## **Project Matrix**

www.projectmatrix.com  
11655 Lebanon Rd.  
Cincinnati, OH 45241  
Tech Support Instant Messenger: projectmatrixtech@yahoo.com  
Phone: 513.554.1665  
Fax: 513.554.1255

## **Quintero-Smith Incorporated/Midnight Oil**

www.midnight-oil.com  
10469 Kinnard Avenue  
Los Angeles, CA 90024  
voice: 800-350-7434 (US Only)  
international: 310-478-5140  
fax: 310-478-4572  
e-mail: jimrsr@q-si.com





# TERMS & CONDITIONS

## APPLICATION OF STANDARD TERMS

Sales of Evolve products are made only on Evolve standard terms and conditions of sale which are contained in the Price Book and in Evolve's order acknowledgments. These standard terms and conditions may be modified or supplemented only by a separately written document signed by Evolve's authorized personnel at its head office in Marlton, New Jersey. An offer by Purchaser of said terms and conditions shall not be binding until accepted by Evolve in writing.

All illustrations, specifications and prices in this Price List are based on the latest product information available at the time of publication. Evolve reserves the right to make changes, at any time and without prior notice, to prices, colors, materials, specifications and models offered.

## PRICES AND PAYMENT

The prices shown in this Price List, as well as those quoted by Evolve, shall be in US dollars for orders shipped to destinations within the continental United States.

Prices listed herein are for standard product. Quotations for special product are available through Evolve Customer Support Department in Marlton, New Jersey.

If shipping date requested is more than 90 days from date of order Evolve shall use published list prices effective at the time of shipment.

Not included in the list price are special or export packing, unpacking and installation. Orders are invoiced at the time of shipment. The Customer agrees to pay a charge of 2% per month of invoices outstanding more than 30 days.

## FOR PAYMENTS ONLY, MAIL TO:

Evolve Furniture Group, a division of:  
Global Industries, Inc.  
17 West Stow Road  
P.O. Box 562  
Marlton, New Jersey 08053

Any products sold shall remain the property of Evolve until fully paid for in cash. The Purchaser agrees to perform all acts which may be necessary to perfect and assure retention of title to such products to Evolve until such time as the goods have been paid for in full.

Freight charges will be prepaid by Evolve to destinations within the contiguous United States on orders of \$10,000 list and greater. For purchase orders less than \$10,000 list, the freight charge will be 5% of the total list price.

Please note exception below:

**All showroom and mock-up orders will be subject to actual freight charges.**

Evolve shall, in its sole discretion, determine the most appropriate method of shipment routing and carrier. Shipments of less than a full trailer load (LTL) shall ship via common carrier. **These LTL shipments are not subject to specific delivery days or times.** Full trailer loads will provide for dedicated delivery time and schedule. Purchaser may request special packaging or method of shipment at Purchaser's sole expense.

## TAXES

All sales, use, excise and other applicable taxes and the collection and reporting thereof (excluding only taxes on the net income of Evolve) are the Purchaser's responsibility and will be invoiced to the Purchaser. If Purchaser claims an exemption from such taxes, it shall be the Purchaser's responsibility to furnish an appropriate exemption certificate to Evolve.

## ORDER INFORMATION

Evolve requires that **all orders be submitted in writing** to avoid errors and/or duplication. Orders will be acknowledged with Evolve's acknowledgement forms governing the transaction. The details appearing on the acknowledgement will describe the items to be shipped to Purchaser who must ascertain that they are correct. If not correct, Purchaser should notify Evolve immediately by telephone or fax followed by written confirmation. Acknowledgment shows approximate shipping date of items ordered. **Shipping dates are assigned to orders based on the item having the longest manufacturing lead time.** Orders with Customer's Own Material (C.O.M.), or missing or incorrect information (finish selections, fabric selections, etc.) will be scheduled for manufacturing upon receipt of COM or correct complete information. Purchaser must indicate if multiple shipping schedules are required including noting if the shipping date requested is longer than standard posted lead time. Each shipment will be invoiced at time of shipping and will be subject to payment terms described herein.

## C.O.M. CUSTOMER'S OWN MATERIAL

Should Purchaser request a fabric, not standard to the Evolve upholstery line, Purchaser shall submit a sample of not less than two yards for approval. Evolve will determine whether fabric is suitable to manufacturing process and applicable UL or code requirements. Should Evolve be required to test such fabric, it shall so advise Purchaser, and Purchaser shall be responsible for all costs associated therewith. This includes all duty and brokerage fees.

Fabric yardage requirement will be determined by Evolve. An additional charge may be made to cover the cost of cutting, matching or sewing unusual or directional patterns. Evolve shall have no responsibility for condition, quality, performance, physical properties or any other aspect of C.O.M. For panels, price as if grade 1 fabric is used.

Evolve reserves the right to reject any C.O.M. deemed unsuitable.

Evolve reserves the right to cancel an order at any time if C.O.M. is, in the sole judgement of Evolve, inadequate for any reason.

## CHANGES AND CANCELLATION

The order may not be changed or cancelled by Purchaser without the written consent of Evolve. This charge can be as much as 100% based upon proximity to scheduled shipment date. Special order items and fabric-covered items already in production are not subject to change or cancellation under any circumstances. Fabric-covered items are considered to be in production once the fabric has been cut.

## DEPOSIT ON SPECIAL ORDERS

Orders for nonstandard products may, at Evolve's discretion, require deposit prior to scheduling of production, the amount of the deposit being credited against the total price of the project.

## SUSPENSION

In the event that the Purchaser defaults in the payment of any sum due Evolve, or in the event the Purchaser's financial condition becomes unsatisfactory to Evolve, Evolve shall have the right at its option, upon written notice to the Purchaser, to cancel shipment of any goods, unless within ten (10) days of Purchaser's receipt of such notice Purchaser provides assurance of payment to Evolve in such form, content and/or amounts as Evolve, in its sole discretion, deems adequate.

## COMBINED SHIPMENTS

Evolve will make every effort to combine shipments and orders on written request. However, acceptance of such request shall be with Evolve's sole discretion.

## CODE RESTRICTIONS

Evolve portable furniture may be subject to local fire, electrical and/or building codes applicable to portable furniture. It shall be Purchaser's sole responsibility for the proper application of Evolve items within the limitations of such local codes, which may be different from area to area.

## SERVICE

Service problems shall be handled by the authorized Evolve dealer. Where this cannot be accomplished on a local level, service problems should be referred to:

Evolve Furniture Group  
Customer Support  
17 West Stow Road  
Marlton, New Jersey USA 08053  
856-552-4000 888-827-2500  
Attention: Evolve Operations Manager



# TERMS & CONDITIONS

## STORAGE

In the event Purchaser requests postponement of delivery beyond the acknowledged shipping date, Evolve may transfer the goods to storage on Purchaser's account and at Purchaser's risk and expense subject to a daily storage rate. Such transfer to storage shall be deemed shipment to Purchaser for all purposes, including invoicing and payment.

## DELAYS

Evolve's order acknowledgement will state a shipping date which is Evolve's best estimate at the time the order is acknowledged. However, Evolve shall not incur any obligation or liability to Purchaser for failure to ship by a specified date. In addition, Evolve shall not be liable for any loss or damage resulting from any delay or failure in shipment or other failure to perform all or any part of the agreement between the parties with respect to the goods shown on the face of the order acknowledgement where such delay, failure, loss or damage is the proximate result of any act of any governmental authority or political subdivision thereof, revolution, riot, civil disorder or disturbance, act of enemies, delay or default in transportation, strike disputes among or between unions or other labor disputes, delay or inability in obtaining materials and facilities, fire, flood, act of God or any cause not within the reasonable control of Evolve, whether of the class of causes enumerated or otherwise. Without limiting the generality of the foregoing, Evolve may, without causing any breach or incurring liability, allocate goods which are in short supply, regardless of the reasons therefore, among purchasers, in any manner which Evolve, in its sole discretion, deems advisable.

## BACK CHARGES

Evolve will not accept charges for expense incurred by the Purchaser in expediting shipments or otherwise. Evolve will not accept charges for the repair of damage by others.

## CLAIMS

All goods are sold F.O.B. Toronto, Canada, unless otherwise agreed to in writing by Evolve. Evolve is not responsible for damage which occurs in transit or in storage. The carrier signs for all goods received in good order. It is the Purchaser's responsibility to examine goods upon receipt and to file any claims with the carrier. Any claims made against Evolve for apparent defects, errors or shortages must be made by the Purchaser in writing, within fifteen (15) working days after any delivery. Failure by the Purchaser to make any claim against Evolve within the above-described ten days shall constitute acceptance of the goods and a waiver of any apparent defects, errors or shortages.

## RETURNS

No returns of goods will be accepted without written consent and shipping instructions, including Evolve's Return Goods Authorization (R.G.A.) numbers, to Evolve. A minimum restocking charge of 35% is made on all authorized returns for credit or refund, provided goods are received by Evolve in the condition in which they left the factory. No credit will be given if goods cannot be reused. Special order items and fabric-covered items are in no event subject to return. All returns must be approved and authorized in writing by Evolve Customer Support, Marlton, New Jersey.

## LIFETIME WARRANTY

Evolve warrants that all commercial products are free from defects in material and workmanship, for the life of the product, to the original purchaser. This warranty is made by Evolve only to original customers acquiring the product directly from Evolve's authorized dealers. The customer's sole remedy pursuant to this warranty is limited to repair or replacement of parts or product at Evolve's option. Consent from Evolve must be obtained before any warranty work is performed. This warranty shall not apply to any products which must be replaced because of normal wear and tear, negligence, abuse or "accident", shipping damage, or product use and installation other than in accordance with written instructions or warnings. It shall also not apply when product has been modified or altered, repaired or refurbished by someone other than Evolve or an authorized dealer or because of natural variations over which Evolve has no control. In the event of repair and/or replacement of any defective product, Evolve does not warrant matching color, grain, texture or dye lots. Evolve's warranty does not cover the cost of transportation or labor. Repair or replacement will be at Evolve's option. Evolve makes no warranty that any of its products are suitable for any particular purpose and makes no other warranties, expressed or implied, other than those set forth in this Price List. As codes and standards vary from one jurisdiction to another, references to compliance are solely for convenience and without any representation as to accuracy or suitability. Users must verify the suitability of such information or product for their specific application. In no event shall Evolve be liable in either tort or contract for any loss or direct, special, incidental, consequential, or exemplary damages.

This Lifetime Warranty is NOT applicable to customers who use Evolve products for rental purposes and is effective only for products, parts or components manufactured after January 1, 2011.

Exceptions to this warranty include:

- Global fabrics and wood veneers, which are warranted for five years from date of delivery.
- Electrical components, which are warranted for ten years from the date of delivery.
- Moving parts such as glides, slides, casters, user-adjustable worksurface mechanisms, which are warranted for five years from date of delivery.

- Fading on fabric and wood veneers can be caused by exposure to U.V. rays/sunlight. Natural wood veneer, being a natural material, will have shade differences between veneer sheers, the difference will be more apparent between dye lots.

Evolve does not warrant color fastness on Customer's Own Material.

Because of natural variations over which Evolve has no control, this warranty does not extend to color, grain or texture of wood, and Evolve does not warrant matching of color, grain or texture.

Evolve makes no warranties, including implied warranties of merchantability and fitness for a particular purpose, other than the express warranties contained herein.

## LIMITATION OF REMEDY

Purchaser's sole and exclusive remedy (excluding the repair or replacement of goods for breach of the express warranty above) for any matter or claim arising under or relating to these terms and conditions, the goods covered hereby and any transaction involving or relating to such goods, whether in contract, tort (including negligence) or otherwise, shall be payment of the lesser of the cost to repair or replace said product or the purchase price for the goods to which the claim relates. In no event shall Evolve be liable for any special, indirect, consequential, or incidental damages, including without limitation, damages for loss of business profits, business interruptions, or loss of information.

## EVOLVE'S WARRANTY DOES NOT APPLY (FOR ANY PRODUCT CATEGORY) TO THE FOLLOWING:

- Failures due to wear and tear
- Failures which result from negligence, abuse, accident or misuse
- Failure to apply, install or maintain products according to Evolve's written instructions and warnings
- Modifications, attachments or repair methods not approved by Evolve
- Damage caused by a carrier in transit, or delivery/installation contractors
- The matching of colors, grains or textures (wood, leather, etc.) of natural materials and color matching of textiles
- Products exposed to extreme hot or cold temperatures or excessively dry or humid environments
- Colorfastness or the matching of color of textiles
- Damage by markings or staining; damage by sharp objects or imprinting from instruments
- Damage to textiles or laminate and wood surfaces/edges from exposure to sunlight (including UV rays)
- Products used for rental purposes

Evolve's warranty applies to products sold within the United States of America, Mexico, the Commonwealth of Puerto Rico and Canada.



At Evolve we believe it is our responsibility to protect the environment for future generations. The growing importance of reducing energy consumption and resource sustainability continues to challenge us in this ever-changing marketplace.

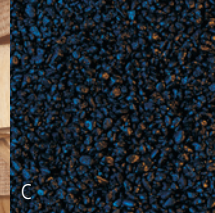

Evolve's epoxy powder coating process (A) involves no liquids and is solvent free. It does not contain any harmful VOC's or lead. Up to 99% of over sprayed powder is reclaimed, mixed with virgin powder and reused. All powder that doesn't get recirculated is recycled and used to paint non-exposed parts.

Evolve has developed a panel interior made from 100% recycled wood (B) and reclaimed polypropylene (C). Through innovative design and technology, Evolve utilizes waste that would normally have been sent to a landfill.

Evolve panels are insulated with a mineral wool insulation made from slag (an inert steel product) and basalt rock. This material's high density provides maximum sound absorption to reduce noise in the work environment. Mineral fiber insulation is fire resistant, water repellent and will not support the growth of fungi or mildew.

Evolve offers fabrics that are made from 100% recycled polyester (D), which means less waste going into landfills, reduced demand for petroleum products, and fewer environmental impacts from the processing of petroleum products into polyester.

Evolve is Level 2 and Greenguard® certified to rigorous indoor air quality standards for low-emitting interior products and manufactured in ISO 14001 registered facilities.



**Evolve Furniture Group**

17 West Stow Rd. P.O. Box 562 Marlton, New Jersey USA 08053 T 856•552•4000 888•827•2500 F 856•552•4001 [evolvefurnituregroup.com](http://evolvefurnituregroup.com)

